

CATÁLOGO 2024

CATALOGUE
2024



ARCOS®

ARCOS[®]
Made in Spain Since 1734

Autor del documento:
Arcos Hermanos S.A.

Datos de contacto:
E-Mail: comercial@arcos.com
Página Web: www.arcos.com
Teléfono: +34 967 210 261

Fecha: 01-01-2024
Diseño: Arcos Hermanos S.A.
Fotografía: Arcos, Neón Fotografía, Casanova
Impresión: Gráficas Cano

Licencia del documento:
Copyright © 2024, Arcos Hermanos S.A.

Los logos y marcas anunciados o referidos en este documento son propiedad de sus respectivos dueños.



Papel procedente de fuentes responsables.
Para más información www.fsc.org

- 10** **ARCOS, 290 AÑOS**
ARCOS, 290 YEARS // ARCOS, 290 ANS // ARCOS, 290 ANNI // ARCOS, 290 ANOS
- 22** **NOVEDADES**
NOVELTIES // NOUVEAUTÉS // NOVITÀ // NOVIDADES
- 32** **CUCHILLOS**
KNIVES // COUTEAUX // COLTELLERIA // FACAS
- 144** **NAVAJAS**
PROFESSIONAL POCKET KNIVES // COUTEAUX DE POCHE PROFESSIONNELS // LAME PROFESSIONALI // FACAS POFISSIONAIS
- 146** **CHULETEROS**
STEAK KNIVES // COUTEAUX À STEAK // COLTELLERIA // FACA DE CHURRASCO
- 176** **CUCHILLOS MESA**
TABLE KNIVES // COUTEAUX DE TABLE // COLTELLERIA DA TAVOLA // FACA DE MESA
- 186** **CUBERTERÍAS**
FLATWARE // COUVERTS // POSATERIA // TALHERES
- 218** **TIJERAS**
SCISSORS // CISEAUX // FORBICI // TESOURAS
- 236** **SARTENES Y CACEROLAS**
COOKWARE // POÊLES ET CASSEROLES // PADELLE E CASSERUOLE // FRIGIDEIRAS E PANELAS
- 260** **ÚTILES**
PROFESSIONAL TOOLS // OUTILS PROFESSIONNELS // UTENSILI PROFESSIONALI // UTENSÍLIOS
- 264** **GADGETS**
- 274** **UTENSILIOS**
UTENSILS // USTENSILES // UTENSILI // UTENSÍLIOS
- 278** **COMPLEMENTOS**
ACCESSORIES FOR KNIVES // COMPLÉMENTS POUR COUTEAUX // COMPLEMENTI PER COLTELLI // COMPLEMENTOS
- 317** **SOBRE ARCOS**
ABOUT ARCOS // À PROPOS DE ARCOS // SU ARCOS // SOBRE ARCOS

290 AÑOS
DESDE 1734



Francisco de Arcos
Ana Lujana

Miguel de Arcos
María Gallardo

Primer cuchillero

1708 **JUAN DE ARCOS GALLARDO**
María de la Cuesta

ARCOS

1734 Tijeras de escritorio realizadas por Juan de Arcos Gallardo. Marcan el inicio de la trayectoria de ARCOS

There are desk scissors, made by Juan de Arcos Gallardo dating the beginning of ARCOS.

1742 **JUAN DE ARCOS DE LA CUESTA**
Ana Pastor

1778 **JUSTO ARCOS PASTOR**
Francisca Aparicio

1814 **ISIDRO ARCOS APARICIO**
Ana Aroca



1851 **LEONARDO GREGORIO ARCOS AROCA**
María Jesús Abia

G. ARCOS
ALBACETE

1878 **ROBERTO ARCOS ABIA**
Inocencia Villanueva

R. ARCOS
ALBACETE

1925 **GREGORIO ARCOS VILLANUEVA**
Luisa Galiano Blasco



1970 **ROBERTO ARCOS GALIANO**
Pedro Arcos Galiano
Ana Arcos Galiano

ARCOS
ARCOS

ARCOS
Albacete (Spain) Since 1734

2022 **ROBERTO ARCOS PÉREZ**
Sara Arcos Pérez
Luis Arcos Ríos
Marta Arcos Ríos

ARCOS
Albacete (Spain) Since 1734

UN TALLER, 290 AÑOS DE PASIÓN CULINARIA

En el rincón más acogedor de Albacete, hace 290 años, un pequeño taller cobró vida, nació la esencia de Arcos. Juan de Arcos, con su maestría, daba vida a las primeras tijeras bajo el sello distintivo de nuestra marca en 1734. Estas tijeras, más que simples herramientas, encierran la pasión, artesanía y evolución que nos ha caracterizado desde entonces. Desde aquel primer corte, Arcos ha sido más que un lugar de trabajo: un hogar donde cada cuchillo es creado con el mismo cariño y la dedicación que se encuentra en el alma de cada cocina.

Agradecemos sinceramente a todos aquellos que han compartido este viaje con nosotros, confiando en la excelencia de nuestros productos. Con la mirada puesta en el futuro, nos llena de emoción seguir siendo su elección de confianza, llevando consigo la rica tradición y la constante innovación que nos identifica. Que cada corte con un cuchillo Arcos represente un capítulo único en su viaje culinario, y esperamos seguir siendo cómplices de estas experiencias en los próximos años.

One Workshop, 290 Years of Culinary Passion.

In the cosiest corner of Albacete, 290 years ago, a small workshop came alive; the essence of Arcos was born. Juan de Arcos, with his expertise, brought the first pair of scissors alive under the distinctive sign of our brand in 1734. These scissors, more than simple tools, embodied the passion, craftsmanship and the evolution that has defined us ever since. From that first cut, Arcos has become more than just a workplace: a home where each knife is created with the tender loving care and the dedication that is found in the soul of each kitchen.

We sincerely appreciate everyone who has shared this journey with us, trusting in the excellence of our products. Looking ahead to the future, we are thrilled to still be your trusted choice, which comes with the rich tradition and the constant innovation that identifies us. Each cut with an





Fabrica de Arcos en los años 80' // Arcos Factory in the 80's

Arcos knife stands for a unique chapter in its culinary journey, and we hope to continue sharing these experiences with you all in the next few years.

Un atelier, 290 ans de passion culinaire.

Dans le quartier le plus joli d'Albacete, il y a 290 ans, un petit atelier a vu le jour : l'essence d'Arcos était née ! Juan de Arcos, avec sa maîtrise, donna vie aux premiers ciseaux sous notre marque distinctive en 1734. Ces ciseaux, qui étaient bien plus que de simples outils, résument la passion, l'artisanat et l'évolution qui nous ont toujours caractérisés. Depuis cette première découpe, Arcos est bien plus qu'un simple espace de travail : c'est un foyer où chaque couteau est créé avec autant d'amour et de dévouement qu'il y a dans l'âme de chaque cuisine.

Nous tenons à remercier chaleureusement tous ceux qui ont partagé ce voyage avec nous, confiants dans l'excellence de nos produits. Alors que nous nous tournons vers l'avenir, nous sommes ravis de continuer à être votre premier choix, portant ainsi la riche tradition et l'innovation constante qui nous identifient. Que chaque découpe avec un couteau Arcos représente un chapitre unique de votre voyage culinaire, et nous souhaitons continuer à être complices de ces expériences pour les années à venir.

Un laboratorio, 290 anni di passione culinaria.

290 anni fa, nell'angolo più accogliente di Albacete, prese vita un laboratorio nel quale nacque l'essenza di Arcos. Nel 1734, Juan de Arcos, con la sua abilità, diede vita alle prime forbici che portavano il sigillo distintivo del nostro marchio. Queste forbici sono più che semplici strumenti: racchiudono la passione, l'artigianalità e l'evoluzione che ci hanno caratterizzato sin da allora. Da quel primo taglio, Arcos è diventato molto più che un semplice luogo di lavoro: si è trasformato in una casa, nella quale ogni coltello viene

creato impiegando lo stesso affetto e la stessa dedizione che risiedono nell'anima di ogni cucina.

Ringraziamo sinceramente tutti coloro che hanno condiviso questo viaggio con noi, riponendo la loro fiducia nell'eccellenza dei nostri prodotti. Guardando al futuro, ci emoziona profondamente continuare ad essere la vostra scelta di fiducia, la quale racchiude la ricca tradizione e la costante innovazione che ci caratterizza. Ci auguriamo che ogni taglio di un coltello Arcos rappresenti un capitolo unico del vostro viaggio culinario e speriamo di poter rimanere i complici perfetti di queste esperienze negli anni a venire.

Uma Oficina, 290 Anos de Paixão Culinária

No recanto mais acolhedor de Albacete, há 290 anos, uma pequena oficina ganhou vida, nascia a essência de Arcos. Juan de Arcos, com a sua mestria, deu vida às primeiras tesouras com o selo distintivo da nossa marca em 1734. Estas tesouras, mais do que simples ferramentas, encerram em si a paixão, a mestria e a evolução que nos caracteriza desde então. Desde esse primeiro corte, a Arcos tem sido mais do que um local de trabalho: uma casa onde cada faca é criada com o mesmo amor e dedicação que está na alma de cada cozinha.

Agradecemos sinceramente a todos aqueles que compartilharam conosco este percurso, confiando na excelência dos nossos produtos. Ao olharmos para o futuro, estamos entusiasmados por continuar a ser a sua escolha de confiança, levando conosco a rica tradição e a constante inovação que nos identifica. Que cada corte com uma faca Arcos represente um capítulo único na sua viagem culinária, e nós esperamos continuar a ser cúmplices dessas experiências nos próximos anos.

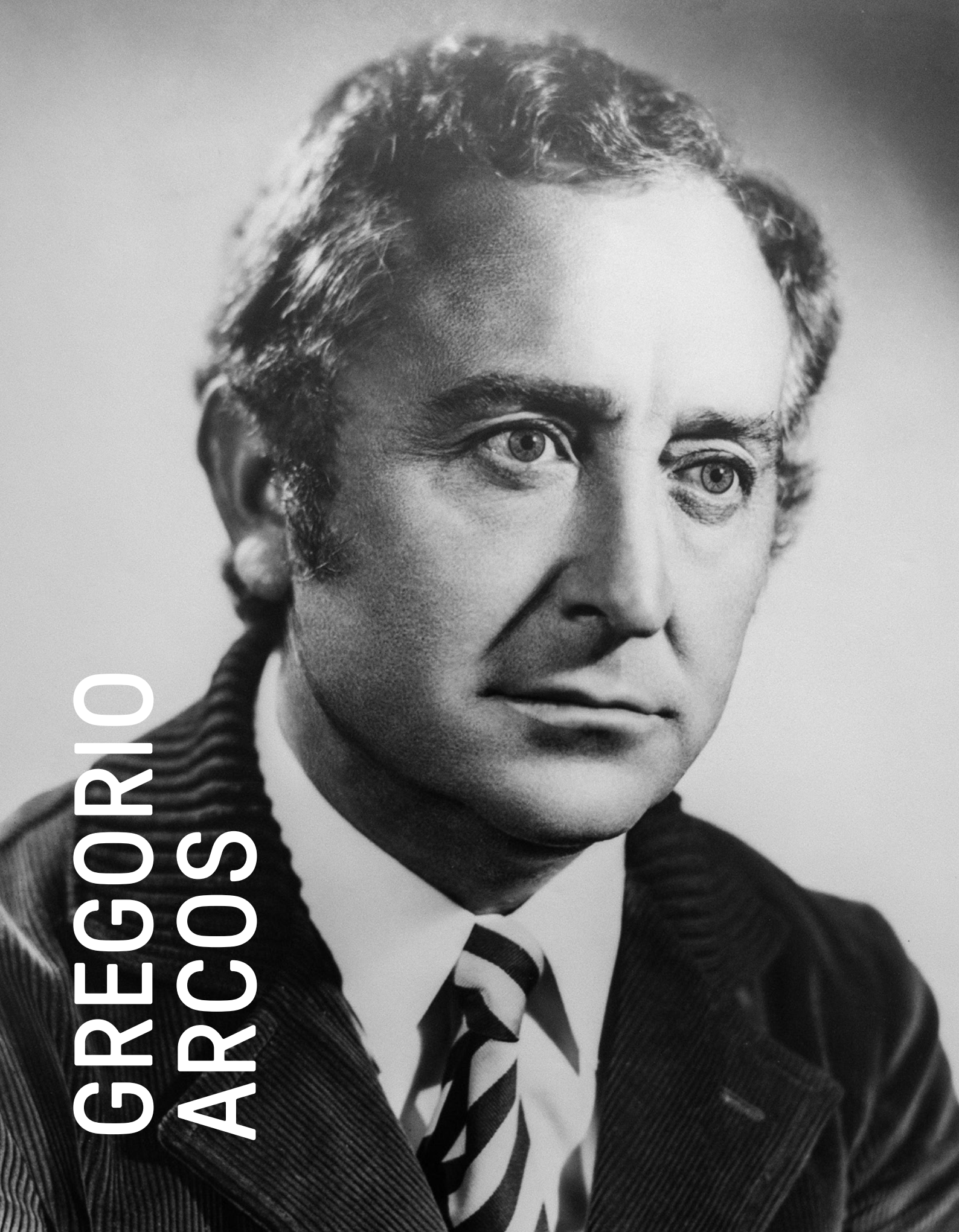

GREGORIO
ARCOS

Este año, ARCOS celebra 290 años de excelencia en arte de la cuchillería, un legado forjado con pasión, dedicación y un equipo humano único. Se trata de un aniversario especial, porque rendimos homenaje a Gregorio Arcos Villanueva. Una persona cuya influencia ha sido fundamental para dar forma a la identidad y a la esencia de ARCOS.

Desde muy temprana edad, Gregorio se entregó de lleno y con entusiasmo a la industria de la cuchillería, infundiendo en ARCOS una mentalidad innovadora y un compromiso inquebrantable con la calidad. Su liderazgo nos llevó más allá de las fronteras de la tradición, explorando nuevos horizontes y oportunidades.

Bajo su sabia dirección, ARCOS también se aventuró en una valiente travesía hacia la internacionalización, llevando nuestra marca y valores a través de fronteras y cocinas de todo el mundo. Cada cuchillo, cada pieza es única y cuenta una historia global, fabricada por manos y culturas diversas, siempre guiada por la visión emprendedora de Gregorio.

Hoy, celebramos los logros, las relaciones y las tradiciones que hemos cultivado juntos. Rindiendo tributo al legado de Gregorio, ARCOS perpetúa su pasión y visión, avanzando con firmeza en el camino de la mejora e innovación global. Unidos, seguimos forjando esta historia de evolución y éxito.

This year, ARCOS celebrates 290 years of excellence in knife making craftsmanship, a legacy forged with passion, dedication and a strong community. On this special anniversary, we pay tribute to Gregorio Arcos Villanueva, whose influence has been fundamental in shaping the identity and the spirit of ARCOS.

From an early age, Gregorio dedicated himself to the revered art of knife making, instilling an innovative mentality and an unwavering commitment to quality in ARCOS. His leadership has led us beyond the frontiers of tradition, by exploring new horizons and opportunities.

Under his wise management, ARCOS also set off on a brave voyage towards internationalization, taking our brand and values over borders and through hearts across the world. Each knife, each masterpiece, has a global story, touched by different hands and cultures, guided by the inclusive and enterprising vision of Gregorio.

Today, we are celebrating the achievements, the relationships and the traditions that we have worked on together. By paying tribute to the legacy of Gregorio, ARCOS perpetuates his passion and vision, steadily making progress on the way towards global improvement and innovation. United, we continue to build on this story of evolution and success.

Cette année, ARCOS célèbre 290 ans d'excellence dans l'art de la coutellerie, un héritage forgé avec passion, dévouement et une équipe humaine exceptionnelle. C'est un anniversaire particulier car nous rendons hommage à Gregorio Arcos Villanueva. Une personne dont l'influence a été fondamentale pour façonner l'identité et l'essence d'ARCOS.

Depuis son plus jeune âge, Gregorio s'est pleinement investi dans l'industrie de la coutellerie, insufflant à ARCOS une mentalité innovante et un engagement indéfectible envers la qualité.

Sous sa direction éclairée, ARCOS a également entrepris une audacieuse aventure vers l'internationalisation, portant notre marque et nos valeurs à travers les frontières et les cuisines du monde entier. Chaque couteau, chaque pièce est unique et raconte une histoire mondiale, façonnée par des mains et des cultures diverses, toujours guidées par la vision entrepreneuriale de Gregorio.

Aujourd'hui, nous célébrons les réalisations, les relations et les traditions que nous avons cultivées ensemble. En rendant hommage à l'héritage de Gregorio, ARCOS perpétue sa passion et sa vision, progressant résolument sur le chemin de l'amélioration et de l'innovation à l'échelle mondiale. Unis, nous continuons à façonner cette histoire d'évolution et de succès.

Quest'anno ARCOS festeggia 290 anni di eccellenza nell'artigianato della coltelleria, un retaggio forgiato con passione, dedizione e una forte comunità. In questo speciale anniversario rendiamo omaggio a Gregorio Arcos Villanueva, la cui influenza è stata fondamentale per plasmare l'identità e lo spirito di ARCOS.

Fin dalla sua giovane età, Gregorio si è dedicato completamente alla venerabile arte della coltelleria, instillando in ARCOS una mentalità innovatrice e un impegno indefettibile per la qualità. La sua leadership ci ha portati a superare le barriere della tradizione, per esplorare nuovi orizzonti e nuove opportunità.

Sotto la sua guida, ARCOS ha potuto avventurarsi anche in un coraggioso viaggio verso l'internazionalizzazione, che ha portato il nostro marchio e i nostri valori ad attraversare frontiere e cuori in tutto il mondo. Ogni coltello, ogni opera d'arte, racconta una storia globale, toccata da mani e culture diverse, guidata dalla visione inclusiva e imprenditrice di Gregorio.

Oggi festeggiamo i successi, i rapporti e le tradizioni che abbiamo coltivato assieme. Nel rendere omaggio al retaggio di Gregorio, ARCOS tramanda la sua passione e la sua visione, addentrandosi fermamente nel cammino del miglioramento e dell'innovazione globale. Assieme continuiamo a forgiare questa storia intrisa di sviluppo e successo.

Este ano, a ARCOS celebra 290 anos de excelência no fabrico de cutelaria, um legado forjado com paixão, dedicação e uma comunidade forte. Neste aniversário especial, prestamos homenagem a Gregorio Arcos Villanueva, cuja influência foi fundamental para moldar a identidade e o espírito da ARCOS.

Desde muito cedo, Gregorio dedicou-se à venerada arte da cutelaria, infundindo na ARCOS uma mentalidade inovadora e um compromisso inabalável com a qualidade. A sua liderança levou-nos para além das fronteiras da tradição, explorando novos horizontes e oportunidades.

Sob a sua sábia orientação, a ARCOS também se aventurou numa corajosa viagem rumo à internacionalização, levando a nossa marca e os nossos valores para além das fronteiras e dos corações de todo o mundo. Cada faca, cada obra-prima, conta uma história global, tocada por diversas mãos e culturas, guiada pela visão inclusiva e empreendedora de Gregorio.

Hoje, celebramos as conquistas, relações e tradições que cultivámos juntos. Prestando homenagem ao legado de Gregorio, a ARCOS perpetua a sua paixão e visão, avançando com firmeza no caminho da melhoria e inovação globais. Juntos, continuamos a forjar esta história de evolução e sucesso.



Fotografía antigua cuchillo chuletero 3715. Diseñado por Gregorio Arcos en los años setenta. Más información en la página 160. // Vintage photograph of the steak knife 3715. Designed by Gregorio Arcos in the seventies. More information on page 160.

ICONOGRAFÍA

NEW

Nuevo // New // Nouveau // Nouvo // Novo



Perlado // Serrated // Cranté // Seghettato // Perolado



Microperlado // Micro-Serrated // Microcranté
Micro-Seghettato // Micro-Perolado



Madera Comprimida // Pack Wood // Bois Compressé
Legno Compresso // Madeira comprimida



Antideslizante // Non-slip // Antidérapant // Antiscivolo
Antiderrapante



Resistente a altas temperaturas // High-Temperature
Resistan // Résistant Aux Hautes températures
Resistente Alle Alte Temperature // Resistente a Altas
Temperaturas.



Remaches // Stainless Steel Rivets // Rivets en
Acier Inoxydable // Rivetti in Acciaio Inossidabile
Rebites de Aço Inoxidável.



Remaches Anticorrosión // Anti-corrosion rivets
Rivets anticorrosion // Rivetti in Rivetti anticorrosione
Rebites anticorrosão.



Hoja // Blade // Lame // Lama // Lâmina
Mango // Handle // Manche // Manico // Cabo



Presentación // Presentation // Présentation
Presentazione // Apresentação



Materiales // Materials // Matériaux // Materiali
Materiais



Cuchillos Estilo Japonés // Japanese Style Knives
Couteaux Style Japonais // Coltelli Stile Giappones
Facas Japonesas



Canal para líquidos // Liquid channel // Avec Rigole
Scanalatura per Liquidi // Canal para Líquidos



Hueco salsaera // Gravy Boat Hole // Emplacement Sauce
Foro salsiera // Cavidade para Molho



Antideslizante // Non-Slip // Antidérapant // Antiscivolo
Antiderrapante



FORJADO · FORGED · FORGÉ · FORGIATO · FORJADO

Sometido al proceso de forja al rojo vivo que tiene como resultado un cuchillo macizo de una sola pieza a través de un moldeado perfecto.
Submitted to red-hot forging process which results in a solid single-piece knife through a flawless moulding.
Soumis au processus de forgeage à chaud ayant pour résultat un couteau massif d'une seule pièce grâce à un moulage parfait.
Sottoposto al processo di forgiatura al rosso vivo, il cui risultato è un coltello massiccio, in un solo pezzo, mediante uno stampaggio perfetto.
O processo de forjamento a quente resulta numa faca sólida e de uma só peça através de uma moldagem perfeita.



FILO SEDA · SILK EDGE · SILK EDGE · FILO SETA · FIO SEDA

El filo especial seda ha sido creado uniendo nuestra tradición y la tecnología más innovadora, obteniendo así un corte único caracterizado por su suavidad y precisión.
The special silk edge has been created by combining our tradition and cutting-edge technology, thereby obtaining a unique cut characterised by its smoothness and precision.
Le tranchant "silkedge" a été créé en conjuguant savoir faire traditionnel et technologie novatrice pour obtenir une coupe unique précise et facile.
Lo speciale filo seta è stato creato unendo alla nostra tradizione la tecnologia più innovatrice, per ottenere un taglio unico, caratterizzato dalla sua morbidezza e precisione.
O fio especial seda foi criado combinando a nossa tradição e a tecnologia mais inovadora, obtendo assim um corte único caracterizado pela sua suavidade e precisão.



RECAZO REDONDEADO · ROUNDED BACK · DOS DE LAME ADOUCI · COSTOLA ARROTONDATA · DORSO ARREDONDADO

Borde superior de la hoja que proporciona una suavidad en el uso, evitando roces en la mano.
Upper edge of the blade which provides a smoothness when used avoiding hand chafing and abrasions.
Dos des lames arrondis pour plus de confort et de douceur lors de manipulation.
Il bordo superiore della lama fornisce morbidezza d'uso ed evita attriti sulla mano.
O dorso da lâmina proporciona uma suavidade na utilização, evitando o atrito na mão.



NITRUM®

Fórmula exclusiva de acero al nitrógeno que proporciona más dureza, mayor poder de corte y mejora la durabilidad del filo.
Its exclusive nitrogen treated steel composition provides additional hardness, greater cutting power and improved cutting edge durability.
Formule exclusive en acier à l'azote pour avantage de dureté, un plus haut pouvoir de coupe et un tranchant plus résistant.
Formula esclusiva di acciaio al nitrogeno che conferisce maggiore durezza, più potere di taglio, e aumenta la durata del filo.
Fórmula exclusiva de aço com nitrogênio que proporciona maior dureza, maior poder de corte e melhora a durabilidade do fio.



INYECCIÓN · INJECTION · INJECTION · INIEZIONE · INVECCÃO

El mango se solidifica alrededor de la espiga del cuchillo consiguiendo un conjunto de hoja-cuchillo sólido, robusto e inseparable.
The handle is solidified around the tang of the knife obtaining an integrated, solid and sturdy knife-blade set.
Le manche est solidement intégré à la soie du couteau, créant ainsi un ensemble lame-couteau solide, robuste et indissociable.
Il manico si solidifica attorno al codolo del coltello, ottenendo un'unione tra lama e coltello solida, robusta e inseparabile.
O cabo é solidificado em torno do ricasso da faca para um conjunto lâmina faca sólido, robusto e inseparável.



DOBLE INYECCIÓN · DOUBLE INJECTION · DOUBLE INJECTION · DOPPIA INIEZIONE · INJECCÃO DUPLA

Mango compuesto por dos materiales diferentes que otorga al cuchillo resistencia y comodidad para el uso prolongado.
A handle composed of two different materials which endows the knife with resistance and comfort for prolonged use.
Manche composé de deux matériaux différents pour obtenir un couteau résistant et confortable pour un usage prolongé.
Manico composto da due materiali diversi che conferiscono resistenza al coltello e garantiscono il comfort in caso di uso prolungato.
O cabo é feito de dois materiais diferentes que dão à faca resistência e conforto para uma utilização prolongada.



PLÁSTICOS TÉCNICOS · TECHNICAL PLASTICS · PLASTIQUES TECHNIQUES · PLASTICHE TECNICHE · PLÁSTICOS TÉCNICOS

Plásticos técnicos de uso alimentario que otorgan al mango del cuchillo alta resistencia química, mecánica y alta durabilidad.
Technical plastics for food use, which provide the knife handle high chemical and mechanical resistance and great durability.
Plastiques techniques à usage alimentaire dotent le manche du couteau d'une haute résistance chimique, mécanique et d'une grande durabilité.
Plastiche tecniche ad uso alimentare, che dotano il manico del coltello di un'alta resistenza chimica, meccanica e un'alta durevolezza.
Plásticos técnicos de uso alimentar que conferem ao cabo da faca uma elevada resistência química, mecânica e uma grande durabilidade.



NSF (National Sanitary Foundation)

Avalado por la prestigiosa certificación norteamericana NSF (National Sanitary Foundation) Sobre la salud alimentaria.
Endorsed by the prestigious North American NSF (National Sanitary Foundation) certification on food safety.
Ayant reçu la prestigieuse certification américaine NSF (National Sanitary Foundation) relative à la santé alimentaire.
Garantito dalla prestigiosa certificazione americana NSF (National Sanitary Foundation) sulla salute alimentare.
Avalizada pela prestigiada certificação norte-americana NSF (National Sanitary Foundation) para a segurança alimentar.



ICE PLUS®

Tratamiento térmico a -80°C aplicado al acero inoxidable que le proporciona especial resistencia al desgaste.
-80°C Heat treatment applied to the stainless steel offering special resistance against wear and tear.
Traitement thermique à -80°C appliqué sur l'acier inoxydable pour une résistance supérieure à l'usage.
Trattamento termico a -80°C applicato all'acciaio inox che conferisce una particolare resistenza all'usura.
Tratamento térmico a -80°C aplicado ao aço inoxidável, o que lhe confere uma resistência especial ao desgaste.



BACTIPROOF SILVER®

Sistema anti-bacteriano aplicado al mango que reduce en un 99,9% la presencia de bacterias, hongos o moho.
An anti-bacterial system combination applied to the handle which reduces by 99.9% the presence of bacteria, fungi or mould.
Système anti-bactéries appliqué au manche, assurant une réduction de la présence de bactéries, de champignons et de moisissure de 99,9 %.
Sistema anti-batterico applicato al manico che riduce del 99,9% la presenza di batteri, funghi o ruggine.
Um sistema antibacteriano aplicado ao cabo que reduz a presença de bactérias, fungos ou bolores em 99,9%.



MANGO DE MICARTA · MICARTA HANDLE · MANCHE EN MICARTA · MANICO DI MICARTA · PUNHO MICARTA

Tela prensada con resina. Material duro y resistente a temperaturas elevadas y humedad ambiental.
Resin pressed composition. Rigid material and resistant to high temperatures and ambient humidity.
Tissus pressés avec de la résine. Matériau dur et résistant aux hautes températures et à l'humidité ambiante.
Tela pressata con resina. Materiale duro e resistente alle temperature elevate e all'umidità ambientale.
Tecido prensado com resinas, material duro e resistente a altas temperaturas e humidade.



MANGO DE MADERA · WOOD HANDLE · MANCHE EN BOIS · MANICO DI LEGNO · PUNHO DE MADEIRA

Madera 100% natural / Moldeada
100% natural wood / Carved
Bois 100 % naturel / Modélisé
Legno 100% naturale / Modellato
Madeira 100% natural / Moldada

PROCESOS Y MATERIALES

MATERIALS AND PROCESSE • PROCESSUS ET MATÉRIAUX
PROCEDIMENTI E MATERIALI • PROCESSOS E MATERIAIS



10 YEAR GUARANTEE

BROOKLYN

MANHATTAN

ÓPERA

NÓRDIKA

RIVIERA

RIVIERA BLANC

CLARA

UNIVERSAL HOME

MAITRE

NIZA

LÍNEA

LATINA

NOVA











KIDS

ATLÁNTICO

UNIVERSAL PRO

COLOUR PROF

2900

			NITRUM®										
					Natural Natural Naturale Natural	Moldeada Carved Modellato Moldada	Inyección Injection Iniezione Injeção	Doble Inyección Double Injection Doppia Iniezione Injeção Dupla	Polioximetileno (POM) Polyoxymethylene (POM) Polioxymethylene (POM)	Polipropileno Polypropylene Polipropilene	REMACHES RIVETS RIVETTI REBITES	NSF	
●	●	●	●	●							●		
●	●	●	●						●		●	●	●
●	●	●	●						●		●	●	
	●	●	●		●						●		
●			●						●		●	●	●
●			●						●		●	●	●
●			●			●				●			
			●						●		●	●	●
			●							●	●		
			●			●				●			
			●					●		●			
			●							●			
			●		●					●			
			●			●				●			
			●						●		●	●	●
			●					●		●	●	●	●
			●			●				●	●		●

PROCESOS DE FABRICACIÓN

EL TEMPLE

THE TEMPER · TREMPE · LA TEMPRA · A TÊMPERA

El temple es la fase más importante en el proceso de fabricación de una herramienta de corte. Consiste en un tratamiento térmico del acero a una temperatura alta (aprox. 1070°C), manteniéndola durante un tiempo determinado (tiempo de austenización) y, a continuación, realizando un rápido enfriamiento a temperatura ambiente, obteniendo de este modo la transformación de la estructura molecular del acero (reacción martensítica), que se manifiesta con un aumento de la dureza del acero. La dureza es la cualidad física necesaria para obtener un buen poder y durabilidad del corte del cuchillo. Además, la correcta estructura interna del acero otorga una mayor resistencia a la corrosión. ARCOS realiza el tratamiento térmico de temple en hornos continuos de atmósfera controlada y, posteriormente, realiza un segundo tratamiento térmico –llamado revenido- que consiste en un calentamiento a 250°C, para eliminar cualquier tensión creada por el rápido enfriamiento del temple que pudiese producir fragilidad en el acero, garantizando las mismas propiedades mecánicas a lo largo de todo el filo de la herramienta.

The temper is the most important phase in the manufacturing process of a cutting tool. It consists of a thermal treatment of steel to a high temperature (around 1070°C), keeping it during a certain time (time of austenization) and then, carrying out a quick cooling up to room temperature, obtaining this way the transformation of the molecular structure of the steel (martensitic reaction), which becomes evident with an increase of the hardness of the steel. Hardness is the physical necessary quality to obtain a good power and cut durability from a knife. In addition, the right internal structure of the steel grants a major resistance to corrosion. ARCOS carries out the thermal treatment of temper in constant furnaces with controlled atmosphere and, later, carries out a second thermal treatment – so-called tempering - that consists of a warming to 250°C, in order to eliminate any tension made by the rapid cooling of the temper that could produce fragility in the steel, granting the same mechanical properties along the whole edge of the tool.

La trempe est la phase la plus importante du processus de fabrication d'un outil de coupe. La trempe ou trempage consiste à traiter thermiquement un matériau : l'acier est chauffé à une température élevée jusqu'à obtenir la température d'austénisation (environ 1070 °C), puis maintenu en température durant un temps déterminé (temps d'austénisation), un refroidissement rapide est ensuite réalisé, afin d'obtenir la transformation de la structure moléculaire de l'acier (réaction martensitique), qui se manifeste par une augmentation de la dureté de l'acier. La dureté est la qualité physique nécessaire à l'obtention d'un bon pouvoir et d'une bonne durabilité de coupe du couteau. De plus, une bonne structure interne de l'acier confère une meilleure résistance à la corrosion. ARCOS réalise le

traitement thermique de trempe dans des fours continus à atmosphère contrôlée et, postérieurement, réalise un second traitement thermique, appelé reveni, qui consiste à chauffer la pièce à 250 °C, afin de réduire les contraintes internes créées durant la trempe susceptibles de fragiliser l'acier, garantissant les mêmes propriétés mécaniques tout le long du fil de l'outil.

La tempra è la fase più importante nel processo di fabbricazione di un utensile da taglio. Consiste nel trattamento termico dell'acciaio a una alta temperatura (circa 1070°C) e che viene mantenuta durante un tempo determinato (tempo di austenizzazione) e, in seguito producendo un rapido raffreddamento a temperatura ambiente, ottenendo in questo modo la trasformazione della struttura molecolare dell'acciaio (reazione martensitica) che si manifesta ottenendo un aumento della durezza dell'acciaio. La durezza è la qualità fisica necessaria per ottenere un buon potere e una durabilità nel tempo del taglio del coltello. Inoltre, la corretta struttura interna dell'acciaio ottiene una maggiore resistenza alla corrosione. ARCOS realizza il trattamento termico della tempra in forni continui ad atmosfera controllata, realizza una seconda fase di trattamento termico – chiamato rinvenimento – consistente in un riscaldamento fino a 250°C per eliminare qualsiasi tensione che potrebbe determinarsi con il raffreddamento rapido durante il processo di tempra, che può produrre fragilità nell'acciaio, garantendo le stesse proprietà meccaniche per tutta la lunghezza del filo dell'utensile.

A têmpera é a fase mais importante no processo de fabrico de uma ferramenta de corte. Consiste num tratamento térmico do aço a uma temperatura elevada (aproximadamente 1070°C), mantendo-a durante um certo tempo (tempo de austenização) e depois arrefecendo-o rapidamente à temperatura ambiente, obtendo-se assim a transformação da estrutura molecular do aço (reação martensítica), que se manifesta por um aumento da dureza do aço. A dureza é a qualidade física necessária para um bom poder de corte e durabilidade da faca. Além disso, a estrutura interna correta do aço proporciona uma maior resistência à corrosão. ARCOS realiza o tratamento térmico de endurecimento em fornos contínuos com atmosfera controlada e depois realiza um segundo tratamento térmico - chamado revenimento - que consiste no aquecimento até 250°C, a fim de eliminar qualquer tensão criada pelo rápido arrefecimento da têmpera, que poderia causar fragilidade no aço, garantindo as mesmas propriedades mecânicas ao longo de toda a lâmina da ferramenta.





FORJADO

FORGING PROCESS · LA FORGE · LA FORGIATURA
FORJADO

El proceso de forja consiste en la deformación del acero, que previamente ha sido calentado al rojo vivo, entre dos utillajes denominados “estampas de forja”, las cuales llevan grabadas la forma del cuchillo a conseguir. Para obtener dicha deformación, se utilizan prensas de gran tonelaje, ya que es necesario un fuerte golpe para conseguir que se inicie el flujo plástico del acero para deformarse y obtenerse la forma grabada en las estampas. De este proceso hay que destacar que el cuchillo resultante es macizo de una sola pieza, evitando las indeseadas zonas soldadas, pegadas o huecas que son sinónimos de cuchillos de baja calidad, porque son zonas de baja resistencia mecánica, roturas y puntos posibles de oxidación.

The process of forge consists of the deformation of the steel, which previously has been warmed to red-hot, between two tools called “prints of forge”, which have engraved the shape of the knife to be achieved. To obtain the above mentioned deformation, presses of great tonnage are used, since a strong blow is necessary to achieve that the plastic flow of the steel begins to be deformed and then becoming the form engraved in the prints. It is necessary in this process to distinguish that the resultant knife is a solid single piece, avoiding the unwanted welded, stuck and empty areas, which are synonymous of knives of low quality, because they are areas of low mechanical resistance, were breaks could be produced as well as potential points of oxidation.

Le procédé de forge consiste à déformer l'acier qui a été préalablement chauffé au rouge, entre deux outils appelés « étampes de forge », lesquelles donneront sa forme au couteau. Pour obtenir cette déformation, on utilise des presses de fort tonnage, dans la mesure où une forte pression est nécessaire pour obtenir l'écoulement plastique de l'acier qui, devenu malléable, prendra la forme donnée par les étampes. Le couteau obtenu est massif, coulé d'une seule pièce : on évite ainsi les points de soudure, de collage ou les creux indésirables qui caractérisent les couteaux de mauvaises qualité, lesquels offrent une faible résistance mécanique, ont une propension à la rupture et sont sujets à l'oxydation.

Il processo di forgiatura consiste nella deformazione dell'acciaio, che è stato preventivamente riscaldato a fuoco vivo, all'interno degli stampi denominati “stampi di forgiatura” che realizzano la forma determinata del coltello. Per ottenere questa deformazione, vengono utilizzate presse di grande tonnellaggio, in quanto è necessario un colpo forte al fine di

realizzare la fusione plastica per la deformazione dell'acciaio e ottenere in questo modo la forma prefissata dallo stampo. Con questo processo ottiene così un coltello in acciaio massiccio uniprezzo, evitando le zone saldate indesiderate, incollate o vuote, che sono indicative di bassa qualità, in quanto sono zone di bassa resistenza meccanica, con possibilità pure di rotture o punti possibili di ossidazione.

previamente aquecido em brasa entre duas ferramentas chamadas “matrizes de forjamento”, que são gravadas com a forma da faca a ser obtida. Para obter esta deformação, são utilizadas prensas de alta tonelagem, pois é necessário um forte golpe para iniciar o fluxo plástico do aço a fim de o deformar e obter a forma gravada nas matrizes. Deve-se salientar que a faca resultante é sólida numa só peça, evitando as áreas indesejáveis soldadas, coladas ou ocas que são sinónimo de facas de baixa qualidade, porque são áreas de baixa resistência mecânica, quebra e possíveis pontos de oxidação.

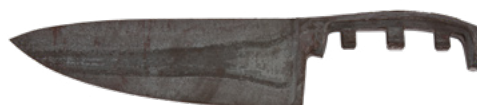

INYECCIÓN DIRECTA

DIRECT INJECTION · L'INJECTION DIRECTE
L'INIEZIONE DIRETTA · INJEÇÃO DIRETA

La inyección directa consiste en la unión de la espiga del cuchillo con el plástico del mango consiguiendo un conjunto sólido, robusto e inseparable. No existen huecos por donde pueda entrar agua o restos de alimentos, por lo que es un proceso totalmente higiénico, cumpliendo normativas de sanidad y seguridad. Se inyecta el plástico en estado líquido (180°C aprox.), en el molde. Así el plástico se solidifica alrededor de la espiga del cuchillo formando un bloque único (hoja-mango).

Direct injection consists of the union of the knife's tang with the plastic of the handle obtaining a durable, sturdy and unbreakable set. There are no gaps through which water or food remains can enter, reason why it is a completely hygienic process, complying with health and safety regulations. The plastic is injected in a liquid state (approx 180 °C) into the mold. In this fashion the plastic solidifies around the knife's tang forming a single block (blade-handle).

L'injection directe consiste à assembler la soie du couteau au plastique du manche, de sorte à obtenir un ensemble solide, robuste et inséparable. Il n'y a pas de creux susceptibles de laisser pénétrer l'eau ou les restes d'aliments ; c'est donc un processus complètement hygiénique, conforme aux exigences de santé et sécurité. Le plastique à l'état liquide (180 °C environ) est introduit dans un moule. Le plastique est solidifié autour de la soie du couteau, de sorte à former un seul bloc (lame-manche).

L'iniezione diretta consiste nell'unione del codolo del coltello con la plastica del manico, ottenendo un insieme solido, robusto e indivisibile. Non ci sono vuoti in cui possano entrare acqua o resti di alimenti, perciò è un processo completamente igienico, che rispetta le normative di sanità e sicurezza. Si inietta la plastica allo stato liquido (180°C circa) nello stampo. In questo modo la plastica si solidifica attorno al codolo del coltello, formando un blocco unico (lama-manico).

A injeção direta consiste em unir a espiga da faca com o plástico do cabo, criando assim um cabo sólido, robusto e inseparável. Não há buracos através dos quais possam entrar restos de água ou alimentos, pelo que é um processo totalmente higiénico, cumprindo os regulamentos de saúde e segurança. O plástico é injetado no molde em estado líquido (aprox. 180oC). O plástico solidifica em torno da espiga da faca, formando um único bloco (cabo-lâmina).

DOBLE INYECCIÓN

DOUBLE INJECTION · DOUBLE INJECTION · DOPPIA
INIEZIONE · INJEÇÃO DUPLA

La doble inyección es un proceso especial para formar el mango de un cuchillo, donde utilizamos una máquina de inyección directa con dos husillos. Este sistema de doble inyectado nos permite usar dos plásticos diferentes en el mango. En Arcos hemos desarrollado dos series con esta técnica: Colour Prof y Dúo. En ambas series inyectamos en la parte interior POLIPROPILENO, material duro que otorga fuerza y seguridad en la unión de mango-hoja; y CAUCHO en la parte exterior, material blando y no higroscópico (no absorbe líquidos), que otorga al cuchillo un tacto suave y una forma ergonómica, para que se adapte a la mano y sea cómodo para un uso prolongado.

Double injection is a special process that shapes the knife handle, where we use a direct injection moulding machine with two spindles. This double injection system enables us to use two different plastic materials for the handle. Arcos has developed two series with this technique: Colour Prof and Duo. In both series POLYPROPYLENE, a hard material that strengthens the joint between the blade and the handle, as well as making it safer, is injected into the interior of the handle and RUBBER, a material which is soft and non-hygroscopic (it does not absorb liquid), is moulded onto the exterior. This provides the knife with a soft feel and an ergonomic shape, so it can adapt to the hand and feel comfortable for prolonged use.

La double injection est un processus spécial employé dans la formation du manche du couteau, dans lequel on utilise une machine à injection directe avec deux broches. Ce système de double injection permet d'utiliser deux plastiques différents pour le manche. Au sein d'Arcos, nous avons mis au point deux gammes fondées sur cette technique : Colour Prof et Dúo. Dans les deux gammes, pour la partie intérieure, on injecte du POLYPROPYLENE, un matériau dur qui donne de la force et de la sécurité au niveau [11:09 AM] Teresa Sanchez

au niveau de la jointure entre le manche et la lame ; et pour la partie extérieure, du CAOUTCHOUC, un matériau flexible et hygroscopique (qui n'absorbe pas les liquides), rendant le couteau doux au toucher et lui dotant d'une forme ergonomique, qui s'adapte à la main et garantit le confort en cas d'utilisation prolongée.

La doppia iniezione è un processo speciale che serve per dare la forma al manico del coltello, in cui viene utilizzata una macchina per l'iniezione diretta con due mandrini. Questo sistema a doppia iniezione ci permette di utilizzare due diversi tipi di plastica. Ad Arcos abbiamo creato due serie utilizzando questa tecnica: Colour Prof e Duo. In entrambe le serie iniettiamo POLIPROPILENE nella parte interna, un materiale duro che garantisce l'unione solida e sicura tra il manico e la lama. Inoltre nella parte esterna si inietta GOMMA, un materiale morbido e igroscopico (non assorbe liquidi), che conferisce al coltello una forma ergonomica e una sensazione piacevole al tatto, per permettere una buona adattabilità alla mano e assicurare maggiore comodità anche in caso di uso prolungato.

A moldagem por injeção dupla é um processo especial para formar o cabo de uma faca, onde utilizamos uma máquina de injeção direta com dois fusos. Este sistema de dupla injeção permite-nos utilizar dois plásticos diferentes no cabo. Na Arcos desenvolvemos duas séries com esta técnica: Colour Prof e Duo. Em ambas as séries injetamos POLIPROPILENO no interior, um material duro que proporciona resistência e segurança na articulação cabo-lâmina; e BORRACHA no exterior, um material macio, não higroscópico (não absorve líquidos), que dá à faca um toque macio e uma forma ergonómica, para que se adapte à mão e seja confortável para uso prolongado.



NITRUM®

NITRUM® es la fórmula de acero al nitrógeno, ecológica y disponible solamente en los cuchillos ARCOS. NITRUM® proporciona más dureza¹, mayor poder de corte² y mejora la durabilidad del filo³. Su nueva microestructura marca la diferencia en el rendimiento de los cuchillos, tanto para un uso profesional como doméstico. El proceso de producción de NITRUM® respeta el medioambiente. El nitrógeno se encuentra en la atmósfera, y su proceso de enriquecimiento no tiene efectos negativos en el aire, agua o tierra.

NITRUM® is a Nitrogen enriched, eco-friendly stainless steel formula, available exclusively on ARCOS knives. With its improved hardness¹, enhanced cutting power², improved edge durability³, and improved Microstructure, NITRUM® can make the difference in the performance of knives for both professional and non-professional users. The NITRUM® production process is friendly with the environment. Nitrogen is readily available in the atmosphere, and its stainless steel enrichment process has no negative effect on the air, water or soil.

NITRUM® est la formule d'acier enrichi au nitrogène, écologique et disponible seulement dans les couteaux ARCOS. NITRUM® confère plus de dureté¹, un plus grand pouvoir de coupe² et une meilleure durabilité du fil³. Sa nouvelle microstructure marque la différence en terme de rendement

des couteaux destinés à être utilisés tant dans le cadre professionnel que domestique. Le procédé de production du NITRUM® respecte l'environnement. L'azote est présent dans l'atmosphère, et son procédé d'enrichissement n'a aucun impact sur l'air, l'eau ou la terre.

NITRUM® è la formula di acciaio al nitrogeno, ecologica ed disponibile soltanto nei coltelli ARCOS. NITRUM® Produce piu' durezza¹ maggior potere di taglio² e migliora la durabilità nel tempo del filo³. La sua nuova microstruttura marca la differenza nel rendimento dei coltelli, sia nell'utilizzo professionale che casalingo. Il processo di produzione del NITRUM® è ecocompatibile. Il nitrogeno è presente nella atmosfera ed il suo processo di arricchimento non produce effetti negativi nell'aria, nell'acqua e nella terra.

NITRUM® é a fórmula de aço de nitrogénio amigo do ambiente disponível apenas em facas ARCOS. NITRUM® proporciona maior dureza¹, maior poder de corte² e maior durabilidade da lâmina³. A sua nova microestrutura faz a diferença no desempenho das facas tanto para uso profissional como doméstico. O processo de produção do NITRUM® é amigo do ambiente. O nitrogénio encontra-se na atmosfera, e o seu processo de enriquecimento não tem efeitos negativos no ar, água ou solo.

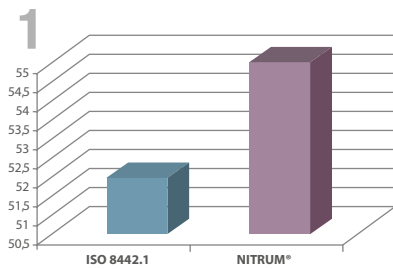

TEST DE DUREZA	ISO 8442.1
HARDNESS TEST	ISO 8442.1
TEST DE DURETÉ	ISO 8442.1
TEST DI DUREZZA	ISO 8442.1
ИСПЫТАНИЕ НА ТВЕРДОСТЬ	ISO 8442.1

¹ Mejora la Dureza:

NITRUM® sobrepasa la norma ISO 8442-1 en más de 3 HRC.

¹ Improved Hardness:

NITRUM® exceeds the ISO 8442-1 norm by more than 3 HRC.

¹ Améliore la dureté:

NITRUM® surpasse la norme ISO 8442-1 de plus de 3 HRC (dureté Rockwell).

¹ Migliora la Durezza:

NITRUM® supera la norma 8442.1 di oltre 3 HRC.

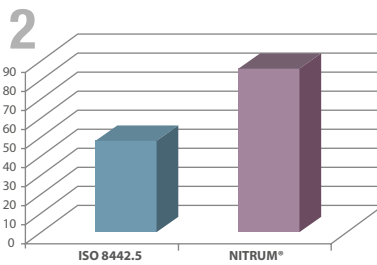

PODER DE CORTE INICIAL	ISO 8442.5
INITIAL CUTTING POWER I	ISO 8442.5
POUVOIR DE COUPE INITIAL CONFORME	ISO 8442.5
TEST DI DUREZZA	ISO 8442.5
НАЧАЛЬНАЯ РЕЖУЩАЯ СПОСОБНОСТЬ	ISO 8442.5

² Mayor Poder de Corte Inicial:

NITRUM® supera la norma ISO 8442-5 en más de un 70%.

² Enhanced Initial Cutting Power:

NITRUM® tested 70% higher than the ISO 8442-5 norm.

² Pouvoir de coupe initial supérieur:

NITRUM® surpasse la norme ISO 8442-5 de plus de 70 %.

² Maggior Potere di Taglio Iniziale:

NITRUM® supera la norma ISO 8442.5 di oltre il 70%.

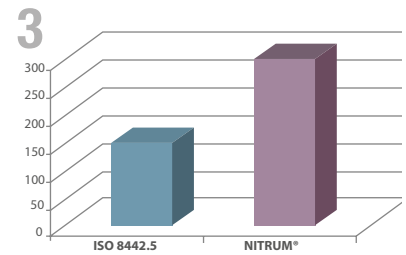

DURABILIDAD DEL FILO	ISO 8442.5
CUTTING EDGE RETENTION (EDGE DURABILITY)	ISO 8442.5
TEST DE DURETÉ ISO	ISO 8442.5
TEST DI DUREZZA ISO	ISO 8442.5
ИСПЫТАНИЕ НА ТВЕРДОСТЬ ISO	ISO 8442.5

³ Durabilidad:

NITRUM® supera en más de un 200% la norma ISO 8442-5.

³ Edge Durability:

NITRUM® tested 200% higher than the ISO 8442-5 norm.

³ Durabilità :

NITRUM® surpasse la norme ISO 8442-5 de plus de 200 %.

³ Durabilità:

NITRUM® supera di oltre il 200% la norma ISO 8442.5.



Alta tecnología para una completa protección bacteriostática en nuestros cuchillos.

Se trata de la integración en su mango de una sofisticada tecnología con base de plata, Bactiproof Silver, para detener la proliferación de bacterias y proporcionar un extra de higiene y seguridad.

Este sistema actúa como un potente inhibidor de bacterias, gérmenes, mohos y hongos. De este modo, el mango del cuchillo cuenta con los agentes necesarios para proteger el plástico de la aparición de manchas, olores y de microorganismos perjudiciales para la salud. En definitiva, actúa como el complemento perfecto para la cocina, un ambiente donde la higiene es fundamental. Bactiproof Silver reduce en un 99,9% la presencia de bacterias, hongos y moho en la superficie del mango. Además, su rendimiento antimicrobiano permanece constante durante toda la vida útil del cuchillo.

High technology for the complete bacteriostatic protection of our knives. The integration of silver based sophisticated technology Bactiproof Silver into the handles of these knives prevents the spread of bacteria and provides additional hygiene and safety.

This system acts as a powerful inhibitor against bacteria, germs, mould and fungi. The knife handle now has the necessary agents to protect the plastic against the appearance of stains, smells and microorganisms which are harmful to the health. In short, it is the perfect complement for the kitchen, an environment where hygiene is essential. Bactiproof Silver reduces the presence of bacteria, fungi and mould by 99.9% on the surface of the handle. Moreover, its antimicrobial performance remains constant throughout the useful lifetime of the knife.

Haute technologie pour une protection bactériostatique totale de nos couteaux.

Il s'agit de l'intégration, au niveau du manche, d'une technologie sophistiquée à base d'argent, Bactiproof Silver, capable de freiner la prolifération de bactéries et offrant davantage d'hygiène et de sécurité.

Ce système est un puissant inhibiteur de bactéries, de germes, de moisissures et de champignons. Ainsi, le manche du couteau est doté des agents nécessaires à la protection du plastique contre l'apparition de taches, d'odeurs et de microorganismes nocifs pour la santé. En somme, c'est le complément idéal pour la cuisine, un milieu où l'hygiène est essentielle. Bactiproof Silver réduit de 99,9 % la présence de bactéries, de champignons et de moisissures sur la surface du manche. De plus, ses propriétés anti-microbes restent constantes pendant toute la durée de vie du couteau.

Alta tecnologia per una protezione batteriostatica totale dei nostri coltelli. L'inserimento nella composizione del manico di una sofisticata tecnologia a base d'argento, la Bactiproof Silver, per impedire la proliferazione di batteri e garantire prestazioni eccellenti in quanto a igiene e sicurezza. Questo sistema funziona come un potente inibitore di batteri, germi, muffe e funghi. Di conseguenza, il manico del coltello dispone degli strumenti necessari per proteggere la plastica dall'apparizione di macchie, cattivi odori e microrganismi dannosi per la salute. In poche parole, è l'alleato perfetto per la tua cucina, un ambiente in cui l'igiene è fondamentale. Bactiproof Silver riduce del 99,9% la presenza di batteri, funghi e muffe sulla superficie del manico. Inoltre la sua capacità di impedire la proliferazione dei microbi si mantiene inalterata per tutta la vita del coltello.

Alta tecnologia para uma proteção bacteriostática completa nas nossas facas.

Refere-se à integração em seu cabo de uma sofisticada tecnologia à base de prata, Bactiproof Silver, para impedir a proliferação de bactérias e proporcionar uma higiene e segurança extra.

Este sistema atua como um poderoso inibidor de bactérias, germes, mofo e fungos. Dessa forma, o cabo da faca conta com os agentes necessários para proteger o plástico do aparecimento de manchas, odores e de microorganismos prejudiciais à saúde.

Em suma, atua como o complemento perfeito para a cozinha, um ambiente onde a higiene é fundamental. Bactiproof Silver reduz em 99,9% a presença de bactérias, fungos e mofo na superfície do cabo. Além disso, seu desempenho antimicrobiano permanece constante durante toda a vida útil da faca.



ICE PLUS

TRATAMIENTO TÉRMICO SUB-CERO "ICE-PLUS"

El tratamiento térmico sub-cero "Ice-Plus", aplicado en la serie Colour-Prof, consiste en un enfriamiento a -80°C, tras realizar el tradicional temple, con el objetivo de mejorar la estructura del acero inoxidable, eliminando el pequeño porcentaje de austenita residual. La estructura de acero que se obtiene otorga propiedades especiales al cuchillo, tanto de resistencia al impacto como al desgaste.

"ICE-PLUS" SUB-ZERO HEAT TREATMENT

The "Ice-Plus" sub-zero heat treatment applied to the Colour-Prof series consists in cooling material to -80°C, after the traditional tempering has been carried out, with the aim of improving the structure of the stainless steel, eliminating the small percentage of residual austenite. The structure of the steel that is obtained provides the knives with special properties which makes them resistant to both impact and wear.

TRAITEMENT THERMIQUE SUB-ZÉRO "ICE-PLUS"

Le traitement thermique sub-zéro "Ice-Plus" appliqué à la gamme Colour-Prof consiste dans un refroidissement à -80°C après la réalisation de la trempe traditionnelle, afin d'améliorer la structure de l'acier inoxydable, moyennant l'élimination du bas pourcentage d'austénite résiduelle. La structure en acier obtenue dote le couteau de certaines propriétés spéciales, aussi bien en termes de résistance aux chocs que d'usure.

TRATTAMENTO TERMICO SOTTOZERO "ICE-PLUS"

Il trattamento termico sottozero "Ice-Plus", che viene applicato alla serie Colour-Prof, consiste nel raffreddamento dell'acciaio inox a -80°C al fine di migliorarne la struttura, eliminando la scarsa percentuale di austenite residua al termine del processo di tempra.

La risultante struttura in acciaio conferisce al coltello speciali proprietà di resistenza, sia all'impatto che all'usura.

O tratamento térmico sub-zero "Ice-Plus", aplicado na série Colour-Prof, consiste num arrefecimento a -80°C, após realizar o tradicional endurecimento, com o objetivo de melhorar a estrutura do aço inoxidável, eliminando a pequena percentagem de austenite residual. A estrutura de aço obtida confere propriedades especiais à faca, tanto de resistência ao impacto como ao desgaste.

REMACHES

STAINLESS STEEL RIVETS · RIVETS INOX · RIVETTI IN ACCIAIO INOSSIDABILE · REBITES

El compromiso de mejora continua, que caracteriza a ARCOS desde su fundación, ha permitido la innovación constante de sus productos. Una de las mejoras ha consistido en la utilización de remaches de Acero Inoxidable, en lugar de los remaches de aluminio, utilizados hasta ahora. Estos nuevos remaches, además de mejorar el montaje de los mangos, gracias a una mayor fuerza de sujeción, aumentan extraordinariamente la resistencia a la corrosión, garantizando que nunca se suelten los mangos de los cuchillos por este fenómeno.

A commitment for continuous improvement, one of the main features of ARCOS from its foundation, has allowed the constant innovation of our products; being our achievement the use of Stainless Steel rivets, instead of aluminium rivets, as usual till now. These new rivets, apart from improving the assembly of handles thanks to a major subsection strength, increase extraordinarily their resistance to corrosion, guaranteeing that handles never come loose from the knives due to this reason.

La politique en matière d'innovation qui caractérise ARCOS a contribué de manière continue à l'amélioration de ses produits. La amélioration a consisté à préférer les rivets en acier inoxydable aux rivets en aluminium utilisés jusqu'alors. Ces nouveaux rivets, non seulement améliorent le montage des manches grâce à une meilleure force de serrage, mais augmentent également sensiblement la résistance à la corrosion ; les manches des couteaux ne risquent donc pas de présenter du jeu ou de se désolidariser de leur support sous l'effet de ce phénomène.

La ricerca per migliorare continuamente, che caratterizza ARCOS sin dal momento della sua fondazione, ha ottenuto il risultato di una innovazione continua dei suoi prodotti. La miglioramento ottenuto, è stato l'inserimento di rivetti in acciaio inossidabile, sostituendo quelli in alluminio precedentemente utilizzati. Questi nuovi rivetti, oltre a migliorare e facilitare il montaggio dei manici, grazie ad una maggiore forza di assoggettamento, aumentano enormemente la resistenza alla corrosione, non permettendo mai il distacco del manico dalla lama, effetto questo dovuto principalmente alla corrosione stessa.

O compromisso com a melhoria contínua, que caracteriza a ARCOS desde a sua fundação, permitiu a inovação constante dos seus produtos. Uma das melhorias foi a utilização de rebites de Aço Inoxidável, em vez dos rebites de alumínio. Esses novos rebites, além de melhorar a montagem dos cabos, graças a uma maior força de sujeição, aumentam extraordinariamente a resistência à corrosão, garantindo que os cabos das facas nunca se soltam por este fenómeno.



FILO SEDA

SILK EDGE · SILK EDGE · FILO SETA · FIO SEDA

El Filo Seda ha sido creado aunando los conocimientos de nuestros maestros cuchilleros con la tecnología más innovadora, obteniendo así un corte único, con un acabado pulido y característico a lo largo del filo.

El proceso de realización se divide en tres fases de afilado y pulido, realizadas manualmente y que dan como resultado un corte suave y preciso, que no deja indiferente a quien lo usa. Tradición y tecnología unidas para crear nuestro filo especial Seda, que se implementó por primera vez en nuestra serie Manhattan, incorporándose actualmente a las series Brooklyn y Ópera.

The Silken Edge has been created by pooling the expertise of our cutlery and technology at the forefront of innovation, thereby obtaining a unique cut, with a polished and characteristic finish along the edge. The manufacturing process is divided into three sharpening and polishing stages, performed manually and resulting in a smooth and precise cut, which amazes everybody who uses the knife. Tradition and technology combined to create our special Silken edge, which was first implemented in our Manhattan series, currently added to the Brooklyn and Ópera series.

Le Tranchant silk edge a été créé grâce à la combinaison des connaissances de nos maîtres couteliers et la technologie la plus

innovante, ce qui a permis d'obtenir une découpe unique, avec une finition polie et caractéristique tout au long du tranchant. Le processus de réalisation se compose de trois étapes d'affûtage et de polissage, réalisées à la main et dont le résultat est une découpe douce et précise, qui ne laisse indifférent aucun utilisateur. Tradition et technologie se donnent la main pour créer notre tranchant spécial silk edge, qui a été mis en œuvre pour la première fois dans notre série Manhattan, et qui est actuellement appliqué dans les séries Brooklyn et Ópera.

Il Filo Seta è stato creato integrando le conoscenze dei nostri maestri coltellinai e le tecnologie più innovatrici, per ottenere in questo modo un taglio unico, con una finitura netta e caratteristica lungo tutto il filo. Il processo di produzione si divide in tre fasi di affilatura e lucidatura, effettuate a mano, e il cui risultato è un taglio morbido e preciso, che non lascia indifferente chi lo usa. Tradizione e tecnologia si compenetrano per creare il nostro speciale filo Seta, implementato per la prima volta nella nostra serie Manhattan e che ora si incorpora alle serie Brooklyn e Ópera.

O Fio Seda foi criado combinando os conhecimentos dos nossos mestres couteleiros com a tecnologia mais inovadora, obtendo assim um corte único, com um acabamento polido e característico ao longo da lâmina. O processo de fabrico é dividido em três fases de afiação e polimento, realizadas manualmente e que resultam em um corte suave e preciso, que não deixa indiferente quem o utiliza.

Tradição e tecnologia unidas para criar nosso especial fio Seda, que foi implementado pela primeira vez na nossa série Manhattan, incorporando-se atualmente às séries Brooklyn, Nórdika e Ópera.

NOVELTIES
NOUVEAUTÉS
NOVITÀ
NOVIDADES

NOVEDADES



SERIE LÍNEA

ARCOS®



99

REF: 379300	LÍNEA	100mm/3,9" 228mm/8,9"
-------------	-------	--------------------------

Mondador // Paring Knife // C. Office // Spelucchino
Descascador



99

REF: 379400	LÍNEA	140mm/5,5" 299mm/11,7"
-------------	-------	---------------------------

Cocina // Kitchen Knife // Couteau Cuisine // Coltello Cucina
Cozinha



99

REF: 379500	LÍNEA	180mm/7" 343mm/13,5"
-------------	-------	-------------------------

Cocina // Kitchen Knife // Couteau Cuisine // Coltello Cucina
Cozinha



100

REF: 373424	LÍNEA	150mm/5,9" 265mm/10,4"
-------------	-------	---------------------------

Cuchillo Mesa (Microperlado) // Table Knife (Micro-Pearl)
Couteau Table (Microperlé) // Coltello Tavola (Microperlato)
Faca Mesa (Microperolado)



373624



100

REF: 849300	LÍNEA
-------------	-------

Set 2 piezas // 2 pc. Set // Set 2 Ctx. // Set 2 Pezzi
Conjunto 2 Peças

SERIE NÓRDIKA

ARCOS®



54

REF: 165300	NÓRDIKA	170mm/6,6" 340mm/13,3"
-------------	---------	---------------------------

Tenedor Trinchante // Carving Fork // Fourchette Diapason
Forchettone // Garfo Trinchante



54

REF: 165500	NÓRDIKA	200mm/8" 340mm/13,3"
-------------	---------	-------------------------

Cuchillo Trinchante // Carving knife // Couteau à Découper
Coltello Trinciante // Faca de Trinchar



4 X 1649

57

REF: 167400

NÓRDIKA

Set 4 piezas // 4 pc. Set // Set 4 Ctx. // Set 4 Pezzi
Conjunto 4 Peças

SERIE FOREST



162

REF: 374200	FOREST	126mm/4,9" 257mm/10,1"
-------------	--------	---------------------------

Cuchillo para Churrasco (Perlado) // Steak Knife (Serrated)
C. Steak Churrasco (Cranté) // Coltello Bistecca (Seghettato)
Faca para Churrasco (Perolado)

SERIE FOREST



161

REF: 371600	FOREST	100mm/3,9" 208mm/8,1"
-------------	--------	--------------------------

Tenedor // Steak Fork // Fourchette Table // Forchetta Bistecca // Garfo Mesa



159

REF: 371900	FOREST	100mm/3,9" 208mm/8,1"
-------------	--------	--------------------------

Tenedor // Steak Fork // Fourchette Table // Forchetta Bistecca // Garfo Mesa



161

REF: 371700	FOREST	100mm/3,9" 206mm/8,1"
-------------	--------	--------------------------

Cuchara Mesa // Table Spoon // Cuillère Table // Cucchiaine Tavola // Colher Mesa



159

REF: 372100	FOREST	100mm/3,9" 206mm/8,1"
-------------	--------	--------------------------

Cuchara Mesa // Table Spoon // Cuillère Table // Cucchiaine Tavola // Colher Mesa



161

REF: 371400	FOREST	75mm/2,9" 155mm/6,1"
-------------	--------	-------------------------

Cuchara Lunch // Lunch Spoon // Cuillère Lunch // Cucchiaio Frutta Colher Lunch



159

REF: 373000	FOREST	75mm/2,9" 155mm/6,1"
-------------	--------	-------------------------

Cuchara Lunch // Lunch Spoon // Cuillère Lunch // Cucchiaio Colher Lunch

SERIE RIVIERA

ARCOS®



230200
233400
233100

63

REF: 834200

RIVIERA

Set 3 piezas // 3 pc. Set // Set 3 Ctx. // Set 3 Pezzi
Conjunto 3 Peças

SERIE MANHATTAN



1616
1620
1601

44

REF: 163200

MANHATTAN

Set 3 piezas // 3 pc. Set // Set 3 Ctx. // Set 3 Pezzi
Conjunto 3 Peças

SERIE STEEL FORCE



4 X 376900

155

REF: 377900

STEEL-FORCE

Set Chuleteros 4 piezas // 4 pc. Steak Set // Set 4 Steak
Bois Set Steak 4 // Pezzi Conjunto 4 Peças

SERIE NOVA

ARCOS®



2 X 188600

110

REF: 187000

NOVA

Set 2 piezas // 2 pc. Set // Set 2 Ctx. // Set 2 Pezzi
Conjunto 2 Peças



2 X 188500

110

REF: 189800

NOVA

Set 2 piezas // 2 pc. Set // Set 2 Ctx. // Set 2 Pezzi
Conjunto 2 Peças



2 X 188800

110

REF: 189900

NOVA

Set 2 piezas // 2 pc. Set // Set 2 Ctx. // Set 2 Pezzi
Conjunto 2 Peças

SERIE MANCHEGA

ARCOS®



189 REF: 479400 MANCHEGA 225mm/8,8"
120mm/4,7"
Cuchillo Mesa (Perlado) // Table Knife (Serrated) // Couteau
Table (Cranté) // Coltello Tavola (Seghettato) // Faca Mesa
(Perolado)



189 REF: 479200 MANCHEGA 78mm/3"
171mm/6,7"
Cuchara Postre // Dessert Spoon // Cuillère Dessert
Cucchiaio Frutta // Colher Sobremesa







189 REF: 479500 MANCHEGA 100mm/3,9"
205mm/8,7"
Cuchara Mesa // Table Spoon // Cuillère Table // Cucchiaio
Tavola Colher Mesa



189 REF: 479600 MANCHEGA 100mm/3,9"
205mm/8,7"
Tenedor Mesa // Table Fork // Fourchette Table // Forchetta
Tavola // Garfo Mesa



190 REF: 480100 MANCHEGA
Estuche 16 Piezas // 16 Pc. Set // Ménagère 16 Pièces
Confezione 16 Pezzi // Conjunto 16 Peças

	4 X 479400	16
	4 X 479500	
	4 X 479600	
	4 X 479200	

SARTENES Y CACEROLAS

ARCOS®



252

REF: 697900	THERA	X4
-------------	-------	----

Batería de Cocina // Cookware set // Batterie de Cuisine
Batteria da Cucina // Conjunto de Panelas



244

REF: 697500	SAMOA	X5
-------------	-------	----

Batería de Cocina // Cookware set // Batterie de Cuisine
Batteria da Cucina // Conjunto de Panelas



259

REF: 697400	KAULA	X5
-------------	-------	----

Batería de Cocina // Cookware set // Batterie de Cuisine
Batteria da Cucina // Conjunto de Panelas

CHAIRAS



● 279623

285

REF: 279600	CHAIRAS	300mm/11,8" 440mm/17,3"
-------------	---------	----------------------------

Chaira de Grano Extra Fino Ovalada // Extra Fine Grain Oval Honing Steel // Fusil Mèche Ovale Taillage Extra Fin Affilatoio ovale a Grana Super Fine // Afiador de Grão Extra Fino Oval



● 279923

285

REF: 279900	CHAIRAS	350mm/13,7" 490mm/19,3"
-------------	---------	----------------------------

Chaira de Grano Extra Fino Ovalada // Extra Fine Grain Oval Honing Steel // Fusil Grain Extra Fin Ovale // Affilatoio ovale a Grana Super Fine // Afiador de Grão Extra Fino Oval

SERIE PROCHEF



226

REF: 185610	PROCHEF	215mm/8,4"
-------------	---------	------------

Tijeras Cocina // Kitchen Scissors Ciseaux // Cuisine tForbici Cucina // Tesouras Cozinha

ÚTILES Y GADGETS



272

REF: 607420	ÚTILES	43,7mm/1,7" 130mm/5"
-------------	--------	-------------------------

Pelador Tomate // Tomato Peeler // Éplucheur Tomate Pelapomodoro // Descascador Tomate



272

REF: 607300	ÚTILES	43,7mm/1,7" 130mm/5"
-------------	--------	-------------------------

Pelador // Peeler // Éplucheur // Pelapatate // Descascador

UTENSILIOS DE COCINA



275 REF: 685000 | UTENSILIOS | 331mm/13"
Espátula // Spatula // Spatule // Spatola // Espátula



277 REF: 685600 | UTENSILIOS | 260mm/10,2"
Pinzas de Cocina // Kitchen tongs // Pinze da Cucina
Pince de Cuisine // Pinças de Cozinha



275 REF: 685100 | UTENSILIOS | 330mm/12,9"
Cuchara // Spoon // Cuillère // Cucchiaino // Colher



275 REF: 685200 | UTENSILIOS | 337mm/13,2"
Cuchara Pasta // Pasta Server // Cuillère à Spaghetti
Cucchiaino di Pasta // Colher Para Massa



275 REF: 685400 | UTENSILIOS | 323mm/12,7"
Cazo // Ladle // Louche // Mestolo // Concha



275 REF: 685300 | UTENSILIOS | 339mm/13,3"
Espátula Ranurada // Slotted Turner // Spatule Ajourée
Spatola Scanalata // Espátula con Fessure



275 REF: 685500 | UTENSILIOS | 350mm/13,7"
Espumadera // Skimmer // Écuimoire // Schiumarola
Espumadeira

KNIVES
COUTEAUX
COLTELLI
FACAS



CUCHILLOS

BROOKLYN
PÁG 34-39



CLARA
PÁG 70-74



NOVA
PÁG 104-110



MANHATTAN
PÁG 40-45



UNIVERSAL HOME
PÁG 75-88



KIDS
PÁG 111



ÓPERA
PÁG 46-51



MAITRE
PÁG 89-93



ATLÁNTICO
PÁG 112-114



NÓRDIKA
PÁG 52-57



NIZA
PÁG 94-97



UNIVERSAL PRO
PÁG 115-119



RIVIERA
PÁG 58-63



LÍNEA
PÁG 98-100



COLOUR PROF
PÁG 120-127



RIVIERA BLANC
PÁG 64-69



LATINA
PÁG 101-103



2900
PÁG 128-143





SERIE BROOKLYN

Brooklyn es toda una invitación a cocinar, descubrir y, por supuesto, compartir. La textura de su mango de Micarta llevará el azul del Mediterráneo a tu cocina.

Brooklyn is a real invitation to cook, discover and, of course, share. The texture of its Micarta handle will bring the blue of the Mediterranean to your kitchen.

Brooklyn est une véritable invitation à cuisiner, à découvrir et, bien sûr, à partager. La texture de son manche en Micarta apportera le bleu de la Méditerranée à votre cuisine.

Brooklyn costituisce un vero invito a cucinare, scoprire e, ovviamente, condividere. La consistenza del suo manico di Micarta porterà l'azzurro del Mediterraneo nella vostra cucina.

Brooklyn é um convite para cozinhar, descobrir e, claro, partilhar. A textura do seu cabo em Micarta trará o azul do Mediterrâneo para a sua cozinha.

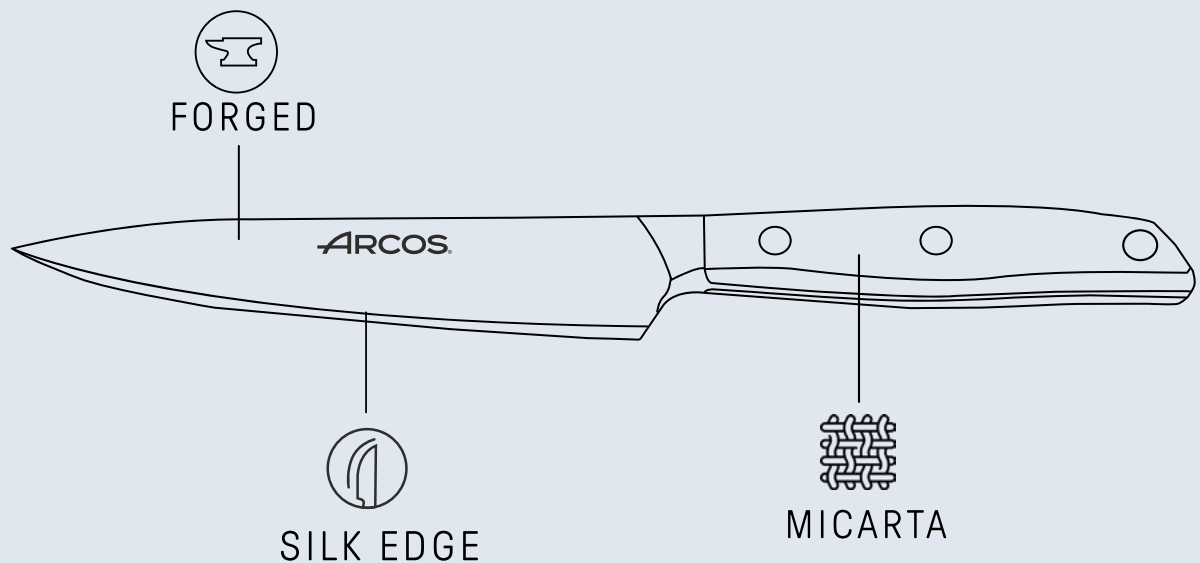

Forjado

Forged · Forgé · Forgiato · Forjado.

Acero Inoxidable Forjado NITRUM®

NITRUM® Forged Stainless Steel · Acier Inoxydable Forgé NITRUM® · Acciaio Inossidabile Forgiato NITRUM® · Aço Inoxidável Forjado NITRUM®.

Media Virola

Curved Bolster · Mitre Biseautée · Mezzo Nodo Forgiato Meia Virola.

Filo Seda

Silk Edge · Silk Edge · Filo Seta · Fio Seda.

Recazo redondeado

Rounded Back · Dos de Lame Adouci · Costola Arrotondata Dorso Arredondado.

Micarta

Micarta Handle · Manche en MICARTA · Manico di MICARTA Punho MICARTA.

Remaches de Acero Inox

Stainless Steel Rivets · Rivets en Acier Inoxydables · Rivetti in Acciaio Inossidabile · Rebites de Aço Inoxidável.

	Estuche	Case	Étui	Astuccio	Estojo
	Acero Inoxidable Forjado NITRUM® MICARTA	NITRUM® Forged Stainless Steel MICARTA	Acier Inoxydable Forgé NITRUM® MICARTA	Acciaio Inossidabile Forgiato NITRUM® MICARTA	Aço Inoxidável Forjado NITRUM® MICARTA



190123

 100mm/4"
209mm/8,2"

Mondador // Paring Knife
C. Office // Spelucchino
Descascador



191123

 130mm/5"
240mm/9,4"

Verduras // Vegetable Knife
C. Office // Coltello Verdura
Legumes



190423

 150mm/6"
273mm/10,7"

Cocinero // Chef's Knife
C. Cuisine // Coltello Cucina
Cozinheiro



190623

 210mm/8"
353mm/13,8"

Cocinero // Chef's Knife
C. Cuisine // Coltello Cucina
Cozinheiro



190823

 250mm/10"
393mm/15,4"

Cocinero // Chef's Knife
C. Cuisine // Coltello Cucina
Cozinheiro

	Estuche	Case	Étui	Astuccio	Estojo
	Acero Inoxidable forjado NITRUM® MICARTA	NITRUM® Forged Stainless Steel MICARTA	Acier Inoxydable Forgé NITRUM® MICARTA	Acciaio Inossidabile Forgiato NITRUM® MICARTA	Aço Inoxidável Forjado NITRUM® MICARTA



192023



Tomatero (Perlado) // Tomato Knife (Serrated) // C. Citron Tomate (Cranté) // Coltello Pomodoro (Seghettato) // Para Tomate (Perolado)



192623



Deshuesador // Boning Knife C. À Désosser // Coltello Disosso Para Desossar



191623

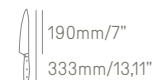

Rocking Santoku // Rocking Santoku Knife // C. Rocking Santoku // Coltello Rocking Santoku // Rocking Santoku



191323

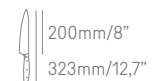

Panero // Bread Knife (Serrated) C. Pain (Cranté) // Coltello Pane (Seghettato) // Para Pão (Perolado)



191923

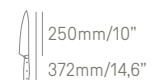

Jamoner // Slicing Knife (Flexible) C. Jambon (Flexible) // Coltello Prosciutto (Flessibile) // Para Presunto (Flexível)

	Estuche	Case	Étui	Astuccio	Estojo
	Acero Inoxidable forjado NITRUM® MICARTA	NITRUM® Forged Stainless Steel MICARTA	Acier Inoxydable Forgé NITRUM® MICARTA	Acciaio Inossidabile Forgiato NITRUM® MICARTA	Aço Inoxidável Forjado NITRUM® MICARTA



190123

190423

191623



858110

Set 3 piezas // 3 Pc. Set // Set 3 Ctx.
Set 3 Pezzi // Conjunto 3 Peças

	Caja Regalo	Gift Box	Boîte Cadeau	Scatola Regalo	Caixa de Presente
	Acero Inoxidable forjado Nitrum® MICARTA	NITRUM® Stainless Steel MICARTA	Acier Inoxydable NITRUM® MICARTA	Acciaio Inossidabile NITRUM® MICARTA	Aço Inoxidável NITRUM® MICARTA
	Madera de Caucho Lacada	Lacquered Rubber Wood	Bois de Caoutchouc Laqué	Legno di Caucciù Laccato	Madeira de Borracha Laqueada



784911

190123

190423

191623



194000

Juego 4 piezas // 4 pc. Set // Bloc 4
Pièces // Ceppo 4 Pezzi // Conjunto
4 Peças





SERIE MANHATTAN

Con la audacia y la imponente arquitectura neoyorquina como musa, la serie Manhattan destila estos elementos en cuchillos ideales para chefs que buscan perfección y precisión en cada plato. Un tributo a la cocina innovadora.

With the bold and impressive New York architecture as a muse, the Manhattan series displays these features in ideal knives for chefs who want perfection and precision in each dish. A tribute to innovative cooking.

Avec l'audace et l'imposante architecture new-yorkaise comme inspiration, la série Manhattan distille ces éléments dans des couteaux idéaux pour les chefs à la recherche de perfection et de précision dans chaque plat. Un hommage à la cuisine innovante.

Ispirata dalla musa dell'audacia e dell'imponente architettura newyorchese, la serie Manhattan distilla questi elementi in coltelli ideali per gli chef che aspirano alla perfezione e precisione in ogni piatto. Un tributo alla cucina innovatrice.

Com a audácia e a arquitetura imponente de Nova Iorque como musa, a série Manhattan destila estes elementos em facas ideais para chefs que procuram a perfeição e a precisão em cada prato. Uma homenagem à cozinha inovadora.

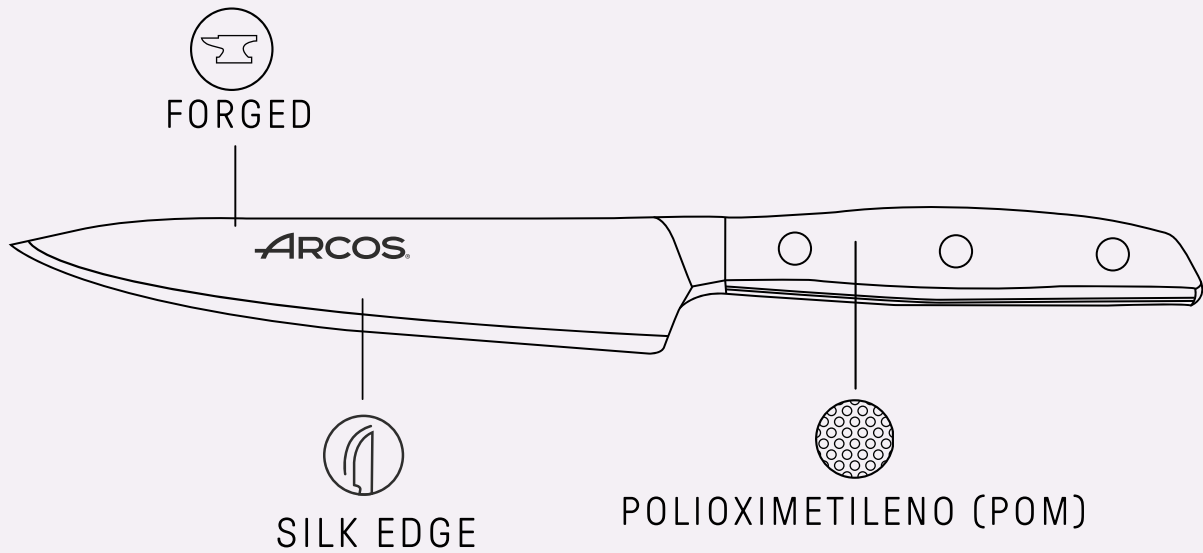

 **Forjado**

Forged · Forgé · Forgiato · Forjado.

Acero Inoxidable Forjado NITRUM®

NITRUM® Forged Stainless Steel · Acier Inoxydable Forgé NITRUM® · Acciaio Inossidabile Forgiato NITRUM® · Aço Inoxidável Forjado NITRUM®.

 **Recazo Redondeado**

Rounded Back · Dos de Lame Adouci · Costola Arrotondata · Dorso Arredondado.

 **Filo Seda**

Silk Edge · Silk Edge · Filo Seta · Fio Seda.

 **Plásticos Técnicos (POM)**



Technical Plastics (POM) · Plastiques Techniques (POM) · Plastiche Tecniche (POM) · Plásticos Técnicos (POM).

Media Virola

Curved Bolster · Mitre Biseauté · Mezzo Nodo Forgiato · Meia Virola.

 **National Sanitary Foundation**

 **Bactiproof Silver®**

	Estuche	Case	Étui	Astuccio	Estojo
	Acero Inoxidable Forjado NITRUM® Polioximetileno (POM)	NITRUM® Forged Stainless Steel Polyoxymethylene (POM)	Acier Inoxydable Forgé NITRUM® Polyoxyméthylène (POM)	Acciaio Inossidabile Forgiato NITRUM® Polioximetileno (POM)	Aço Inoxidável Forjado NITRUM® Polioximetileno (POM)



160100

 100mm/4"
210mm/8,2"

Mondador // Paring Knife
C. Office // Spelucchino
Descascador



161100

 130mm/5,1"
240mm/9,4"

Verduras // Vegetable Knife
C. Office // Coltello Verdura
Legumes



162000

 130mm/5"
240mm/9,4"

Tomatero (Perlado) // Tomato Knife
(Serrated) // C. Citron-Tomate
(Cranté) // Coltello Pomodoro
(Seghettato) // Para Tomate
(Perlado)



160400

 150mm/6"
273mm/10,7"

Cocinero // Chef's Knife
C. Cuisine // Coltello Cucina
Cozinheiro



160600

 210mm/8"
353mm/13,8"



Cocinero // Chef's Knife
C. Cuisine // Coltello Cucina
Cozinheiro



160800

 250mm/10"
393mm/15,4"

Cocinero // Chef's Knife
C. Cuisine // Coltello Cucina
Cozinheiro

	Estuche	Case	Étui	Astuccio	Estojo
	Acero Inoxidable Forjado NITRUM® Polioximetileno (POM)	NITRUM® Forged Stainless Steel Polyoxymethylene (POM)	Acier Inoxydable Forgé NITRUM® Polyoxyméthylène (POM)	Acciaio Inossidabile Forgiato NITRUM® Polioximetilene (POM)	Aço Inoxidável Forjado NITRUM® Polioximetileno (POM)



162600



Deshuesador // Boning Knife
C. À Désosser // Coltello Disosso
Para Desossar



161300



Panero // Bread Knife (Serrated)
C. Pain (Cranté) // Coltello Pane
(Seghettato) // Para Pão (Perolado)



161400



Lenguado (Flexible) // Sole Knife (Flexible) // C. Filet de Sole (Flexible) // Coltello Sogliola (Flessibile) // Linguado (Flexível)



161600

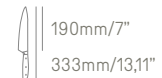

Rocking Santoku // Rocking Santoku Knife // C. Rocking Santoku // Coltello Rocking Santoku // Rocking Santoku



161900





Jamoner // Slicing Knife (Flexible) // C. Jambon (Flexible) // Coltello Prosciutto (Flessibile) // Para Presunto (Flexível)



162300



Jamoner // Slicing Knife (Flexible) // C. Jambon (Flexible) // Coltello Prosciutto (Flessibile) // Para Presunto (Flexível)

	Estuche	Case	Étui	Astuccio	Estojo
	Acero Inoxidable Forjado NITRUM® Polioximetileno (POM)	NITRUM® Forged Stainless Steel Polyoxymethylene (POM)	Acier Inoxydable Forgé NITRUM® Polyoxyméthylène (POM)	Acciaio Inossidabile Forgiato NITRUM® Polioximetilene (POM)	Aço Inoxidável Forjado NITRUM® Polioximetileno (POM)

858100

Set 3 piezas // 3 pc. Set // Set 3 Ctx.
Set 3 Pezzi // Conjunto 3 Peças



1601 1604 1616





163200

Set 3 piezas // 3 pc. Set // Set 3 Ctx.
Set 3 Pezzi // Conjunto 3 Peças



1601 1620 1616



	Estuche	Case	Étui	Astuccio	Estojo
	Acero Inoxidable Forjado NITRUM® Polioximetileno (POM)	NITRUM® Forged Stainless Steel Polyoxymethylene (POM)	Acier Inoxydable Forgé NITRUM® Polyoxyméthylène (POM)	Acciaio Inossidabile Forgiato NITRUM® Polioximetilene (POM)	Aço Inoxidável Forjado NITRUM® Polioximetileno (POM)
	Madera de Caucho	Rubber Wood	Bois de Caoutchouc	Legno di Caucciù	Madeira de Borracha



7849 1601 1604 1616



163300

Juego 4 piezas // 4 pc. Set // Bloc 4
Pièces // Ceppo 4 Pezzi // Conjunto
4 Peças



ARCOS
MADE IN ALBACETE SPAIN

NITRUM[®] Stainless Steel
1614 170mm (7")

NSF

023

COMBIPLATA



SERIE OPERA

La definición de precisión. Ópera ofrece un filo seda revolucionario para cortes excepcionalmente suaves y precisos. Un indispensable en la cocina del chef moderno que aprecia la fusión de artesanía y tecnología avanzada.

The definition of precision. Ópera has a revolutionary silk edge for exceptionally smooth and precise cuts. An absolute must in the kitchen of a modern chef who appreciates the blend of craftsmanship and advanced technology.

La quintessence de la précision. Ópera propose un fil de lame révolutionnaire Silk Edge, pour des coupes exceptionnellement faciles et précises. Un incontournable dans la cuisine du chef moderne qui apprécie la symbiose entre savoir-faire artisanal et technologie de pointe.

La definizione della precisione. Ópera offre un filo di seta rivoluzionario per tagli eccezionalmente morbidi e precisi. Un imprescindibile nella cucina dello chef moderno che apprezza la fusione di artigianato e tecnologia avanzata.

A definição de precisão. Opera oferece um revolucionário fio de seda para cortes exceccionalmente suaves e precisos. Uma peça indispensável na cozinha do cozinheiro moderno que aprecia a fusão de artesanato e tecnologia avançada.

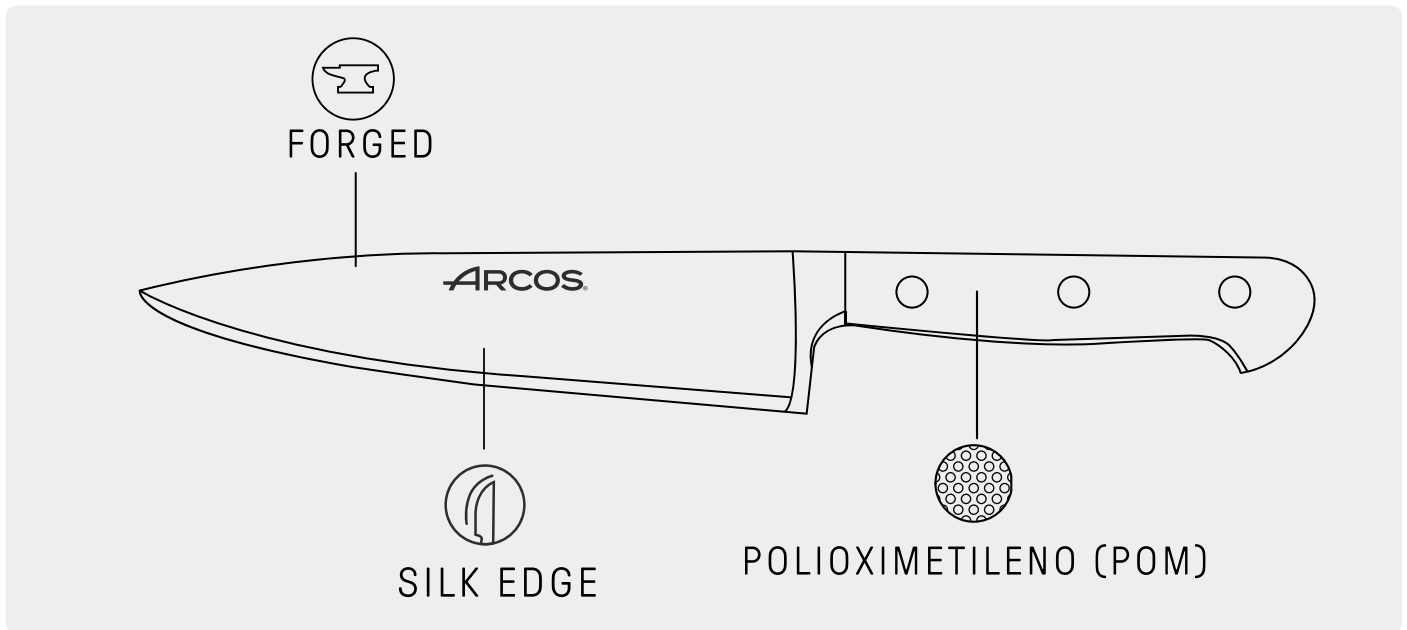

Forjado

Forged · Forgé · Forgiato · Forjado.

Acero Inoxidable Forjado NITRUM®

NITRUM® Forged Stainless Steel · Acier Inoxydable Forgé NITRUM® · Acciaio Inossidabile Forgiato NITRUM® · Aço Inoxidável Forjado NITRUM®.

Filo Seda

Silk Edge · Silk Edge · Filo Seta · Fio Seda.

Recazo redondeado

Rounded Back · Dos de Lame Adouci · Costola Arrotondata · Dorso Arredondado.



Plásticos Técnicos (POM)

Technical Plastics (POM) · Plastiques Techniques (POM) · Plastiche Tecniche (POM) · Plásticos Técnicos (POM).

Remaches de Acero Inox

Stainless Steel Rivets · Rivets en Acier Inoxydable · Rivetti in Acciaio Inossidabile · Rebites de Aço Inoxidável.

National Sanitary Foundation

	Estuche	Case	Étui	Astuccio	Estojo
	Acero Inoxidable forjado NITRUM® Polioximetileno (POM)	NITRUM® Forged Stainless Steel Polyoxymethylene (POM)	Acier Inoxydable Forgé NITRUM® Polyoxyméthylène (POM)	Acciaio Inossidabile Forgiato NITRUM® Polioximetilene (POM)	Aço Inoxidável Forjado NITRUM® Polioximetileno (POM)



225700

100mm/4"
214mm/8,4"

Mondador // Paring Knife
C. Office // Spelucchino
Descascador



225600

130mm/5"
234mm/9,2"

Tomatero (Perlado) // Tomato Knife
(Serrated) // C. Citron-Tomate
(Cranté) // Coltello Pomodoro
(Seghettato) // Para Tomate
(Perolado)



224900

140mm/5"
266mm/10,4"

Cocinero // Chef's Knife
C. Cuisine // Coltello Cucina
Cozinheiro



226900

140mm/5"
267mm/10,5"

Santoku (Con Alveolos)
Santoku Knife (Granton Edge)
C. Santoku (Alvéolé) // Coltello
Santoku (Con Alveole) // Santoku
(com Alveolos)



226600

180mm/7"
307mm/12"

Santoku (Con Alveolos)
Santoku Knife (Granton Edge)
C. Santoku (Alvéolé) // Coltello
Santoku (Con Alveole) // Santoku
(com Alveolos)



229900

180mm/7"
319mm/12,5"



Rocking Santoku (Con Alveolos)
Rocking Santoku Knife (Granton
Edge) // C. Rocking Santoku
(Alvéolé) // Coltello Rocking
Santoku (Con Alveole) // Rocking
Santoku (com Alveolos)



226400

200mm/8"
322mm/12,6"

Panero // Bread Knife (Serrated)
C. Pain (Cranté) // Coltello Pane
(Seghettato) // Para Pão (Perolado)

	Estuche	Case	Étui	Astuccio	Estojo
	Acero Inoxidable forjado NITRUM® Polioximetileno (POM)	NITRUM® Forged Stainless Steel Polyoxymethylene (POM)	Acier Inoxydable Forgé NITRUM® Polyoxyméthylène (POM)	Acciaio Inossidabile Forgiato NITRUM® Polioximetilene (POM)	Aço Inoxidável Forjado NITRUM® Polioximetileno (POM)



226200



Deshuesador // Boning Knife
C. À Désosser // Coltello Disosso
Para Desossar



226500



Deshuesador // Boning Knife
C. À Désosser // Coltello Disosso
Para Desossar



225900



Fileteador // Fillet Knife // C. À
Découper // Coltello Filettare
Filetar



226000

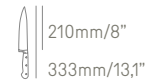

Fileteador // Fillet Knife // C. À
Découper // Coltello Filettare
Filetar



223300

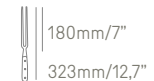

Tenedor Trinchante // Carving Fork
Fourchette // Forchettone // Garfo
Trinchante



225800





Chuletero // Steak Knife
C. Steak // Coltello Bistecca // Para
Costoletas



225000



Cocinero // Chef's Knife
C. Cuisine // Coltello Cucina
Cozinheiro

	Estuche	Case	Étui	Astuccio	Estojo
	Acero Inoxidable forjado NITRUM® Polioximetileno (POM)	NITRUM® Forged Stainless Steel Polyoxymethylene (POM)	Acier Inoxydable Forgé NITRUM® Polyoxyméthylène (POM)	Acciaio Inossidabile Forgiato NITRUM® Polioximetilene (POM)	Aço Inoxidável Forjado NITRUM® Polioximetileno (POM)



225100



Cocinero // Chef's Knife
C. Cuisine // Coltello Cucina
Cozinheiro



225200

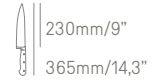

Cocinero // Chef's Knife
C. Cuisine // Coltello Cucina
Cozinheiro



225300

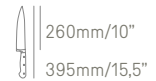

Cocinero // Chef's Knife
C. Cuisine // Coltello Cucina
Cozinheiro



226700



Jamonero (Flexible) // Slicing Knife (Flexible) // C. Jambon (Flexible)
Coltello Prosciutto (Flessibile)
Para Presunto (Flexível)



226800



Jamonero (Flexible) // Slicing Knife (Flexible) // C. Jambon (Flexible)
Coltello Prosciutto (Flessibile)
Para Presunto (Flexível)



2257



2249

2299



805900

Set 3 piezas // 3 Pc. Set // Set 3 Ctx.
Set 3 Pezzi // Conjunto 3 Peças



	Caja Regalo	Gift Box	Boîte Cadeau	Scatola Regalo	Caixa de Presente
	Acero Inoxidable forjado NITRUM® Polioximetileno (POM)	NITRUM® Forged Stainless Steel Polyoxymethylene (POM)	Acier Inoxydable Forgé NITRUM® Polyoxyméthylène (POM)	Acciaio Inossidabile Forgiato NITRUM® Polioximetilene (POM)	Aço Inoxidável Forjado NITRUM® Polioximetileno (POM)
	Madera de Haya Lacada Color Nogal	Walnut Lacquered Beech Wood	Bois de Hêtre laqué couleur Noyer	Legno di Faggio laccato in Color Noce	Madeira de Faia Lacada à Cor de Nogueira



227000

Juego 5 piezas // 5 Pc. Set // Bloc 5 Pièces // Ceppo 5 Pezzi // Conjunto 5 Peças



	Caja Regalo	Gift Box	Boîte Cadeau	Scatola Regalo	Caixa de Presente
	Acero Inoxidable forjado NITRUM® Polioximetileno (POM)	NITRUM® Forged Stainless Steel Polyoxymethylene (POM)	Acier Inoxydable Forgé NITRUM® Polyoxyméthylène (POM)	Acciaio Inossidabile Forgiato NITRUM® Polioximetilene (POM)	Aço Inoxidável Forjado NITRUM® Polioximetileno (POM)
	Madera de Caucho	Rubber Wood	Bois de Caoutchouc	Legno di Caucciù	Madeira de Borracha



228700

Juego 4 piezas // 4 Pc. Set // Bloc 4 Pièces // Ceppo 4 Pezzi // Conjunto 4 Peças



SÉRIE NÓRDIKA

Una serie que abraza la armonía de la naturaleza. Sus mangos de madera provienen de bosques sostenibles, perfectos para quienes buscan calidad, funcionalidad y respeto por el medio ambiente en su cocina.

A series that embraces the harmony of nature. The wood used to make their handles comes from sustainable forests, perfect for anyone who wants quality, practicality and respect for the environment in their kitchen.

Une série qui embrasse l'harmonie de la nature. Ses manches en bois sont issus de forêts durables, parfaits pour ceux qui recherchent la qualité, la fonctionnalité et le respect de l'environnement dans leur cuisine.

Una serie che accoglie l'armonia e la natura. I suoi manici in legno provengono da boschi sostenibili, perfetti per chi vuole qualità, funzionalità e rispetto per l'ambiente nella sua cucina.

Uma série que abraça a harmonia da natureza. Os seus cabos de madeira provêm de florestas sustentáveis, perfeitos para quem procura qualidade, funcionalidade e respeito pelo ambiente na sua cozinha.

EXCLUSIVE NITRUM®
STAINLESS STEEL

The wood of the NÓRDIKA Series
handles comes from well-managed
FSC® certified forests.

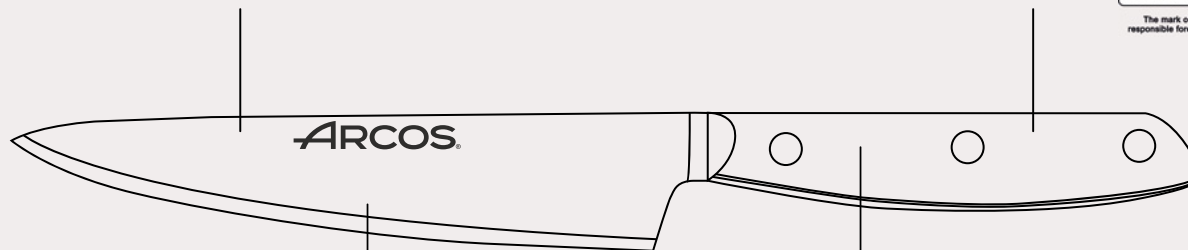

SILK EDGE



WOOD 100% FSC®



Acero Inoxidable NITRUM®

NITRUM® Stainless Steel · Acier Inoxydable NITRUM® · Acciaio
Inossidabile NITRUM® · Aço Inoxidável NITRUM®.



Filo Seda

Silk Edge · Silk Edge · Filo Seta · Fio Seda.



Recazo Redondeado

Rounded Back · Dos de Lame Adouci · Costola Arrotondata · Dorso
Arredondado.



Madera NATURAL

Natural Wood · Bois Naturel · Legno Naturale · Madeira
Natural.





Remaches de Latón

Brass Rivets · Rivets en Laiton · Rivetti in Ottone · Rebites
de Latão.



Packaging Reciclado

Recycled Packaging · Emballage Recyclé · Imballaggio
Riciclato · Embalagem Reciclada.

	Estuche	Case	Étui	Astuccio	Estojo
	Acero Inoxidable NITRUM® Madera de Ovengkol	NITRUM® Stainless Steel Ovengkolwood	Acier Inoxydable NITRUM® Bois d'Ovankol	Acciaio Inossidabile Forgiato NITRUM® Legno di Ovengkol	Aço Inoxidável Forjado NITRUM® Madeira de Ovengkol





164900

 100mm/4"
 230mm/9"

Chuletero // Steak Knife //
C. Steak Coltello Bistecca // Para Costoletas



165000

 100mm/4"
 203mm/8"

Mondador // Paring Knife
C. Office // Spelucchino
Descascador



166100

 125mm/5"
 240mm/9,4"

Queso // Cheese Knife
C. Fromage // Coltello Formaggio
Queijo



165100



 130mm/5"
 240mm/9,4"

Tomatero (Perlado) // Tomato Knife
(Serrated) // C. Citron-Tomate
(Craté) // Coltello Pomodoro
(Seghettato) // Para Tomate
(Perolado)



NEW

165300

 170mm/6,6"
 340mm/13,3"

Tenedor Trinchante // Carving Fork
Fourchette Diapason
Forchettone // Garfo Trinchante





NEW

165500

 200mm/8"
 340mm/13,3"

Trinchante // Carving knife
Couteau à Découper // Coltello
Trinciante // Faca de trincar

	Estuche	Case	Étui	Astuccio	Estojo
	Acero Inoxidable NITRUM® Madera de Ovengkol	NITRUM® Stainless Steel Ovengkolwood	Acier Inoxydable NITRUM® Bois d'Ovangkol	Acciaio Inossidabile Forgiato NITRUM® Legno di Ovengkol	Aço Inoxidável Forjado NITRUM® Madeira de Ovengkol



165400



140mm/5"

251mm/9,8"

Cocinero // Chef's Knife
C. Cuisine // Coltello Cucina
Cozinheiro



165900



160mm/6"

270mm/10,6"

Cocinero // Chef's Knife
C. Cuisine // Coltello Cucina
Cozinheiro



166800



210mm/8"

335mm/13,1"

Cocinero // Chef's Knife
C. Cuisine // Coltello Cucina
Cozinheiro



166400



200mm/8"

317mm/12,4"

Panero (Perlado) // Bread Knife
(Serrated) // C. Pain (Cranté)
Coltello Pane (Seghettato) // Para
Pão (Perolado)





166700



250mm/10"

315mm/12,4"

Jamonero Flexible // Slicing Knife
(Flexible) // C. Jambon (Flexible)
Coltello Prosciutto (Flessibile)
Para Presunto (Flexível)

	Estuche	Case	Étui	Astuccio	Estojo
	Acero Inoxidable NITRUM® Madera de Ovengkol	NITRUM® Stainless Steel Ovengkolwood	Acier Inoxydable NITRUM® Bois d'Ovankol	Acciaio Inossidabile Forgiato NITRUM® Legno di Ovengkol	Aço Inoxidável Forjado NITRUM® Madeira de Ovengkol



168100



 170mm/7"
 317mm/12,4"

Deba // Deba Knife
C. Deba // Coltello Deba // Deba



168000



 175mm/7"
 320mm/12,6"

Usuba // Usuba Knife // C. Usuba
Coltello Usuba // Usuba



166600





 190mm/7"
 315mm/12,4"

Santoku // Santoku Knife
C. Santoku // Coltello Santoku
Santoku



168200



 240mm/9"
 383mm/15"

Yanagiba // Yanagiba Knife
C. Yanagiba // Coltello Yanagiba
Yanagiba



1660

1662

1663

 60mm/2"
 170mm/7"



 135mm/5"
 248mm/10"

 130mm/5"
 248mm/10"



167200

Set C. Queso 3 Pzas. // 3 Pc.
Cheese K. Set // Set C. Fromage 3
Pièces // Set Coltello Formaggio 3
Pezzi // Conjunto Queijo 3 Peças

	Estuche	Case	Étui	Astuccio	Estojo
	Acero Inoxidable NITRUM® Madera de Øvengkol	NITRUM® Stainless Steel Øvengkolwood	Acier Inoxydable NITRUM® Bois d'Øvangkøl	Acciaio Inossidabile Forgiato NITRUM® Legno di Øvengkol	Aço Inoxidável Forjado NITRUM® Madeira de Øvengkol



1653



1655



167000

Set 2 piezas // 2 pc. Set // Set 2 pièces // Set 2 Pezzi // Conjunto 2 Peças



1650



1659



1668



167100

Set 3 piezas // 3 pc. Set // Set 3 Ctx. // Set 3 Pezzi // Conjunto 3 Peças



4 X 1649



NEW

167400

Set 4 piezas // 4 pc. Set // Set 4 Ctx. // Set 4 Pezzi // Conjunto 4 Peças



SERIE RIVIERA

En un tributo a la clásica elegancia francesa, la serie Riviera presenta su distinguida virola, fusionando arte y ergonomía en cada cuchillo forjado sin soldaduras, prometiendo no solo un corte, sino una experiencia culinaria.

In a tribute to the classic French elegance, the Riviera series presents its distinguished ferrule, uniting art and ergonomics in each knife forged without welding, promising not only a cut, but a culinary experience as well.

Hommage à la classique élégance française, la série Riviera dévoile sa mitre distinguée, fusionnant art et ergonomie dans chaque couteau forgé d'une seule pièce, promettant non seulement une coupe, mais une véritable expérience culinaire.

Come tributo alla classica eleganza francese, la serie Riviera presenta il suo particolare supporto che fonde arte ed ergonomía in ogni coltello forgiato senza saldature e che promette, non solamente un taglio, ma una vera esperienza culinaria.

Num tributo à elegância clássica francesa, a série Riviera apresenta uma virola distinta, fundindo arte e ergonomía em cada faca forjada sem soldagens, prometendo não apenas um corte, mas uma experiência culinária.

EXCLUSIVE NITRUM®
STAINLESS STEEL

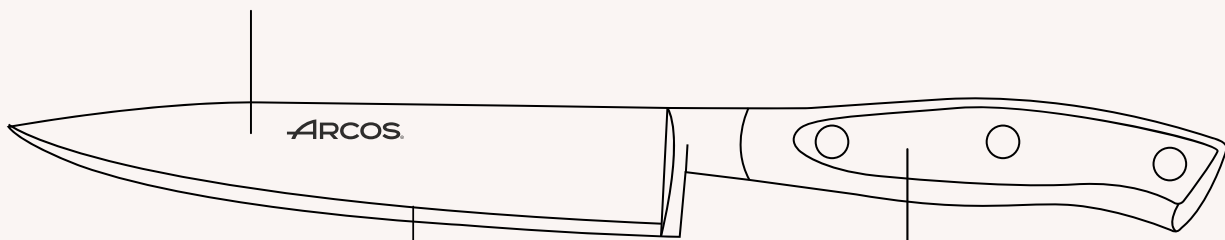

FORGED



POLIOXIMETILENO (POM)



Forjado

Forged · Forgé · Forgiato · Forjado.

Acero Inoxidable Forjado NITRUM®

NITRUM® Forged Stainless Steel · Acier Inoxydable Forgé NITRUM® · Acciaio Inossidabile Forgiato NITRUM® · Aço Inoxidável Forjado NITRUM®.



Plásticos Técnicos (POM)

Technical Plastics (POM) · Plastiques Techniques (POM) · Plastiche Tecniche (POM) · Plásticos Técnicos (POM)



Remaches de Acero Inox

Stainless Steel Rivets · Rivets en Acier Inoxydable · Rivetti In Acciaio Inossidabile · Rebites de Aço Inoxidável.



Virola con Diseño Francés



French Design Bolster · Mitre Design Français · Mitra Design Francese · Miter Design Francês.



National Sanitary Foundation



Bactiproof Silver®

	Estuche	Case	Étui	Astuccio	Estojo
	Acero Inoxidable forjado NITRUM® Polioximetileno (POM)	NITRUM® Forged Stainless Steel Polyoxymethylene (POM)	Acier Inoxydable Forgé NITRUM® Polyoxyméthylène (POM)	Acciaio Inossidabile Forgiato NITRUM® Polioximetilene (POM)	Aço Inoxidável Forjado NITRUM® Polioximetileno (POM)





230200

 100mm/4"
 202mm/7,9"

Mondador // Paring Knife
C. Office // Spelucchino
Descascador



230500

 130mm/5"
 230mm/9"

Chuletero // Steak Knife
C. Steak // Coltello Bistecca
Para Costoletas



230600

 150mm/6"
 271mm/10,6"

Cocina // Kitchen Knife
C. À Découper // Coltello Cucina
Cozinha





232000

 130mm/5"
 232mm/9,1"

Tomatero (Perlado) // Tomato Knife
(Serrated) // C. Citron-Tomates
(Cranté) // Coltello Pomodoro
(Seghettato) // Para Tomate
(Perolado)





232800

 145mm/6"
 292mm/11,4"

Queso // Cheese Knife
C. Fromage // Coltello Formaggio
Queijo



233300

 180mm/7"
 320mm/12,5"

Tenedor Trinchante // Carving Fork
Fourchette Diapason
Forchettone // Garfo Trinchante

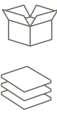
	Estuche	Case	Étui	Astuccio	Estojo
	Acero Inoxidable forjado NITRUM® Polioximetileno (POM)	NITRUM® Forged Stainless Steel Polyoxymethylene (POM)	Acier Inoxydable Forgé NITRUM® Polyoxyméthylène (POM)	Acciaio Inossidabile Forgiato NITRUM® Polioximetileno (POM)	Aço Inoxidável Forjado NITRUM® Polioximetileno (POM)



233200



140mm/5"
268mm/10,5"

Santoku (Con Alveolos)
Santoku Knife (Granton Edge)
C. Santoku (Alvéolé) // Coltello
Santoku (Con Alveole) // Santoku
(com Alvéolos)



233500



180mm/7"
309mm/12,1"

Santoku (Con Alveolos)
Santoku Knife (Granton Edge)
C. Santoku (Alvéolé) // Coltello
Santoku (Con Alveole) // Santoku
(com Alvéolos)



233100



180mm/7"
321mm/12,5"

Rocking Santoku (Con Alveolos)
Rocking Santoku Knife (Granton
Edge) // C. Rocking Santoku
(Alvéolé) // Coltello Rocking
Santoku (Con Alveole) // Rocking
Santoku (com Alvéolos)



233400

150mm/6"
272mm/10,7"

Cocinero // Chef's Knife
C. Cuisine // Coltello Cucina
Cozinheiro



233600

200mm/8"
327mm/12,8"

Cocinero // Chef's Knife
C. Cuisine // Coltello Cucina
Cozinheiro



233700

250mm/10"
378mm/14,8"



Cocinero // Chef's Knife
C. Cuisine // Coltello Cucina
Cozinheiro



233800

300mm/12"
434mm/17"

Cocinero // Chef's Knife
C. Cuisine // Coltello Cucina
Cozinheiro

	Estuche	Case	Étui	Astuccio	Estojo
	Acero Inoxidable forjado NITRUM® Polioximetileno (POM)	NITRUM® Forged Stainless Steel Polyoxymethylene (POM)	Acier Inoxydable Forgé NITRUM® Polyoxyméthylène (POM)	Acciaio Inossidabile Forgiato NITRUM® Polioximetileno (POM)	Aço Inoxidável Forjado NITRUM® Polioximetileno (POM)



231500

130mm/5,"
251mm/9,8"

Deshuesador // Boning Knife
C. A Désosser // Coltello Disosso
Para Desossar



232900

170mm/7"
291mm/11,4"

Lenguado (Flexible) // Sole
Knife (Flexible) // C. Filet de Sole
(Flexible) // Coltello Sogliola
(Flessibile) // Linguado (Flexível)



233000

200mm/8"
319mm/12,5"

Fileteador // Fillet Knife // C. À
Découper // Coltello Filettare
Filetar



231300

200mm/8"
323mm/12,7"

Panero // Bread Knife (Serrated)
C. Pain (Cranté) // Coltello Pane
(Seghettato) // Para Pão (Perolado)



231000

250mm/10"
374mm/14,7"



Jamonero (Flexible-Con Alveolos)
Slicing Knife (Flexible-Granton
Edge) // C. Jambon (Flexible-
Alvéolé) // Coltello Prosciutto
(Flessibile-Con Alveole)
Para Presunto (Flexível com
Alveolos)



231100

300mm/11"
418mm/16,4"

Jamonero (Flexible) // Slicing Knife
(Flexible) // C. Jambon (Flexible)
Coltello Prosciutto (Flessibile) //
Para Presunto (Flexível)

	Estuche	Case	Étui	Astuccio	Estojo
	Acero Inoxidable forjado NITRUM® Polioximetileno (POM)	NITRUM® Forged Stainless Steel Polyoxymethylene (POM)	Acier Inoxydable Forgé NITRUM® Polyoxyméthylène (POM)	Acciaio Inossidabile Forgiato NITRUM® Polioximetilene (POM)	Aço Inoxidável Forjado NITRUM® Polioximetileno (POM)

838310

Set 3 piezas // 3 pc. Set // Set 3 Ctx.
Set 3 Pezzi // Conjunto 3 Peças



2302 2334 2336





834200

Set 3 piezas // 3 pc. Set // Set 3 Ctx.
Set 3 Pezzi // Conjunto 3 Peças



2302 2334 2331



	Caja Regalo	Gift Box	Boîte Cadeau	Scatola Regalo	Caixa de Presente
	Acero Inoxidable forjado NITRUM® Polioximetileno (POM)	NITRUM® Forged Stainless Steel Polyoxymethylene (POM)	Acier Inoxydable Forgé NITRUM® Polyoxyméthylène (POM)	Acciaio Inossidabile Forgiato NITRUM® Polioximetilene (POM)	Aço Inoxidável Forjado NITRUM® Polioximetileno (POM)
	Madera de Haya	BeechWood	Bois de Hêtre	Legno di Faggio	Madeira de Faia

234200

Juego 6 piezas // 6 pc. Set // Bloc 6
Pièces // Ceppo 6 Pezzi // Conjunto
6 Peças



2302 2334 2336 2313 2310 2784

234300

Juego 5 piezas // 5 pc. Set // Bloc 5
Pièces // Ceppo 5 Pezzi // Conjunto
5 Peças



1853 2302 2336 2313 2310



SERIE RIVIERA BLANC

Con esta serie la pureza del blanco se funde con la precisión del acero. Cada cuchillo es una obra de arte, ofreciendo cortes exquisitos y una estética impecable que ilumina cualquier cocina.

With this series the white pureness blends in with the steel precision. Each knife is a work of art, making exquisite cuts, with an impeccable look that enlightens any kitchen.

Avec cette série, la pureté du blanc se mêle à la précision de l'acier. Chaque couteau devient une pièce d'art, offrant des coupes exquisites et une esthétique impecable qui illumine toute cuisine.

In questa serie la purezza del bianco si fonde con la precisione dell'acciaio. Ogni coltello è un'opera d'arte che offre tagli squisiti e un'estetica impeccabile, per illuminare qualsiasi cucina.

Com esta série, a pureza do branco encontra-se com a precisão do aço. Cada faca é uma obra de arte, oferecendo cortes requintados e uma estética impecável que ilumina qualquer cozinha.

EXCLUSIVE NITRUM®
STAINLESS STEEL



FORGED

POLIOXIMETILENO (POM)



Forjado

Forged • Forgé • Forgiato • Forjado.

Acero Inoxidable Forjado NITRUM®

NITRUM® Forged Stainless Steel • Acier Inoxydable Forgé NITRUM® • Acciaio Inossidabile Forgiato NITRUM® • Aço Inoxidável Forjado NITRUM®.



Plásticos Técnicos (POM)

Technical Plastics (POM) • Plastiques Techniques (POM) • Plastiche Tecniche (POM) • Plásticos Técnicos (POM)



Remaches de Acero Inox

Stainless Steel Rivets • Rivets en Acier Inoxydable • Rivetti In Acciaio Inossidabile • Rebites de Aço Inoxidável.



Virola con Diseño Francés



French Design Bolster • Mitre Design Français • Mitra Design Francese • Miter Design Francês.



National Sanitary Foundation



Bactiproof Silver®

	Estuche	Case	Étui	Astuccio	Estojo
	Acero Inoxidable forjado NITRUM® Polioximetileno (POM)	NITRUM® Forged Stainless Steel Polyoxymethylene (POM)	Acier Inoxydable Forgé NITRUM® Polyoxyméthylène (POM)	Acciaio Inossidabile Forgiato NITRUM® Polioximetilene (POM)	Aço Inoxidável Forjado NITRUM® Polioximetileno (POM)



230224

100mm/4"
202mm/7,9"

Mondador // Paring Knife
C. Office // Spelucchino
Descascador



230524

130mm/5"
230mm/9"

Chuletero // Steak Knife
C. Steak // Coltello Bistecca
Para Costoletas



230624

150mm/6"
271mm/10,6"

Cocina // Kitchen Knife
C. À Découper // Coltello Cucina
Cozinha



232024

130mm/5"
232mm/9,1"

Tomatero (Perlado) // Tomato Knife
(Serrated) // C. Citron-Tomates
(Cranté) // Coltello Pomodoro
(Seghettato) // Para Tomate
(Perolado)



232824

145mm/6"
292mm/11,4"



Queso // Cheese Knife
C. Fromage // Coltello Formaggio
Queijo



233324

180mm/7"
320mm/12,5"

Tenedor Trinchante // Carving Fork
Fourchette Diapason
Forchettone // Garfo Trinchante

	Estuche	Case	Étui	Astuccio	Estojo
	Acero Inoxidable forjado NITRUM® Polioximetileno (POM)	NITRUM® Forged Stainless Steel Polyoxymethylene (POM)	Acier Inoxydable Forgé NITRUM® Polyoxyméthylène (POM)	Acciaio Inossidabile Forgiato NITRUM® Polioximetilene (POM)	Aço Inoxidável Forjado NITRUM® Polioximetileno (POM)



233224



140mm/5"
268mm/10,5"

Santoku (Con Alveolos)
Santoku Knife (Granton Edge)
C. Santoku (Alvéolé) // Coltello
Santoku (Con Alveole) // Santoku
(com Alveolos)



233524



180mm/7"
309mm/12,1"

Santoku (Con Alveolos)
Santoku Knife (Granton Edge)
C. Santoku (Alvéolé) // Coltello
Santoku (Con Alveole) // Santoku
(com Alveolos)



233124



180mm/7"
321mm/12,6"

Rocking Santoku (Con Alveolos)
Rocking Santoku Knife (Granton Edge) // C. Rocking Santoku
(Alvéolé) // Coltello Rocking
Santoku (Con Alveole) // Rocking
Santoku (com Alveolos)



233424

150mm/6"
272mm/10,7"

Cocinero // Chef's Knife
C. Cuisine // Coltello Cucina
Cozinheiro



233624

200mm/8"
327mm/12,8"

Cocinero // Chef's Knife
C. Cuisine // Coltello Cucina
Cozinheiro



233724

250mm/10"
378mm/14,8"

Cocinero // Chef's Knife
C. Cuisine // Coltello Cucina
Cozinheiro



233824

300mm/12"
434mm/17"

Cocinero // Chef's Knife
C. Cuisine // Coltello Cucina
Cozinheiro

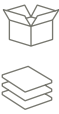
	Estuche Acero Inoxidable forjado NITRUM® Polioximetileno (POM)	Case NITRUM® Forged Stainless Steel Polyoxymethylene (POM)	Étui Acier Inoxydable Forgé NITRUM® Polyoxyméthylène (POM)	Astuccio Acciaio Inossidabile Forgiato NITRUM® Polioximetileno (POM)	Estojo Aço Inoxidável Forjado NITRUM® Polioximetileno (POM)
--	--	--	--	--	---



231524

 130mm/5"
251mm/9,8"

Deshuesador // Boning Knife
C. A Désosser // Coltello Disosso
Para Desossar



232924

 170mm/7"
291mm/11,45"

Lenguado (Flexible) // Sole
Knife (Flexible) // C. Filet de Sole
(Flexible) // Coltello Sogliola
(Flessibile) // Linguado (Flexível)



233024

 200mm/8"
319mm/12,5"

Fileteador // Fillet Knife // C. À
Découper // Coltello Filettare
Filetar



231324

 200mm/8"
323mm/12,7"

Panero // Bread Knife (Serrated)
C. Pain (Cranté) // Coltello Pane
(Seghettato) // Para Pão (Perolado)



231024

 250mm/10"
374mm/14,7"



Jamonero (Flexible-Con Alveolos)
Slicing Knife (Flexible-Granton
Edge) // C. Jambon (Flexible-
Alvéolé) // Coltello Prosciutto
(Flessibile-Con Alveole)
Para Presunto (Flexível com
Alveolos)



231124

 300mm/11"
418mm/16,4"



Jamonero (Flexible) // Slicing Knife
(Flexible) // C. Jambon (Flexible)
Coltello Prosciutto (Flessibile)
Para Presunto (Flexível)

	Estuche	Case	Étui	Astuccio	Estojo
	Acero Inoxidable forjado NITRUM® Polioximetileno (POM)	NITRUM® Forged Stainless Steel Polyoxymethylene (POM)	Acier Inoxydable Forgé NITRUM® Polyoxyméthylène (POM)	Acciaio Inossidabile Forgiato NITRUM® Polioximetilene (POM)	Aço Inoxidável Forjado NITRUM® Polioximetileno (POM)



838410

Set 3 piezas // 3 pc. Set // Set 3 Pièces
Ceppo 3 Pezzi // Set 3 Peças

	Caja Regalo	Gift Box	Boîte Cadeau	Scatola Regalo	Caixa de Presente
	Acero Inoxidable forjado NITRUM® Polioximetileno (POM)	NITRUM® Forged Stainless Steel Polyoxymethylene (POM)	Acier Inoxydable Forgé NITRUM® Polyoxyméthylène (POM)	Acciaio Inossidabile Forgiato NITRUM® Polioximetilene (POM)	Aço Inoxidável Forjado NITRUM® Polioximetileno (POM)
	Madera de Caucho (235024) Madera de Haya (234524)	Rubber Wood (235024) BeechWood (234524)	Bois de Caoutchouc (235024) Bois de Hêtre (234524)	Legno di Caucciù (235024) Legno di Faggio (234524)	Madeira de Borracha (235024) Madeira de Faia (234524)

235024

Juego 5 piezas // 5 pc. Set // Bloc 5 Pièces
Ceppo 5 Pezzi // Conjunto 5 Peças

234524

Juego 5 piezas // 5 pc. Set // Bloc 5 Pièces
Ceppo 5 Pezzi // Conjunto 5 Peças





SERIE CLARA

Cada cuchillo Clara es un homenaje a los cocineros apasionados, uniendo hojas de precisión con mangos más sencillos y ergonómicos para una cocina intuitiva y accesible a todos.

Each Clara knife pays tribute to avid cooks, uniting precision blades with the simplest and most ergonomic handles for intuitive cooking, which are accessible to all.

Chaque couteau Clara est un hommage aux cuisiniers passionnés, mariant des lames de précision à des manches plus simples et plus ergonomiques pour une cuisine intuitive et accessible à tous.

Ogni coltello Clara è un tributo ai cuochi appassionati, giacché unisce delle lame di precisione a manici più semplici ed ergonomici, per una cucina intuitiva e accessibile a tutti.

Cada faca Clara é um tributo aos cozinheiros apaixonados, combinando lâminas de precisão com cabos mais simples e ergonómicos para uma cozinha intuitiva e acessível a todos.

EXCLUSIVE NITRUM®
STAINLESS STEEL

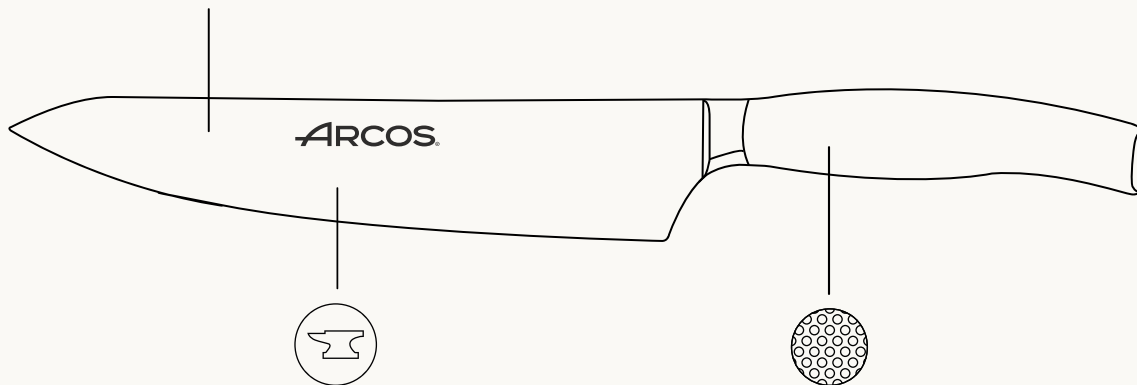

FORGED

POLIPROPILENO (PP)



Forjado

Forged · Forgé · Forgiato · Forjado.

Acero Inoxidable Forjado NITRUM®



NITRUM® Forged Stainless Steel · Acier Inoxydable Forgé NITRUM® · Acciaio Inossidabile Forgiato NITRUM® Aço Inoxidável Forjado NITRUM®.

Inyección

Inyección · Injection · Iniection · Iniezione · Inveçção .

Plásticos Técnicos (PP)

Technical Plastics (PP) · Plastiques Techniques (PP) · Plastiche Tecniche (PP) · Plásticos Técnicos (PP) .

	Funda Display	Display Sleeve	Carte	Display	Display
	Acero Inoxidable forjado NITRUM® Polipropileno (PP)	NITRUM® Forged Stainless Steel Polypropylene (PP)	Acier Inoxydable Forgé NITRUM® Polypropylène (PP)	Acciaio Inossidabile Forgiato NITRUM® Polipropilene (PP)	Aço Inoxidável Forjado NITRUM® Polipropileno (PP)



210100

 100mm/4"
212mm/8,3"

Mondador // Paring Knife
C. Office // Spelucchino
Descascador



211100

 130mm/5"
240mm/9,4"

Verduras // Vegetable Knife
C. Office // Coltello Verdura
Legumes



210400

 150mm/6"
278mm/10,9"

Cocinero // Chef's Knife
C. Cuisine // Coltello Cucina
Cozinheiro



210600

 200mm/8"
341mm/13,4"

Cocinero // Chef's Knife
C. Cuisine // Coltello Cucina
Cozinheiro



210700

 200mm/8"
326mm/12,8"



Panero (Perlado) // Bread Knife
(Serrated) C. Pain (Cranté)
Coltello Pane (Seghettato) // Para
Pão (Perolado)



211900

 250mm/10"
377mm/14,8"



Jamonero (Flexible) // Slicing Knife
(Flexible) // C. Jambon (Flexible)
Coltello Prosciutto (Flessibile)
Para Presunto (Flexível)

	Estuche	Case	Étui	Astuccio	Estojo
	Acero Inoxidable forjado NITRUM® Polipropileno (PP)	NITRUM® Forged Stainless Steel Polypropylene	Acier Inoxydable Forgé NITRUM® Polypropylène	Acciaio Inossidabile Forgiato NITRUM® Polipropilene	Aço Inoxidável Forjado NITRUM® Polipropileno



212000

Set 3 piezas // 3 pc. Set // Set 3 Ctx.
Set 3 Pezzi // Conjunto 3 Peças

	Caja Regalo	Gift Box	Boîte Cadeau	Scatola Regalo	Caixa de Presente
	Acero Inoxidable forjado NITRUM® Polipropileno (PP)	NITRUM® Forged Stainless Steel Polypropylene	Acier Inoxydable Forgé NITRUM® Polypropylène	Acciaio Inossidabile Forgiato NITRUM® Polipropilene	Aço Inoxidável Forjado NITRUM® Polipropileno
	Plástico Interior de Fibras de Caucho	Plastic Rubber Fibre Interior	Plastique Intérieur - Fibras de Caoutchouc	Plastica Interno in Fibre di Gomma	Plástico Interior de Fibras de Borracha



212100

Juego 4 piezas // 4 Pc. Set // Bloc
4 Ctx // Ceppo 4 Pezzi // Conjunto
4 Peças

	Caja Regalo	Gift Box	Boîte Cadeau	Scatola Regalo	Caixa de Presente
	Acero Inoxidable forjado NITRUM® Polipropileno (PP)	NITRUM® Forged Stainless Steel Polypropylene (PP)	Acier Inoxydable Forgé NITRUM® Polypropylène (PP)	Acciaio Inossidabile Forgiato NITRUM® Polipropilene (PP)	Aço Inoxidável Forjado NITRUM®
	Madera de Pino	Pine wood	Bois de pin	Legno di pino	Madeira de Pinho



212200

Juego 5 piezas // 5 Pc. Set // Bloc 5
Pièces // Ceppo 5 Pezzi // Conjunto
5 Peças



212300

Juego 5 piezas // 5 Pc. Set // Bloc 5
Pièces // Ceppo 5 Pezzi // Conjunto
5 Peças



SERIE UNIVERSAL HOME

Perfecta sinergia entre práctica culinaria y confort. Cuchillos esenciales en la cocina del hogar, diseñados para entusiastas y chefs, garantizando cortes precisos y un manejo excepcional.

The perfect synergy between the culinary practice and comfort. Essential knives in the kitchen at home, designed for enthusiasts and chefs, which guarantee precise cuts and an exceptional performance.

Une synergie parfaite entre la pratique culinaire et le confort. Des couteaux indispensables dans la cuisine domestique, conçus pour les passionnés et les chefs, assurant des coupes précises et une manipulation exceptionnelle.

Perfecta sinergia tra pratica culinaria e confort. Coltelli essenziali nella cucina di casa, progettati per appassionati e chef, che garantiscono tagli precisi e un maneggio eccezionale.

Sinergia perfeita entre prática culinária e conforto. Facas essenciais na cozinha doméstica, concebidas para entusiastas garantindo cortes precisos e um manuseamento excepcional.



Acero Inoxidable NITRUM®

NITRUM® Stainless Steel · Acier Inoxydable NITRUM® · Acciaio Inossidabile NITRUM® · Aço Inoxidável NITRUM®.



Bactiproof Silver®



Remaches de Acero Inox

Stainless Steel Rivets · Rivets en Acier Inoxydable · Rivetti in Acciaio Inossidabile · Rebites de Aço Inoxidável.



Plásticos Técnicos (POM)

Technical Plastics (Polyoxymethylene) · Plastiques Techniques (Polyoxyméthylène) · Plastiche Tecniche (Polioximetilene) · Plásticos Técnicos (Polioximetileno).





Resistente Altas Temperaturas

High-Temperature Resistant · Résistant Aux Hautes Températures · Resistente Alle Alte Temperature · Resistente a Altas Temperaturas.



NSF National Sanitary Foundation

	Estuche	Case	Étui	Astuccio	Estojo
	Acero Inoxidable NITRUM® Polioximetileno (POM)	NITRUM® Stainless Steel Polyoxymethylene (POM)	Acier Inoxydable NITRUM® Polyoxyméthylène (POM)	Acciaio Inossidabile NITRUM® Polioximetilene (POM)	Aço Inoxidável NITRUM® Polioximetileno (POM)



280004

 60mm/2"
160mm/6,2"

Mondador (Curvo) // Paring Knife (Curved) // C. Office (Courbé) // Spelucchino (Curvato) Descascador (Curva)



280104

 75mm/3"
178mm/7"

Mondador // Paring Knife C. Office // Spelucchino Descascador



281004

 75mm/3"
178mm/7"

Mondador // Paring Knife C. Office // Spelucchino Descascador



289004

 60mm/2"
183mm/7,2"

Abre Ostras // Oyster Knife C. Ouvre Huitres // Apri-Ostriche Abre Ostras



281104

 100mm/4"
202mm/7,9"

Verduras // Vegetable Knife C. Office // Coltello Verdura Legumes



282504

 130mm/5"
260mm/10,2"

Deshuesador // Boning Knife C. À Désosser // Coltello Disosso Para Desossar



282604

 160mm/6"
288mm/11,3"



Deshuesador // Boning Knife C. À Désosser // Coltello Disosso Para Desossar



282704

 160mm/6"
275mm/10,8"

Fileteador (Flexible) // Fillet Knife (Flexible) // C. Fillet de Sole (Flexible) // Coltello Filettare Pesce (Flessibile) // Filetar (Flexível)

	Estuche	Case	Étui	Astuccio	Estojo
	Acero Inoxidable NITRUM® Polioximetileno (POM)	NITRUM® Stainless Steel Polyoxymethylene (POM)	Acier Inoxydable NITRUM® Polyoxyméthylène (POM)	Acciaio Inossidabile NITRUM® Polioximetilene (POM)	Aço Inoxidável NITRUM® Polioximetileno (POM)



289104

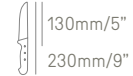

Tomatero (Perlado) // Tomato Knife (Serrated) // C. Citron-Tomate (Cranté) // Coltello Pomodoro (Seghettato) // Para Tomate (Perlado)



281204



Cocina // Kitchen Knife C. À Découper // Coltello Cucina Cozinha



281304



Cocina // Kitchen Knife C. À Découper // Coltello Cucina Cozinha



281404



Cocina // Kitchen Knife C. À Découper // Coltello Cucina Cozinha



284204





Lenguado (Flexible) // Sole Knife (Flexible) // C. Filet de Sole (Flexible) // Coltello Sogliola (Flessibile) // Linguado (Flexível)



281504



Trinchante // Carving knife Couteau À Découper // Coltello Trinciante // Faca de trinchar

 	Estuche Acero Inoxidable NITRUM® Polioximetileno (POM)	Case NITRUM® Stainless Steel Polyoxymethylene (POM)	Étui Acier Inoxydable NITRUM® Polyoxyméthylène (POM)	Astuccio Acciaio Inossidabile NITRUM® Polioximetilene (POM)	Estojo Aço Inoxidável NITRUM® Polioximetileno (POM)
---	---	--	---	--	--



281704

 140mm/5"
260mm/10,2"

Cocinero // Chef's Knife
C. Cuisine // Coltello Cucina
Cozinheiro



284604

 150mm/6"
270mm/10,6"

Cocinero // Chef's Knife
C. Cuisine // Coltello Cucina
Cozinheiro



284704

 170mm/7"
290mm/11,4"

Cocinero // Chef's Knife
C. Cuisine // Coltello Cucina
Cozinheiro



284804

 200mm/8"
323mm/12,7"

Cocinero // Chef's Knife
C. Cuisine // Coltello Cucina
Cozinheiro



284100

 160mm/6"
268mm/10,5"



Tenedor Trinchanté // Carving Fork
Fourchette Diapason
Forchettone // Garfo Trinchanté



281604

 145mm/6"
277mm/10,9"

Queso // Cheese Knife
C. Fromage // Coltello Formaggio
Queijo

	Estuche	Case	Étui	Astuccio	Estojo
	Acero Inoxidable NITRUM® Polioximetileno (POM)	NITRUM® Stainless Steel Polyoxymethylene (POM)	Acier Inoxydable NITRUM® Polyoxyméthylène (POM)	Acciaio Inossidabile NITRUM® Polioximetileno (POM)	Aço Inoxidável NITRUM® Polioximetileno (POM)



280204



Cocinero // Chef's Knife
C. Cuisine // Coltello Cucina
Cozinheiro



280304



Cocinero // Chef's Knife
C. Cuisine // Coltello Cucina
Cozinheiro



280404



Cocinero // Chef's Knife
C. Cuisine // Coltello Cucina
Cozinheiro



280504



Cocinero // Chef's Knife
C. Cuisine // Coltello Cucina
Cozinheiro



280604





Cocinero // Chef's Knife
C. Cuisine // Coltello Cucina
Cozinheiro



280601



Cocinero (con Alveolos) // Chef's
Knife (Granton Edge) // C. Cuisine
(Alvéolé) // Coltello Cucina
(Con Alveole) // Cozinheiro (Com
Alveolos)

	Estuche	Case	Étui	Astuccio	Estojo
	Acero Inoxidable NITRUM® Polioximetileno (POM)	NITRUM® Stainless Steel Polyoxymethylene (POM)	Acier Inoxydable NITRUM® Polyoxyméthylène (POM)	Acciaio Inossidabile NITRUM® Polioximetilene (POM)	Aço Inoxidável NITRUM® Polioximetileno (POM)



280704

 250mm/10"
390mm/15,3"

Cocinero // Chef's Knife
C. Cuisine // Coltello Cucina
Cozinheiro



280804

 300mm/12"
440mm/17,3"

Cocinero // Chef's Knife
C. Cuisine // Coltello Cucina
Cozinheiro



282104

 200mm/8"
320mm/12,5"

Panero (Perlado) // Bread Knife
(Serrated) // C. Pain (Cranté)
Coltello Pane (Seghettato) // Para
Pão (Perolado)



282204

 250mm/10"
374mm/14,7"

Panero (Perlado) // Bread Knife
(Serrated) // C. Pain (Cranté)
Coltello Pane (Seghettato) // Para
Pão (Perolado)



283904

 250mm/10"
383mm/15"



Pastelero (Perlado) // Pastry Knife
(Serrated) // C. Genoise (Cranté)
Coltello Pasticceria-Pane
(Seghettato) // Pasteleiro
(Perolado)



284304

 300mm/12"
424mm/16,6"

Pastelero (Perlado) // Pastry Knife
(Serrated) // C. Genoise (Cranté)
Coltello Pasticceria-Pane
(Seghettato) // Pasteleiro
(Perolado)

	Estuche	Case	Étui	Astuccio	Estojo
	Acero Inoxidable NITRUM® Polioximetileno (POM)	NITRUM® Stainless Steel Polyoxymethylene (POM)	Acier Inoxydable NITRUM® Polyoxyméthylène (POM)	Acciaio Inossidabile NITRUM® Polioximetileno (POM)	Aço Inoxidável NITRUM® Polioximetileno (POM)



281801



Jamonero (Flexible-Con Alveolos)
Slicing Knife (Flexible-Granton Edge) // C. Jambon (Flexible-Alvéolé) // Coltello Prosciutto (Flessibile-Con Alveole)
Para Presunto (Flexível com Alveolos)



281804



Jamonero (Flexible) // Slicing Knife (Flexible) // C. Jambon (Flexible) Coltello Prosciutto (Flessibile) Para Presunto (Flexível)



281901



Jamonero (Flexible-Con Alveolos)
Slicing Knife (Flexible-Granton Edge) // C. Jambon (Flexible-Alvéolé) // Coltello Prosciutto (Flessibile-Con Alveole)
Para Presunto (Flexível com Alveolos)



281904



Jamonero (Flexible) // Slicing Knife (Flexible) // C. Jambon (Flexible) Coltello Prosciutto (Flessibile) Para Presunto (Flexível)



282004





Jamonero (Flexible) // Slicing Knife (Flexible) // C. Jambon (Flexible) Coltello Prosciutto (Flessibile) Para Presunto (Flexível)



283804



Fiambre (Ancho) // Slicing Knife (Wide) // C. Jambon (Large) Coltello Prosciutto (Largo) Fiambre Salmão (Largo)

	Estuche	Case	Étui	Astuccio	Estojo
	Acero Inoxidable NITRUM® Polioximetileno (POM)	NITRUM® Stainless Steel Polyoxymethylene (POM)	Acier Inoxydable NITRUM® Polyoxyméthylène (POM)	Acciaio Inossidabile NITRUM® Polioximetilene (POM)	Aço Inoxidável NITRUM® Polioximetileno (POM)



289904

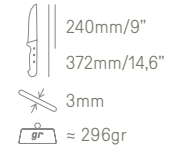

Yanagiba // Yanagiba Knife
C. Yanagiba // Coltello Yanagiba
Yanagiba



286004

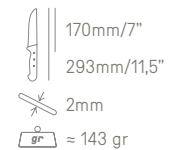

Santoku (Con Alveolos)
Santoku Knife (Granton Edge)
C. Santoku (Alvéolé) // Coltello
Santoku (Con Alveole) // Santoku
(Com Alveolos)



288804

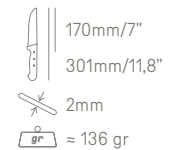

Santoku // Santoku Knife
C. Santoku // Coltello Santoku
Santoku



289804

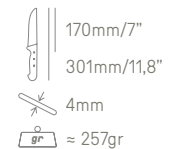



Deba // Deba Knife
C. Deba // Coltello Deba // Deba



289704



Usuba // Usuba Knife
C. Usuba // Coltello Usuba // Usuba

	Estuche	Case	Étui	Astuccio	Estojo
	Acero Inoxidable NITRUM® Polioximetileno (POM)	NITRUM® Stainless Steel Polyoxymethylene (POM)	Acier Inoxydable NITRUM® Polyoxyméthylène (POM)	Acciaio Inossidabile NITRUM® Polioximetilene (POM)	Aço Inoxidável NITRUM® Polioximetileno (POM)



283704





Salmón // (Ancho-Con Alveolos)
Salmon Knife (Wide-Granton Edge)
C. Saumon (Large-Alvéolé)
Coltello Salmone (Largo-Con Alveole) // Salmão (Largo com Alvéolos)



284004



Salmón // (Flexible-Con Alveolos)
Salmon Knife (Flexible-Granton Edge) // C. Saumon (Flexible-Alvéolé) // Coltello Salmone (Flessibile-Con Alveole) // Salmão (Flexível com Alvéolos)



	Estuche	Case	Étui	Astuccio	Estojo
	Acero Inoxidable NITRUM® Polioximetileno (POM)	NITRUM® Stainless Steel Polyoxymethylene (POM)	Acier Inoxydable NITRUM® Polyoxyméthylène (POM)	Acciaio Inossidabile NITRUM® Polioximetilene (POM)	Aço Inoxidável NITRUM® Polioximetileno (POM)



288400



Macheta China // Chinese Cleaver
Couperet Chinois // Mannaietta
Cinesa // Cutelo Chinês

	Funda Display	Display Sleeve	Carte	Display	Capa Expositora
	Acero Inoxidable NITRUM® Polioximetileno (POM)	NITRUM® Stainless Steel Polyoxymethylene (POM)	Acier Inoxydable NITRUM® Polyoxyméthylène (POM)	Acciaio Inossidabile NITRUM® Polioximetilene (POM)	Aço Inoxidável NITRUM® Polioximetileno (POM)



282404

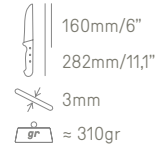

**Hachuela // Cleaver // Feuille
Mannaïetta // Machados**



288200

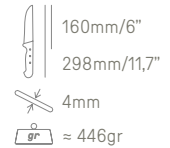

**Macheta // Cleaver // Couperet
Mannaïetta // Machete**



288300





**Macheta China // Chinese Cleaver
Couperet Chinois // Mannaïetta
Cinesa // Cutelo Chinês**



286600



**Espátula // Spatula // Spatule à
Lasagne // Spatola // Espátula**

	Funda Display	Display Sleeve	Carte	Display	Capa Expositora
	Acero Inoxidable NITRUM® Polioximetileno (POM)	NITRUM® Stainless Steel Polyoxymethylene (POM)	Acier Inoxydable NITRUM® Polyoxyméthylène (POM)	Acciaio Inossidabile NITRUM® Polioximetilene (POM)	Aço Inoxidável NITRUM® Polioximetileno (POM)



286400

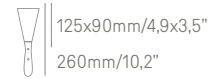



Espátula // Spatula // Spatule à Lasagne // Spatola // Espátula



286500



Espátula // Spatula // Spatule à Lasagne // Spatola // Espátula

	Estuche	Case	Étui	Astuccio	Estojo
	Acero Inoxidable NITRUM® Polioximetileno (POM)	NITRUM® Stainless Steel Polyoxymethylene (POM)	Acier Inoxydable NITRUM® Polyoxyméthylène (POM)	Acciaio Inossidabile NITRUM® Polioximetilene (POM)	Aço Inoxidável NITRUM® Polioximetileno (POM)



286104



Espátula // Spatula // Spatule // Spatola // Espátula



286204



Espátula // Spatula // Spatule // Spatola // Espátula



286304

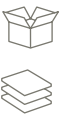

Espátula // Spatula // Spatule // Spatola // Espátula

	Estuche	Case	Étui	Astuccio	Estojo
	Acero Inoxidable NITRUM® Polioximetileno (POM)	NITRUM® Stainless Steel Polyoxymethylene (POM)	Acier Inoxydable NITRUM® Polyoxyméthylène (POM)	Acciaio Inossidabile NITRUM® Polioximetilene (POM)	Aço Inoxidável NITRUM® Polioximetileno (POM)

285800

Juego 2 pzas. // 2 pc. Set
Ensemble 2 Ctx. // Set 2 Pezzi
Conjunto 2 Peças



2811 2806



285500

Juego 2 pzas. // 2 pc. Set
Ensemble 2 pièces // Set 2 Pezzi
Conjunto 2 Peças



7821 2818



	Estuche	Case	Étui	Astuccio	Estojo
	Acero Inoxidable Nitrum® Polioximetileno (POM)	NITRUM® Stainless Steel Polyoxymethylene (POM)	Acier Inoxydable NITRUM® Polyoxyméthylène (POM)	Acciaio Inossidabile NITRUM® Polioximetilene (POM)	Aço Inoxidável NITRUM® Polioximetileno (POM)





2802 2806 2846



807410

Set 3 piezas // 3 pc. Set // Set 3 Ctx.
Set 3 Pezzi // Conjunto 3 Peças



	Caja Regalo	Gift Box	Boîte Cadeau	Scatola Regalo	Caixa de Presente
	Acero Inoxidable NITRUM® Polioximetileno (POM)	NITRUM® Stainless Steel Polyoxymethylene (POM)	Acier Inoxydable NITRUM® Polyoxyméthylène (POM)	Acciaio Inossidabile NITRUM® Polioximetileno (POM)	Aço Inoxidável NITRUM® Polioximetileno (POM)
	Madera de Haya	Beech Wood	Bois de Hêtre	Legno di Faggio	Madeira de Faia



285600

Juego 6 piezas // 6 pc. Set
Bloc 6 Pièces // Ceppo 6 Pezzi
Conjunto 6 Peças





	Caja Regalo	Gift Box	Boîte Cadeau	Scatola Regalo	Caixa de Presente
	Acero Inoxidable NITRUM® Polioximetileno (POM)	NITRUM® Stainless Steel Polyoxymethylene (POM)	Acier Inoxydable NITRUM® Polyoxyméthylène (POM)	Acciaio Inossidabile NITRUM® Polioximetileno (POM)	Aço Inoxidável NITRUM® Polioximetileno (POM)
	Madera de Caucho	Rubber Wood	Bois de Caoutchouc	Legno di Caucciù	Madeira de Borracha



285000

Juego 4 piezas // 4 pc. Set // Bloc 4
Pièces // Ceppo 4 Pezzi // Conjunto
4 Peças





	Caja Regalo	Gift Box	Boîte Cadeau	Scatola Regalo	Caixa de Presente
	Acero Inoxidable NITRUM® Polioximetileno (POM)	NITRUM® Stainless Steel Polyoxymethylene (POM)	Acier Inoxydable NITRUM® Polyoxyméthylène (POM)	Acciaio Inossidabile Polioximetilene (POM)	Aço Inoxidável NITRUM® Polioximetileno (POM)
	Madera de Pino	Pine wood	Bois de pin	Legno di pino	Madeira de Pinho



285100

Juego 6 piezas // 6 pc. Set
Bloc 6 Pièces // Ceppo 6 Pezzi
Conjunto 6 Peças



	Caja Regalo	Gift Box	Boîte Cadeau	Scatola Regalo	Caixa de Presente
	Acero Inoxidable NITRUM® Polioximetileno (POM)	NITRUM® Stainless Steel Polyoxymethylene (POM)	Acier Inoxydable NITRUM® Polyoxyméthylène (POM)	Acciaio Inossidabile NITRUM® Polioximetilene (POM)	Aço Inoxidável NITRUM® Polioximetileno (POM)
	Madera de Haya Lacada Color Nogal	Walnut Lacquered Beech Wood	Bois de Hêtre Couleur Noyer Couleur Noyer	Legno di Faggio Laccato in Color Noce	Madeira de Faia Lacada À Cor de Nogueira



285700

Juego 5 piezas // Juego 5 pzas.
5 pc. set // Bloc 5 Ctx. // Ceppo 5
Pezzi // Conjunto 5 Peças





SERIE MAITRE

Diseñados para armonizar con cada movimiento, nuestros cuchillos ofrecen un agarre intuitivo y curvas amables que se complementan con tu ritmo en la cocina, asegurando precisión y durabilidad en cada corte.

Designed to harmonise each movement, our knives provide an intuitive grip and pleasant curves that complement your pace in the kitchen, ensuring precision and stability in each cut.

Conçus pour s'harmoniser avec chaque mouvement, nos couteaux offrent une prise en main intuitive et des courbes douces qui complètent votre rythme dans la cuisine, assurant précision et durabilité dans chaque coupe.

Progettati per armonizzarsi ad ogni movimento, i nostri coltelli offrono una presa intuitiva e curve dolci, che si integrano al vostro ritmo in cucina, garantendo precisione e durezza ad ogni taglio.

Concebidas para se harmonizarem com todos os seus movimentos, as nossas facas oferecem uma pega intuitiva e curvas suaves que complementam o seu ritmo na cozinha, garantindo precisão e durabilidade em cada corte.



Acero Inoxidable NITRUM®

NITRUM® Stainless steel · Acier Inoxydable NITRUM® · Acciaio Inossidabile NITRUM® · Aço Inoxidável NITRUM®.





Remaches de Acero Inox

Stainless Steel Rivets · Rivets en Acier Inoxydable · Rivetti in Acciaio Inossidabile · Rebites de Aço Inoxidável.



Plásticos Técnicos (PP)

Technical Plastics (Polipropileno) · Plastiques Techniques (Polypropylene) · Plastiche Tecniche (Polypropylène) · Plásticos Técnicos (Polipropilene).

 	<p>Blister</p> <p>Acero Inoxidable NITRUM® Polipropileno (PP)</p>	<p>Blister</p> <p>NITRUM® Stainless Steel Polypropylene (PP)</p>	<p>Blister</p> <p>Acier Inoxydable NITRUM® Polypropylène (PP)</p>	<p>Blister</p> <p>Acciaio Inossidabile NITRUM® Polipropilene (PP)</p>	<p>Blister</p> <p>Aço Inoxidável NITRUM® Polipropileno (PP)</p>
---	---	--	---	---	---



150200

80mm/3"
188mm/7,4"

Mondador // Paring Knife
C. Office // Spelucchino
Descascador



150300

100mm/4"
204mm/8"

Mondador // Paring Knife
C. Office // Spelucchino
Descascador



150500

105mm/4"
209mm/8,2"

Mondador // Paring Knife
C. Office // Spelucchino
Descascador



150700

150mm/6"
253mm/9,9"

Cocina // Kitchen Knife
C. À Découper // Coltello Cucina
Cozinha



150800

180mm/7"
301mm/11,8"

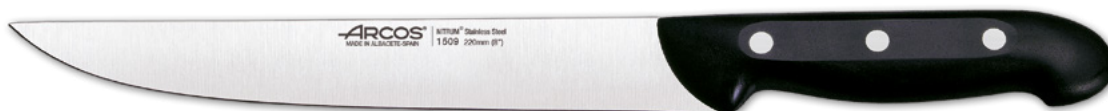

Cocina // Kitchen Knife
C. À Découper // Coltello Cucina
Cozinha



150900

220mm/8"
343mm/13,5"

Trinchante // Carving knife
C. Tranchelard // Coltello Trinciante
Trinchante

	Blister	Blister	Blister	Blister	Blister
	Acero Inoxidable NITRUM® Polipropileno (PP)	NITRUM® Stainless Steel Polypropylene (PP)	Acier Inoxydable NITRUM® Polypropylène (PP)	Acciaio Inossidabile NITRUM® Polipropilene (PP)	Aço Inoxidável NITRUM® Polipropileno (PP)



151500

 160mm/6"
277mm/10,9"

Deshuesador // Boning Knife
C. À Désosser // Coltello Disosso
Para Desossar



151600

 170mm/7"
288mm/11,3"

Santoku (Con Alveolos)
Santoku Knife (Granton Edge)
C. Santoku (Alvéolé) // Coltello
Santoku (Con Alveole) // Santoku
(com Alveolos)

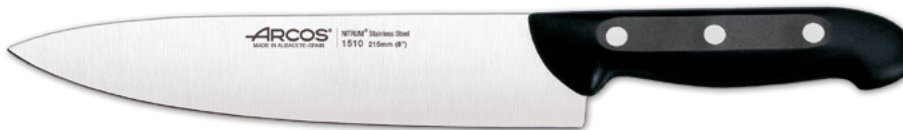

151000

 215mm/8"
335mm/13,1"

Cocinero // Chef's Knife
C. Cuisine // Coltello Cucina
Cozinheiro



151400

 210mm/8"
336mm/13,2"



Panero (Perlado) // Bread Knife
(Serrated) // C. Pain (Cranté)
Coltello Pane (Seghettato) // Para
Pão (Perolado)



151200

 275mm/11"
408mm/16"

Jamoner (Flexible) // Slicing Knife
(Flexible) // C. Jambon (Flexible)
Coltello Prosciutto (Flessibile)
Para Presunto (Flexível)

	Estuche	Case	Étui	Astuccio	Estojo
	Acero Inoxidable NITRUM® Polipropileno (PP)	NITRUM® Stainless Steel Polypropylene (PP)	Acier Inoxydable NITRUM® Polypropylène (PP)	Acciaio Inossidabile NITRUM® Polipropilene (PP)	Aço Inoxidável NITRUM® Polipropileno (PP)





7821

1512



151900

Juego 2 pzas. // 2 pc. Set
Ensemble 2 Pièces // Set 2 Pezzi
Conjunto 2 Peças

	Estuche	Case	Étui	Astuccio	Estojo
	Acero Inoxidable NITRUM® Polipropileno (PP)	NITRUM® Stainless Steel Polypropylene (PP)	Acier Inoxydable NITRUM® Polypropylène (PP)	Acciaio Inossidabile NITRUM® Polipropilene (PP)	Aço Inoxidável NITRUM® Polipropileno (PP)



1505

1507



1510

1856



152600

Set 4 piezas // 4 pc. Set
Set 4 Pièces // Set 4 Pezzi
Conjunto 4 Peças

	Caja Regalo	Gift Box	Boîte Cadeau	Scatola Regalo	Caixa de Presente
	Acero Inoxidable NITRUM® Polipropileno (PP)	NITRUM® Stainless Steel Polypropylene (PP)	Acier Inoxydable NITRUM® Polypropylène (PP)	Acciaio Inossidabile NITRUM® Polipropilene (PP)	Aço Inoxidável NITRUM® Polipropileno (PP)
	Madera de Pino	Pine Wood	Bois de Pin	Legno di Pino	Madeira de Pinho



1502 1507 1510 1514 2784



152000

Juego 5 piezas // 5 pc. Set
Bloc 5 Pièces // Ceppo 5 Pezzi
Conjunto 5 Peças



1856 1505 1510 1514 1512



152100

Juego 5 piezas // 5 pc. Set
Bloc 5 Pièces // Ceppo 5 Pezzi
Conjunto 5 Peças



SERIE NIZA

Sencillez y eficacia se unen en la serie Niza, ideal para el uso diario. Sus materiales de fabricación garantizan un rendimiento duradero y fiable en la rutina de cualquier cocina.

Simplicity and efficiency come together in the Niza series, ideal for daily use. The materials used to make them guarantee a reliable and long-lasting performance in the routine of any kitchen.

Simplicité et efficacité se conjuguent dans la série Niza, idéale à utiliser au quotidien. Ses matériaux de fabrication garantissent des performances durables et fiables jour après jour dans toutes les cuisines.

Semplicità ed efficienza si uniscono nella serie Niza, ideale per l'uso quotidiano. I materiali con cui è fabbricata garantiscono una resa durevole e affidabile nella routine di ogni cucina.

A simplicidade e a eficácia estão reunidas na série Niza, ideal para o uso quotidiano. Os seus materiais de fabrico garantem um desempenho duradouro e fiável em qualquer rotina de cozinha.



Acero Inoxidable NITRUM®

NITRUM® Stainless Steel · Acier Inoxydable NITRUM® · Acciaio Inossidabile NITRUM® · Aço Inoxidável NITRUM®.

Inyección



Inyección · Injection · Iniezione · Invecção.

Plásticos Técnicos (PP)

Technical Plastics (Polipropileno) · Plastiques Techniques (Polypropylene) · Plastiche Tecniche (Polypropylène) · Plásticos Técnicos (Polipropilene).

Resistente Altas Temperaturas

High-Temperature Resistant · Résistant Aux Hautes Températures · Resistente Alle Alte Temperature · Resistente a Altas Temperaturas.

	Blister Cartón	Blister Cardboard	Blister en Carton	Blister di Cartone	Blister de Cartão
	Acero Inoxidable Nitrum® Polipropileno (PP)	NITRUM® Stainless Steel Polypropylene (PP)	Acier Inoxydable NITRUM® Polypropylène (PP)	Acciaio Inossidabile NITRUM® Polipropilene (PP)	Aço Inoxidável Nitrum® Polipropileno (PP)



135000



Mondador // Paring Knife
C. Office // Spelucchino
Descascador



135200



Verduras // Vegetable Knife
C. Office // Coltello Verdura
Legumes



135300



Cocina // Kitchen Knife
C. À Découper // Coltello Cucina
Cozinha



135400





Cocina // Kitchen Knife
C. À Découper // Coltello Cucina
Cozinha

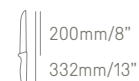

135800



Cocinero // Chef's Knife
C. Cuisine // Coltello Cucina
Cozinheiro

	Blister Cartón	Blister Cardboard	Blister en Carton	Blister di Cartone	Blister de Cartão
	Acero Inoxidable NITRUM® Polipropileno (PP)	NITRUM® Stainless Steel Polypropylene (PP)	Acier Inoxydable NITRUM® Polypropylène (PP)	Acciaio Inossidabile NITRUM® Polipropilene (PP)	Aço Inoxidável NITRUM® Polipropileno (PP)

135500



180mm/7"
314mm/12,3"

Santoku (Con Alveolos)
Santoku Knife (Granton Edge)
C. Santoku (Alvéolé) // Coltello
Santoku (Con Alveole) // Santoku
(com Alveolos)

135700



200mm/8"
330mm/12,9"



Panero (Perlado) // Bread Knife
(Serrated) // C. Pain (Cranté)
Coltello Pane (Seghettato) // Para
Pão (Perolado)

135600



240mm/9"
380mm/14,9"

Jamonero (Flexible) // Slicing Knife
(Flexible) // C. Jambon (Flexible)
Coltello Prosciutto (Flessibile)
Para Presunto (Flexível)

	Display	Display	Carte	Display	Display
	Acero Inoxidable NITRUM® Polipropileno (PP)	NITRUM® Stainless Steel Polypropylene (PP)	Acier Inoxydable NITRUM® Polypropylène (PP)	Acciaio Inossidabile NITRUM® Polipropilene (PP)	Aço Inoxidável NITRUM® Polipropileno (PP)

136700



Juego 2 pzas. // 2 pc. Set
Ensemble 2 Pièces // Set 2 Pezzi
Conjunto 2 Peças



8218

1356



	Display	Display	Carte	Display	Display
	Acero Inoxidable NITRUM® Polipropileno (PP)	NITRUM® Stainless Steel Polypropylene (PP)	Acier Inoxydable NITRUM® Polypropylène (PP)	Acciaio Inossidabile NITRUM® Polipropilene (PP)	Aço Inoxidável NITRUM® Polipropileno (PP)



134900

 130mm/5"
 263mm/10,3"

Multiusos (Perlado)
Multi-Purpose Knife (Serrated)
C. Multi-Usages (Cranté)
Coltello Multiuso (Seghettato)
Faca Multiuso Curva (Perlado)





136500

Set 6 Piezas // 6 pc. Set
Set 6 Ctx. // Set 6 Pezzi
Conjunto 6 Peças



6 X 1352

	Caja Regalo	Gift Box	Boîte Cadeau	Scatola Regalo	Caixa de Presente
	Acero Inoxidable NITRUM® Polipropileno (PP)	NITRUM® Stainless Steel Polypropylene (PP)	Acier Inoxydable NITRUM® Polypropylène (PP)	Acciaio Inossidabile NITRUM® Polipropilene (PP)	Aço Inoxidável NITRUM® Polipropileno (PP)
	Madera de Caucho	Rubber Wood	Bois de Caoutchouc	Legno di Caucciù	Madeira de Borracha



1856

1352

1354

1357

1358

1356



136100

Juego 6 piezas // 6 pc. Set
Bloc 6 Pièces // Ceppo 6 Pezzi
Conjunto 6 Peças



SERIE LÍNEA

¡Potencia la precisión en cada corte! Con su diseño innovador y filo micro dentado lograrás cortes precisos y perfectos en todo tipo de alimentos desde carnes, pescados y pan hasta frutas y verduras.

Enhance the precision in each cut! With its innovative design and micro-serrated edge you will get perfectly precise cuts in all types of food from meat, fish, bread to fruit and vegetables.

Renforcez votre précision à chaque découpe ! Avec son design innovant et son tranchant microdenté, vous obtiendrez des coupes précises et parfaites avec tous types d'aliments, que ce soit de la viande, du poisson, du pain, des fruits ou des légumes.

Potenzia la precisione ad ogni taglio! Grazie al suo design innovatore e al filo micro-dentato otterrete tagli precisi e perfetti per ogni tipo di alimento, dalle carni, al pesce, al pane e persino a frutta e verdura.

Potencie a precisão em cada corte! Com o seu design inovador e o seu fio micro serrilhado, conseguirá cortes precisos e perfeitos em todos os tipos de alimentos, desde carne, peixe e pão a frutas e legumes.



Acero Inoxidable NITRUM®

NITRUM® Stainless steel · Acier Inoxydable NITRUM® · Acciaio Inossidabile NITRUM® · Aço Inoxidável NITRUM®.

Siempre Afilado

Forever Sharp · Toujours Tranchant · Sempre Affilato
Sempre Afiado.



Microperlado

Micro-Serrated · Micro-Cranté · Micro-Seghettato
Micro-Perolado.

Brillo Espejo

Mirror Finish · Finition Miroir · Lucentezza Specchio · Brilho Espelho.





Doble Inyección

Double Injection · Double Injection · Doppia Iniezione
Injecção Dupla



Plásticos Técnicos (PP)

Technical Plastics (Polipropileno) · Plastiques Techniques (Polypropylene) · Plastiche Tecniche (Polypropylène) · Plásticos Técnicos (Polipropilene).

	Blister Cartón	Blister Cardboard	Blister en Carton	Blister di Cartone	Blister de Cartão
	Acero Inoxidable NITRUM® Polipropileno (PP)	NITRUM® Stainless Steel Polypropylene (PP)	Acier Inoxydable NITRUM® Polypropylène (PP)	Acciaio Inossidabile NITRUM® Polipropilene (PP)	Aço Inoxidável NITRUM® Polipropileno (PP)

NEW



379300

 100mm/3,9"
 228mm/8,9"

Mondador (Perlado)
Paring Knife (Micro-Pearl)
C. Office (Microperlé)
Spelucchino (Microperlato)
Descascador (Microperlato)

NEW



379400

 140mm/5,5"
 299mm/11,7"

Cocina (Microperlado)
Kitchen Knife (Micro-Pearl)
C. Multiusaje (Microperlé)
Coltello Cucina (Microperlato)
Cozinha (Microperolado)



NEW



379500

 180mm/7"
 343mm/13,5"

Cocina (Microperlado)
Kitchen Knife (Micro-Pearl)
C. Multiusaje (Microperlé)
Coltello Cucina (Microperlato)
Cozinha (Microperolado)

	Caja Expositora	Display Box	Boîte Présentoir	Scatola Expo	Caixa expositora
	Acero Inoxidable NITRUM® Polipropileno (PP)	NITRUM® Stainless Steel Polypropylene (PP)	Acier Inoxydable NITRUM® Polypropylène (PP)	Acciaio Inossidabile NITRUM® Polipropilene (PP)	Aço Inoxidável NITRUM® Polipropileno (PP)

373624



 100mm/3,9"
 215mm/8,4"



Cuchillo Mesa (Microperlado)
Table Knife (Micro-Pearl)
Couteau Table (Microperlé)
Coltello Tavola (Microperlato)
Faca Mesa (Microperolado)

373631



 100mm/3,9"
 215mm/8,4"

Cuchillo Mesa (Microperlado)
Table Knife (Micro-Pearl)
Couteau Table (Microperlé)
Coltello Tavola (Microperlato)
Faca Mesa (Microperolado)



	Caja Expositora	Display Box	Boîte Présentoir	Scatola S.Expo	Caixa Expositora
	Acero Inoxidable Nitrum® Polipropileno (PP)	NITRUM® Stainless Steel Polypropylene (PP)	Acier Inoxydable NITRUM® Polypropylène (PP)	Acciaio Inossidabile NITRUM® Polipropilene (PP)	Aço Inoxidável NITRUM® Polipropileno (PP)



373632

100mm/3,9"
215mm/8,4"

Cuchillo Mesa (Microperlado)
Table Knife (Micro-Pearl)
Couteau Table (Microperlé)
Coltello Tavola (Microperlato)
Faca Mesa (Microperolado)

	Caja Expositora	Display Box	Boîte Présentoir	Scatola S.Expo	Caixa expositora
	Acero Inoxidable NITRUM® Polipropileno (PP)	NITRUM® Stainless Steel Polypropylene (PP)	Acier Inoxydable NITRUM® Polypropylène (PP)	Acciaio Inossidabile NITRUM® Polipropilene (PP)	Aço Inoxidável NITRUM® Polipropileno (PP)





NEW

373424

150mm/5,9"
265mm/10,4"

Cuchillo Mesa (Microperlado)
Table Knife (Micro-Pearl)
Couteau Table (Microperlé)
Coltello Tavola (Microperlato)
Faca Mesa (Microperolado)

	Estuche	Case	Étui	Astuccio	Estojo
	Acero Inoxidable NITRUM® Polipropileno (PP)	NITRUM® Stainless Steel Polypropylene (PP)	Acier Inoxydable NITRUM® Polypropylène (PP)	Acciaio Inossidabile NITRUM® Polipropilene (PP)	Aço Inoxidável NITRUM® Polipropileno (PP)

849300

Set 2 Piezas //2 pc. Set
Set 2 Ctx. // Set 2 Pezzi
Conjunto 2 Peças



2X 373624



NEW



SERIE LATINA

Realza la cotidianidad con mangos de madera que evocan tradición, ofreciendo sencillez y una elegancia atemporal, ideal para el día a día del cocinero apasionado por lo auténtico.

Everyday life is enhanced with the wooden handles that evoke tradition, providing simplicity and a classic elegance, ideal for daily use for cooks who are passionate about authenticity.

Sublimez le quotidien avec des manches en bois qui évoquent la tradition, offrant simplicité et élégance intemporelle, idéale pour le quotidien des cuisiniers passionnés d'authenticité.

Risalta la consuetudine grazie a manici di legno che richiamano la tradizione ed offrono semplicità e un'eleganza atemporale, ideale per la vita quotidiana del cuoco appassionato dell'autenticità.

Valoriza o quotidiano com cabos de madeira que evocam a tradição, oferecendo simplicidade e elegância intemporal, ideal para o cozinheiro cotidiano com uma paixão pela autenticidade.



Acero Inoxidable NITRUM®

NITRUM® Stainless Steel · Acier Inoxydable NITRUM® · Acciaio Inossidabile NITRUM® · Aço Inoxidável NITRUM®.



Remaches de Acero Inox

Stainless Steel Rivets · Rivets en Acier Inoxydable · Rivetti in Acciaio Inossidabile · Rebites de Aço Inoxidável.



Madera Comprimida

Pack Wood · Bois Compressé · Legno Compresso · Madeira Comprimida.

Diseño Clásico

Classic Design · Design Classique · Design Classico · Design Clássico.

 Caja 100101, 102701, 102501, 100401, 100501 Blister	100100, 102700, 102500, 100400, 100500	100100, 102700, 102500, 100400, 100500	100100, 102700, 102500, 100400, 100500	100100, 102700, 102500, 100400, 100500	100100, 102700, 102500, 100400, 100500
	Acero Inoxidable NITRUM® Madera Comprimida	NITRUM® Stainless Steel Pack Wood	Acier Inoxydable NITRUM® Bois Compressé	Acciaio Inossidabile NITRUM® Legno Compresso	Aço Inoxidável NITRUM® Madeira Comprimida



100100/100101

 65mm/2"
 160mm/6,2"

Mondador // Paring Knife
 C. Office // Spelucchino
 Descascador



102700/102701

 90mm/3"
 182mm/7,1"

Mantequilla (Perlado) // Butter Knife (Serrated) // C. Beurre (Cranté) // Coltello burro (Seghettato) // Manteiga (Perolado)



102500/102501

 105mm/4"
 200mm/7,8"

Cuchillo Queso (Perlado) // Cheese Knife (Serrated) // C. Fromage (Cranté) // Coltello Formaggio (Seghettato) // Queijo (Perolado)



100400/100401

 105mm/4"
 198mm/7,7"

Chuletero (Perlado) // Steak Knife (Serrated) // C. Steak (Cranté) // Coltello Bistecca (Seghettato) // Para Costoletas (Perolado)



100500/100501

 105mm/4"
 198mm/7,7"

Verduras // Vegetable Knife
 C. Office // Coltello Verdura
 Legumes

 100800, 100600, 100700, 101500, 101300 Caja 100801, 100601, 100701, 101501, 101301 Blister	100800, 100600, 100700, 101500, 101300 Box 100801, 100601, 100701, 101501, 101301 Blister	100800, 100600, 100700, 101500, 101300 Boîte 100801, 100601, 100701, 101501, 101301 Blister	100800, 100600, 100700, 101500, 101300 Scatola 100801, 100601, 100701, 101501, 101301 Blister	100800, 100600, 100700, 101500, 101300 Caixa 100801, 100601, 100701, 101501, 101301 Blister

100800/100801

 130mm/5"
 240mm/9,4"

Cocina (Perlado) // Kitchen Knife (Serrated) // C. À Découper (Cranté) Coltello Cucina (Seghettato) Cozinha (Perolado)



100600/100601

 130mm/5"
 240mm/9,4"

Cocina // Kitchen Knife C. À Découper // Coltello Cucina Cozinha



100700/100701

 155mm/6"
 263mm/10,3"

Cocina // Kitchen Knife C. À Découper // Coltello Cucina Cozinha



101500/101501

 170mm/6"
 278mm/10,9"

Panero (Perlado) // Bread Knife (Serrated) // C. Pain (Cranté) Coltello Pane (Seghettato) // Para Pão (Perolado)



101300/101301

 250mm/10"
 360mm/14,1"

Jamonero (Flexible) // Slicing Knife (Flexible) // C. Jambon (Flexible) Coltello Prosciutto (Flessibile) Para Presunto (Flexível)





SERIE NOVA

Un soplo de frescura y color en tu cocina. Cuchillos ligeros y funcionales. Su corte fino y preciso los hace ideales para pequeñas frutas y verduras, disponibles en una paleta de hasta diez colores distintos.

A breath of fresh air and colour in your kitchen. Light and practical knives. Their fine and precise cuts make them ideal for small fruit and vegetables, available in a palette of up to ten different colours.

Un souffle de fraîcheur et de couleur dans votre cuisine. Des couteaux légers et fonctionnels. Leur coupe fine et précise les rend parfaits pour les petits fruits et légumes, disponibles dans une palette qui regroupe jusqu'à dix couleurs différentes.

Una sferzata di freschezza e colore nella vostra cucina. Coltelli leggeri e funzionali. Il loro taglio fine e preciso li rende ideali per piccoli frutti e verdure, disponibili in una gamma di ben dieci colori diversi.

Um sopro de frescura e cor na sua cozinha. Facas leves e funcionais. O seu corte fino e preciso torna-as ideais para pequenas frutas e legumes, disponíveis numa paleta de até dez cores diferentes.



Acero Inoxidable NITRUM®

NITRUM® Stainless steel · Acier Inoxydable NITRUM® · Acciaio Inossidabile NITRUM® · Aço Inoxidável NITRUM®.



Inyección

Inyección · Injection · Injection · Iniezione · Invecção

Mangos de Colores

Handles of Colors · Manches de Couleurs · Manici Colorati · Cabos de Cores.



Plásticos Técnicos (PP)

Technical Plastics (Polipropileno) · Plastiques Techniques (Polypropylene) · Plastiche Tecniche (Polypropylène) · Plásticos Técnicos (Polipropilene).



Resistente Altas Temperaturas

High-Temperature Resistant · Résistant aux Hautes Températures · Resistente alle Alte Temperature · Resistência a Altas Temperaturas.

	Caja Expositora 188301, 18840, 188501, 188601 Blister	Display Box 188301, 18840, 188501, 188601 Blister	Boîte Présentoir 188301, 18840, 188501, 188601 Blister	Scatola Expo 188301, 18840, 188501, 188601 Blister	Caixa Expositora 188301, 18840, 188501, 188601 Blister
	Acero Inoxidable NITRUM® Polipropileno (PP)	NITRUM® Stainless Steel Polypropylene (PP)	Acier Inoxydable NITRUM® Polypropylène (PP)	Acciaio Inossidabile NITRUM® Polipropilene (PP)	Aço Inoxidável NITRUM® Polipropileno (PP)



● 188321 ● 188322 ● 188323 ● 188325

188300/188301



Mondador // Paring Knife
C. Office // Spelucchino
Descascador



● 188421 ● 188422

188400/188401



Mondador // Paring Knife
C. Office // Spelucchino
Descascador



● 188521 ● 188522 ● 188523 ○ 188524 ● 188525 ● 188528 ● 188576 ● 188577 ● 188578

188500/ 188501



Mondador // Paring Knife
C. Office // Spelucchino
Descascador



188510



Mondador (Perlado) // Paring Knife
Serrated // C. Office (Cranté)
Spelucchino (Seghettato)
Descascador (Perolado)



● 188621 ● 188622 ● 188623 ○ 188624 ● 188625 ● 188628 ● 188631 ● 188632 ● 188633 ● 188634
● 188676 ● 188677 ● 188678

188600/188601



Mondador // Paring Knife
C. Office // Spelucchino
Descascador





● 188611 ● 188612 ● 188613 ○ 188614 ● 188615 ● 188618

188610



Mondador (Perlado) // Paring Knife
Serrated // C. Office (Cranté)
Spelucchino (Seghettato)
Descascador (Perolado)

	Caja Expositora 1887900 Caja	Display Box 1887900 Box	Boîte Présentoir 1887900 Boîte	Scatola Expo 1887900 Scatola	Caixa Expositora 1887900 Caixa
	Acero Inoxidable NITRUM® Polipropileno (PP)	NITRUM® Stainless Steel Polypropylene (PP)	Acier Inoxydable NITRUM® Polypropylène (PP)	Acciaio Inossidabile NITRUM® Polipropilene (PP)	Aço Inoxidável NITRUM® Polipropileno (PP)



188200

 70mm/3"
182mm/7,1"

Mondador // Paring Knife
C. Office // Spelucchino
Descascador



188700

 100mm/4"
215mm/8,4"

Queso (Perlado) // Cheese Knife (Serrated) // C. Fromage (Cranté) Coltello Formaggio (Seghettato) Queijo (Perolado)



188000

 90mm/3"
200mm/7,8"

Mantequilla (Perlado) // Butter Knife (Serrated) // C. Beurre (Cranté) // Coltello burro (Seghettato) // Manteiga (Perolado)



188100

 115mm/4,5"
230mm/9"

Chuletero (Perlado) // Steak Knife (Serrated) // C. Steak (Cranté) Coltello Bistecca (Seghettato) Para Costoletas (Perolado)



188800

 110mm/4"
220mm/8,6"

Cuchillo Mesa (Perlado) // Table Knife (Serrated) // Couteau Table (Cranté) // Coltello Tavola (Seghettato) // Faca Mesa (Perolado)



● 188821 ● 188822 ● 188823 ○ 188824 ● 188825



187900

 95mm/3,7"
205mm/8"

Tenedor Mesa // Table Fork Fourchette Table // Forchetta Tavola // Garfo Mesa

 	<p>Blister</p> <p>Acero Inoxidable NITRUM® Polipropileno (PP)</p>	<p>Blister</p> <p>NITRUM® Stainless Steel Polypropylene (PP)</p>	<p>Blister</p> <p>Acier Inoxydable NITRUM® Polypropylène (PP)</p>	<p>Blister</p> <p>Acciaio Inossidabile NITRUM® Polipropilene (PP)</p>	<p>Blister</p> <p>Aço Inoxidável NITRUM® Polipropileno (PP)</p>
---	---	--	---	---	---

188900

Set 6 piezas // 6 pc. Set
Set 6 pièces // Set 6 Pezzi
Conjunto 6 Peças



6 X 188800



6 X 188100



806100

Set 6 piezas // 6 pc. Set
Set 6 pièces // Set 6 Pezzi
Conjunto 6 Peças



188576



188577





188578



859800

Set 3 piezas // 3 pc. Set
Set 3 pièces // Set 3 Pezzi
Conjunto 3 Peças

 	<p>Caja</p> <p>Acero Inoxidable NITRUM® Polipropileno (PP)</p>	<p>Box</p> <p>NITRUM® Stainless Steel Polypropylene (PP)</p>	<p>Boîte</p> <p>Acier Inoxydable NITRUM® Polypropylène (PP)</p>	<p>Scatola</p> <p>Acciaio Inossidabile NITRUM® Polipropilene (PP)</p>	<p>Caixa</p> <p>Aço Inoxidável NITRUM® Polipropileno (PP)</p>
--	--	--	---	---	---



6 X 188576



6 X 188577





6 X 188578



806200

Set 36 piezas // 36 pc. Set
Set 36 pièces // Set 36 Pezzi
Conjunto 36 Peças

 	Blister Acero Inoxidable NITRUM® Polipropileno (PP)	Blister NITRUM® Stainless Steel Polypropylene (PP)	Blister Acier Inoxydable NITRUM® Polypropylène (PP)	Blister Acciaio Inossidabile NITRUM® Polipropilene (PP)	Blister Aço Inoxidável NITRUM® Polipropileno (PP)
---	---	--	---	---	---

189000

Set 2 Pzas. // 2 Pc Set // Set 2 Ctx.
Set 2 Pezzi // Conjunto 2 Peças



188300 188400



189100

Set 6 Pzas. // 6 Pc Set // Set 6 Ctx.
Set 6 Pezzi // Conjunto 6 Peças



6 X 188600



189421/189422

Set 2 Pzas. // 2 Pc Set // Set 2 Ctx.
Set 2 Pezzi // Conjunto 2 Peças





188321 188621 188322 188622



189421



189422

 	Blister Acero Inoxidable NITRUM® Polipropileno (PP)	Blister NITRUM® Stainless Steel Polypropylene (PP)	Blister Acier Inoxydable NITRUM® Polypropylène (PP)	Blister Acciaio Inossidabile NITRUM® Polipropilene (PP)	Blister Aço Inoxidável NITRUM® Polipropileno (PP)
---	---	--	---	---	---



188300 188600 188610



189500

Set 3 piezas // 3 Pc Set // Set 3 Ctx.
Set 3 Pezzi // Conjunto 3 Peças



188321 188621 188611 188322 188622 188612



189621



189622

189621/189622

Set 3 piezas // 3 Pc Set // Set 3 Ctx.
Set 3 Pezzi // Conjunto 3 Peças





181300 188500 188610



189700

Set 3 piezas // 3 Pc Set // Set 3
Pièces // Set 3 Pezzi // Conjunto
3 Peças

 	<p>Blister Cartón</p> <p>Acero Inoxidable NITRUM® Polipropileno (PP)</p>	<p>Blister</p> <p>NITRUM® Stainless Steel Polypropylene (PP)</p>	<p>Blister</p> <p>Acier Inoxidable NITRUM® Polypropylène (PP)</p>	<p>Blister</p> <p>Acciaio Inossidabile NITRUM® Polipropilene (PP)</p>	<p>Blister</p> <p>Aço Inoxidável NITRUM® Polipropileno (PP)</p>
---	--	--	---	---	---



2 X 188500



NEW

189800

Set 2 piezas // 2 Pc Set // Set 2 Ctx.
Set 2 Pezzi // Conjunto 2 Peças



2 X 188800



NEW

189900

Set 2 piezas // 2 Pc Set // Set 2 Ctx.
Set 2 Pezzi // Conjunto 2 Peças



2 X 188600



NEW

187000

Set 2 piezas // 2 Pc Set // Set 2 Ctx.
Set 2 Pezzi // Conjunto 2 Peças



SERIE KIDS

Cocinar puede ser una manera de jugar, aprender y motivar a desarrollar hábitos alimenticios saludables a los más pequeños de la casa.

Cooking can be great way of playing, learning and encouraging healthy eating habits of the youngest members of the family.

Cuisiner peut être une manière de jouer, d'apprendre et de favoriser le développement d'un ensemble d'habitudes alimentaires saines chez les plus petits de la maison.

Per i più piccoli di casa, cucinare può essere un modo di giocare, imparare e spronarli allo sviluppo di sane abitudini alimentari.

A cozinha pode ser uma forma de brincar, aprender e motivar os membros mais jovens da casa para desenvolver hábitos alimentares saudáveis.



Acero Inoxidable NITRUM®

NITRUM® Stainless steel · Acier Inoxydable NITRUM® · Acciaio Inossidabile NITRUM® · Aço Inoxidável NITRUM®.



Remaches de Acero Inox

Stainless Steel Rivets · Rivets en Acier Inoxydable · Rivetti In Acciaio Inossidabile · Rebites de Aço Inoxidável.



Plásticos Técnicos (POM)

Technical Plastics (POM) · Plastiques Techniques (POM) · Plastiche Tecniche (POM) · Plásticos Técnicos (POM)

Protege de lesiones

Protects from Injuries · Protège des Blessures · Rinforzi Protegge Dalle Lesioni · Protege de Lesões

	Estuche	Case	Étui	Astuccio	Estojo
	Acero Inoxidable NITRUM® Polioximetileno (POM)	NITRUM® Stainless Steel Polyoxymethylene (POM)	Acier Inoxydable NITRUM® Polyoxyméthylène (POM)	Acciaio Inossidabile NITRUM® Polioximetilene (POM)	Aço Inoxidável NITRUM® Polioximetileno (POM)



792921



Cuchillo Niños verde // Children K. Green // Couteau Enfant Vert
Coltello per Bambini Verde // Faca Crianças Verde



SERIE ATLÁNTICO

Un homenaje a la cocina con alma, fusionando la elegancia atemporal de la madera de palisandro con la fuerza del acero NITRUM®, para despertar la calidez en cada creación culinaria.

A tribute to cooking with a soul, merging the timeless elegance of the rosewood with the strength of the NITRUM® steel, to wake up the warmth in each culinary creation.

Un hommage à la cuisine authentique, fusionnant l'élégance intemporelle du bois de rose avec la force de l'acier NITRUM®, pour éveiller la chaleur dans chaque création culinaire.

Un omaggio alla cucina con anima, che unisce l'eleganza senza tempo del legno di palissandro alla forza dell'acciaio NITRUM® per rendere calorosa ogni creazione culinaria.

Uma homenagem à cozinha com alma, fundindo a elegância intemporal do pau-rosa com a força do aço NITRUM®, para despertar o calor em cada criação culinária.



Acero Inoxidable NITRUM®

NITRUM® Stainless Steel · Acier Inoxydable NITRUM® · Acciaio Inossidabile NITRUM® · Aço Inoxidável NITRUM®.



Remaches de Acero Inox

Stainless Steel Rivets · Rivets en Acier Inoxydable · Rivetti in Acciaio Inossidabile · Rebites de Aço Inoxidável.



Bactiproof Silver®

Diseño Clásico

Classic Design · Design Classique · Design Classico Design Clássico.

Madera de Palisandro

Rosewood Palisandre · Bois Palissandre · Legno Palissandro Madeira Jacarandá.

NSF National Sanitary Foundation

	Funda Hoja	Plastic Sheath	Gaine	Coprilama	Capa de Lâmina
	Acero Inoxidable NITRUM® Madera de Palisandro	NITRUM® Stainless Steel Rosewood	Acier Inoxydable NITRUM® Palissandre	Acciaio Inossidabile NITRUM® Legno Palissandro	Aço Inoxidável NITRUM® Madeira de Palissandro



270800



Mondador // Paring Knife
C. Office // Spelucchino
Descascador



263000



Mondador // Paring Knife
C. Office // Spelucchino
Descascador



263100



Verduras // Vegetable Knife
C. Office // Coltello Verdura
Legumes



263200

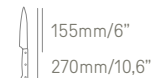

Cocinero // Chef's Knife
C. Cuisine // Coltello Cucina
Cozinheiro



263400

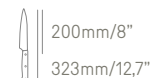

Cocinero // Chef's Knife
C. Cuisine // Coltello Cucina
Cozinheiro



263600

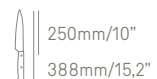

Cocinero // Chef's Knife
C. Cuisine // Coltello Cucina
Cozinheiro

	Funda Hoja	Plastic Sheath	Gaine	Coprilama	Capa de Lâmina
	Acero Inoxidable NITRUM® Madera de Palisandro	NITRUM® Stainless Steel Rosewood	Acier Inoxydable NITRUM® Palissandre	Acciaio Inossidabile NITRUM® Legno Palissandro	Aço Inoxidável NITRUM® Madeira de Palissandro



271300

155mm/6"
288mm/11,3"

Deshuesador // Boning Knife
C. À Désosser // Coltello Disosso
Para Desossar



262400

155mm/6"
264mm/10,3"

Cocina // Kitchen Knife
C. À Découper // Coltello Cucina
Cozinha



260200

170mm/7"
300mm/11,8"

Carnicero // Butcher Knife
C. Boucher // Coltello Macellaio
Carniceiro



260300

200mm/8"
330mm/12,9"

Carnicero // Butcher Knife
C. Boucher // Coltello Macellaio
Carniceiro



260400

250mm/10"
402mm/15,8"

Carnicero // Butcher Knife
C. Boucher // Coltello Macellaio
Carniceiro

	Caja	Box	Boîte	Scatola	Caixa
	Acero Inoxidable NITRUM® Madera de Jatoba	NITRUM® Stainless Steel Jatoba Wood	Acier Inoxydable NITRUM® Jatoba Bois	Acciaio Inossidabile NITRUM® Legno Jatoba	Aço Inoxidável NITRUM® Madeira de Jacarandá



277000

180 mm/7"
306mm/12"

3 mm

≈ 370 gr

Macheta // Cleaver
Couperet // Mannaietta
Machados



SERIE UNIVERSAL PRO

Esencial en la cocina profesional, su diseño ergonómico y la resistencia del acero inoxidable NITRUM® se unen para enfrentar el ritmo intenso y las exigencias del entorno más profesional.

Essential in the professional kitchen, its ergonomic design and the strength of the NITRUM® stainless steel are united to face the intense pace and the demands of the more professional environment.

Indispensable dans la cuisine professionnelle, son design ergonomique et la résistance de l'acier inoxydable NITRUM® se marient pour répondre au rythme intense et aux exigences de l'environnement le plus professionnel.

Indispensabile nella cucina professionale, il suo design ergonomico e la resistenza dell'acciaio inossidabile NITRUM® si uniscono per affrontare il ritmo intenso e le esigenze dell'ambiente più professionale.

Essencial na cozinha profissional, o seu design ergonómico e a resistência do aço inoxidável NITRUM® conjugam-se para enfrentar o ritmo intenso e as exigências do ambiente mais profissional.

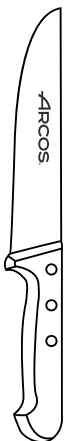

Acero Inoxidable NITRUM®

NITRUM® Stainless Steel · Acier Inoxydable NITRUM®
Acciaio Inossidabile NITRUM® · Aço Inoxidável NITRUM®.



Bactiproof Silver®



Remaches de Acero Inox

Stainless Steel Rivets · Rivets en Acier Inoxydable
Rivetti in Acciaio Inossidabile · Rebites de Aço Inoxidável



Plásticos Técnicos (POM)

Technical Plastics (POM) · Plastiques Techniques (POM) · Plastiche Tecniche (POM)
Plásticos Técnicos (POM).



Resistente Altas Temperaturas

High-Temperature Resistant · Résistant aux Hautes Températures · Resistente alle Alte Temperature
Resistência a altas temperaturas.

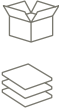

National Sanitary Foundation

	Caja Acero Inoxidable NITRUM® Polioximetileno (POM)	Box NITRUM® Stainless Steel Polyoxymethylene (POM)	Boîte Acier Inoxydable NITRUM® Polyoxyméthylène (POM)	Scatola Acciaio Inossidabile NITRUM® Polioximetileno (POM)	Caixa Aço Inoxidável NITRUM® Polioximetileno (POM)
---	---	--	---	--	--

282904



 150mm/6"
276mm/10,8"

Carnicero // Butcher Knife
C. Boucher // Coltello Scannare
Carniceiro

283004



 175mm/7"
300mm/11,8"

Carnicero // Butcher Knife
C. Boucher // Coltello Scannare
Carniceiro

283104



 200mm/8"
336mm/13,2"

Carnicero // Butcher Knife
C. Boucher // Coltello Scannare
Carniceiro

283204



 250mm/10"
382mm/15"

Carnicero // Butcher Knife
C. Boucher // Coltello Scannare
Carniceiro

283304





 300mm/12"
434mm/17"

Carnicero // Butcher Knife
C. Boucher // Coltello Scannare
Carniceiro

286700



 275mm/11"
399mm/15,7"
 4mm
 ≈ 645gr

Carnicero // Butcher Knife
C. Boucher // Coltello Scannare
Carniceiro

286800



 300mm/12"
426mm/16,7"
 4mm
 ≈ 717gr

Carnicero // Butcher Knife
C. Boucher // Coltello Scannare
Carniceiro

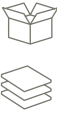
	<p>Caja</p> <p>Acero Inoxidable NITRUM® Polioximetileno (POM)</p>	<p>Box</p> <p>NITRUM® Stainless Steel Polyoxymethylene (POM)</p>	<p>Boîte</p> <p>Acier Inoxydable NITRUM® Polyoxyméthylène (POM)</p>	<p>Scatola</p> <p>Acciaio Inossidabile NITRUM® Polioxyetilene (POM)</p>	<p>Caixa</p> <p>Aço Inoxidável NITRUM® Polioximetileno (POM)</p>
---	---	--	---	---	--



287100

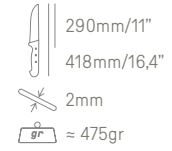

Pescadero // Fishmonger Knife
C. Poisson // Coltello da Pesce
Para Peixe



287000

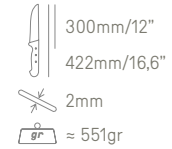

Pescadero // Fishmonger Knife
C. Poisson // Coltello da Pesce
Para Peixe



287200

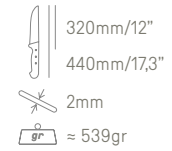

Pescadero // Fishmonger Knife
C. Poisson // Coltello da Pesce
Para Peixe



287800

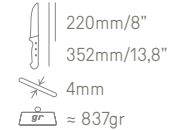

Hachuela // Cleaver // Feuille
Mannaietta // Machados



287900



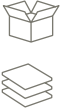

Hachuela // Cleaver // Feuille
Mannaietta // Machados

	Caja Acero Inoxidable NITRUM® Polioximetileno (POM)	Box NITRUM® Stainless Steel Polyoxymethylene (POM)	Boîte Acier Inoxydable NITRUM® Polyoxyméthylène (POM)	Scatola Acciaio Inossidabile NITRUM® Polioximetilene (POM)	Caixa Aço Inoxidável NITRUM® Polioxiimetileno (POM)
---	---	--	---	--	---





2879000

 270mm/10,6"
398mm/15,6"
 4mm
 ≈ 1750gr

**Hachuela // Cleaver // Feuille
Mannaïetta // Machados**





287300

 260mm/10"
386mm/15,1"
 2mm
 ≈ 570gr

**Filetera // Steak Cleaver
Couperet à Filet // Sfilettare
Filetagem**





2873000

 260mm/10"
386mm/15,1"
 3mm
 ≈ 620gr



**Filetera // Steak Cleaver
Couperet à Filet // Sfilettare
Filetagem**



287400

 280mm/11"
407mm/16"
 2mm
 ≈ 700gr

**Filetera // Steak Cleaver
Couperet à Filet // Sfilettare
Filetagem**

	Caja	Box	Boîte	Scatola	Caixa
	Acero Inoxidable NITRUM® Polioximetileno (POM)	NITRUM® Stainless Steel Polyoxymethylene (POM)	Acier Inoxydable NITRUM® Polyoxyméthylène (POM)	Acciaio Inossidabile NITRUM® Polioximetilene (POM)	Aço Inoxidável NITRUM® Polioximetileno (POM)







2875000

 180mm/7"
 312mm/12,1"
 3mm
 ≈ 508gr

Chuletera // Chop Cleaver
Couperet à Côtelette // Bistecca
Para Costoletas



2878000

 220mm/8"
 348mm/13,7"
 3mm
 ≈ 620gr

Chuletera // Chop Cleaver
Couperet à Côtelette // Bistecca
Para Costoletas





2874000

 280mm/11"
 406mm/16"
 3mm
 ≈ 835gr

Chuletera // Chop Cleaver
Couperet à Côtelette // Bistecca
Para Costoletas





790900

 400mm/16"
 656,5mm/25,8"

Corta-Quesos // Cheese Knife
Coupe Fromage // Taglia-
Formaggio // Corta-Queijos





792400

 290mm/11"
 598mm/23,5"

Corta-Quesos // Cheese Knife
Coupe Fromage // Taglia-
Formaggio // Corta-Queijos



792300

 260mm/10"
 526mm/20,7"

Corta-Quesos // Cheese Knife
Coupe Fromage // Taglia-
Formaggio // Corta-Queijos



SERIE COLOUR PROF

Ergonomía y durabilidad, fusionadas para el día a día del mundo industrial. Su acero resiste el paso del tiempo, mientras que su revolucionario mango ergonómico, de polipropileno cubierto en caucho, promete comodidad y adaptabilidad.

Ergonomics and durability, combined for daily use in the industrial world. Its steel withstands the test of time, while its revolutionary ergonomic handle, made of polypropylene covered in rubber, promises comfort and adaptability.

L'alliance parfaite entre ergonomie et durabilité pour une utilisation quotidienne en milieu professionnel. Son acier résiste à l'épreuve du temps, tandis que son manche exceptionnellement ergonomique, en polypropylène, promet confort et adaptabilité.

Ergonomia e durevolezza si fondono per la quotidianità del mondo industriale. Il suo acciaio resiste al trascorrere del tempo, mentre il suo rivoluzionario manico ergonomico in polipropilene rivestito di caucciù garantisce comodità e adattabilità.

Ergonomia e durabilidade, fundidas para o dia a dia do mundo industrial. O seu aço resiste o passar do tempo, enquanto o seu revolucionário cabo ergonómico, em polipropileno revestido a borracha, promete conforto e adaptabilidade.



Acero Inoxidable NITRUM®

NITRUM® Stainless Steel · Acier Inoxydable NITRUM®
Acciaio Inossidabile NITRUM® · Aço Inoxidável NITRUM®.

Bactiproof Silver®

Doble Inyección

Double Injection · Double Injection · Doppia Iniezione
Injeção Dupla.

Resistente Altas Temperaturas

High-Temperature Resistant · Résistant aux Hautes
Températures · Resistente alle Alte Temperature Resistência a
Altas Temperaturas.

Plásticos Técnicos (PP+TPE)

Technical Plastics (Polipropileno + Elastomer) · Plastiques
Techniques (Polypropylene + Élastomère) · Plastiche
Tecniche (Polypropylène + Elastomero) · Plásticos Técnicos
(Polipropilene + Elastômero).

NSF National Sanitary Foundation

ICE PLUS®

Antideslizante

Non-Slip · Antidérapant · Antiscivolo · Antiderrapante.



MANGOS

MANGOS IDENTIFICATIVOS
IDENTIFICATION HANDLES
IDENTIFICATION DES MANCHES
IDENTIFICAZIONE DEI MANICI
CABOS IDENTIFICADORES

IDENTIFICADORES DE COLORES:

El mango de cada cuchillo identifica el tipo de alimentos en el que se va a emplear, mediante el uso de unos tapones de polipropileno de distintos colores se consigue un perfecto control higiénico-sanitario tal como especifican las normas europeas sanitarias de control alimentario.

COLOUR IDENTIFICATION SYSTEM:

Thanks to the colour of the knife handle one can know what type of food to use. This differentiation is made thanks to the polypropylene plugs of different colours which enable a comprehensive hygienic-sanitary control, complying with European hygiene of foodstuffs health regulations.

IDENTIFICATION DES COULEURS:

La couleur du manche du couteau permet de savoir le type d'aliments auxquels il est destiné. Ce type de distinction est possible grâce à des bouchons en Polypropylène de différentes couleurs permettant un contrôle hygiénique-sanitaire exhaustif, conformément aux normes de santé européennes dans le cadre du contrôle alimentaire.

IDENTIFICAZIONE DEI COLORI:

Grazie al colore del manico del coltello, possiamo sapere per quali tipi di alimenti sia indicato. Questa differenziazione è data da dei tappi di Polipropilene di vari colori, che consentono un controllo igienico-sanitario completo, rispettando le norme europee sanitarie di controllo dell'alimentazione.

IDENTIFICADORES DE COR:

A alça de cada faca identifica o tipo de alimento para o qual é destinada, por meio do uso de tampas de polipropileno de cores diferentes, garantindo um controle higiênico-sanitário perfeito, conforme especificado pelas normas europeias de controle de alimentos.

ALIMENTOS COCINADOS

COOKED MEATS
VIANDE CUITE ET
CHACUTERIE
ALIMENTI CUCINATI
ALIMENTOS COZIDOS



CARNE

RAW MEAT
VIANDE CRUE
CRUES CARNE
CARNE



PESCADO

RAW FISH
POISSON CRU
PESCE
PEIXE



FRUTAS Y ENSALADAS

ENSALADAS Y FRUTAS
SALADS AND FRUITS
FRUITS ET SALADES
FRUTTA O MACEDONIE
SALADAS E FRUTAS



VERDURAS

RAW VEGETABLES
LÉGUMES CRUS
VERDURE
VEGETAIS



PASTELERÍA Y LÁCTEOS



BAKERY AND
DAIRY PRODUCTS
LAITAGES PAINS ET
VIENNOISERIES
PANE E PASTICCERIAS
PADARIA E LATICÍNIOS



ALÉRGENOS

ALÉRGENOS
ALLERGENS
ALLERGÈNES
ALLERGENI
ALÉRGENOS



	Funda Display Acero Inoxidable NITRUM®	Display Sleeve NITRUM® Stainless Steel	Carte Acier Inoxydable NITRUM®	Display Acciaio Inossidabile NITRUM®	Capa Expositora Aço Inoxidável NITRUM®
	Polipropileno Recubierto con Elastómero	Polypropylene Covered by Elastomer	Polypropylène Recouvert d'Élastomère	Polipropilene Ricoperto con Elastomero	Polipropileno Revestido a Elastómero

240000

 80mm/3"
191mm/7,5"

Mondador // Paring Knife
C. Office // Spelucchino
Descascador



241300

 100mm/4"
208mm/8,1"

Mondador // Paring Knife
C. Office // Spelucchino
Descascador



243100

 170mm/7"
310mm/12,2"

Lenguado (Flexible) // Sole
Knife (Flexible) // C. Filet de Sole
(Flexible) // Coltello Sogliola
(Flessibile) // Linguado (Flexível)



243200

 190mm/7"
332mm/13"

Fileteador (Semiflexible)
Fillet Knife (Semi-flexible) // C. À
Dénerver (Semi-flexible) // Coltello
Filettare Pesce (Semiflessibile)
Filetar (Semiflexível)



241000

 200mm/8"
330mm/12,9"

Cocinero // Chef's Knife
C. Cuisine // Coltello Cucina
Cozinheiro



241100

 250mm/10"
386mm/15,1"

Cocinero // Chef's Knife
C. Cuisine // Coltello Cucina
Cozinheiro



241200

 300mm/12"
439mm/17,2"

Cocinero // Chef's Knife
C. Cuisine // Coltello Cucina
Cozinheiro

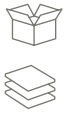

	<p>Funda Display Acero Inoxidable NITRUM®</p> <p>Polipropileno Recubierto con Elastómero</p>	<p>Display Sleeve NITRUM® Stainless Steel</p> <p>Polypropylene Covered by Elastomer</p>	<p>Carte Acier Inoxydable NITRUM®</p> <p>Polypropylène Recouvert d'Élastomère</p>	<p>Display Acciaio Inossidabile NITRUM®</p> <p>Polipropilene Ricoperto con Elastomero</p>	<p>Capa Expositora Aço Inoxidável NITRUM®</p> <p>Polipropileno Revestido a Elastômero</p>
---	--	---	---	---	---



244100

130mm/5"
264mm/10,3"

Carnicero // Sticking Knife
C. Saigner // Coltello Scannare
Carniceiro



243000

150mm/6"
284mm/11,1"

Carnicero // Sticking Knife
C. Saigner // Coltello Scannare
Carniceiro



241400

130mm/5"
265mm/10,4"

Carnicero // Sticking Knife
C. à Découper // Coltello Scannare
Carniceiro



241500

160mm/6"
300mm/11,8"

Carnicero // Sticking Knife
C. à Découper // Coltello Scannare
Carniceiro



241600

180mm/7"
317mm/12,4"



Carnicero // Sticking Knife
C. à Découper // Coltello Scannare
Carniceiro



241700

200mm/8"
329mm/12,9"

Carnicero // Sticking Knife
C. à Découper // Coltello Scannare
Carniceiro

	Funda Display Acero Inoxidable NITRUM®	Display Sleeve NITRUM® Stainless Steel	Carte Acier Inoxydable NITRUM®	Display Acciaio Inossidabile NITRUM®	Capa Expositora Aço Inoxidável NITRUM®
	Polipropileno Recubierto con Elastómero	Polypropylene Covered by Elastomer	Polypropylène Recouvert d'Élastomère	Polipropilene Ricoperto con Elastomero	Polipropileno Revestido com Elastómero



240100

150mm/5"
284mm/11,1"

Carnicero // Butcher Knife
C. Boucher // Coltello Scannare
Carniceiro



240200

180mm/7"
310mm/12,2"

Carnicero // Butcher Knife
C. Boucher // Coltello Scannare
Carniceiro



240300

200mm/8"
334mm/13,1"

Carnicero // Butcher Knife
C. Boucher // Coltello Scannare
Carniceiro



240500

250mm/10"
393mm/15,4"

Carnicero // Butcher Knife
C. Boucher // Coltello Scannare
Carniceiro



240600

300mm/12"
442mm/17,4"

Carnicero // Butcher Knife
C. Boucher // Coltello Scannare
Carniceiro



240700

350mm/14"
490mm/19,2"



Carnicero // Butcher Knife
C. Boucher // Coltello Scannare
Carniceiro



240800

350mm/14"
490mm/19,2"

Pescadero (Perlado) // Fish Knife
(Serrated) // C. Poisson (Cranté)
Coltello Pesce (Seghettato)
Para Peixe (Perlado)

	Funda Display Acero Inoxidable NITRUM®	Display Sleeve NITRUM® Stainless Steel	Carte Acier Inoxydable NITRUM®	Display Acciaio Inossidabile NITRUM®	Capa Expositora Aço Inoxidável NITRUM®
	Polipropileno Recubierto con Elastómero	Polypropylene Covered by Elastomer	Polypropylène Recouvert d'Élastomère	Polipropilene Ricoperto con Elastomero	Polipropileno Revestido a Elastómero



242000

 130mm/6"
275mm/10,8"

Deshuesador // Boning Knife
C. À Désosser // Coltello Disosso
Para Desossar



242200

 140mm/5"
281mm/11"

Deshuesador Curvo // Boning Knife
Curved // C. À Désosser Courbe
// Coltello Disosso Curvo // Para
Desossar Curvo



242100

 150mm/6"
292mm/11,4"

Deshuesador // Boning Knife
C. À Désosser // Coltello Disosso
Para Desossar



242300

 150mm/6"
292mm/11,4"

Deshuesador // Boning Knife
C. À Désosser // Coltello Disosso
Para Desossar



242500

 200mm/8"
333mm/13,1"

Fileteador (Flexible) // Fillet Knife
(Flexible) // C. filets (Flexible)
Coltello Filettare Pesce (Flessibile)
Filetar (Flexível)





245400

 180mm/7"
307mm/12"

Santoku (Con Alveolos)
Santoku Knife (Granton Edge)
C. Santoku (Alvéolé) // Coltello
Santoku (Con Alveole) // Rocking
Santoku (Com Alveolos)



	Funda Display Acero Inoxidable NITRUM®	Display Sleeve NITRUM® Stainless Steel	Carte Acier Inoxydable NITRUM®	Display Acciaio Inossidabile NITRUM®	Capa Expositora Aço Inoxidável NITRUM®
	Polipropileno Recubierto con Elastómero	Polypropylene Covered by Elastomer	Polypropylène Recouvert d'Élastomère	Polipropilene Ricoperto con Elastomero	Polipropileno Revestido A Elastómero



242800

 250mm/10"
380mm/14,9"

Pastelero (Perlado) // Pastry Knife (Serrated) // C. Genoise (Cranté) Coltello Pasticceria-Pane (Seghettato) // Pasteleiro (Perlado)



243500

 300mm/12"
440mm/17,3"

Pastelero (Perlado) // Pastry Knife (Serrated) // C. Genoise (Cranté) Coltello Pasticceria-Pane (Seghettato) // Pasteleiro (Perlado)



242900

 360mm/10"
510mm/20"

Fiambre // Slicing Knife C. Jambon // Coltello Prosciutto Fiambre



242600

 300mm/12"
441mm/17,3"

Jamonero (Flexible) // Slicing Knife (Flexible) // C. Jambon (Flexible) Coltello Prosciutto (Flessibile) Para Presunto (Flexível)



242700

 300mm/12"
441mm/17,3"

Salmón // (Flexible-Con Alveolos) Salmon Knife (Flexible-Granton Edge) // C. Saumon (Flexible-Alvéolé) // Coltello Salmone (Flessibile-Con Alveole) // Salmão (Flexível com Alvéolos)



ARCOS
MADE IN ALBACETE SPAIN

UTRIL® Stainless Steel
2405 250mm (10")





SERIE 2900

Ergonomía que facilita y resistencia que desafía el uso continuo. Esta serie es la elección para quienes valoran la eficiencia y el confort en trabajos exigentes, con la confianza de un control higiénico superior gracias a la diferenciación de cuchillos según el color del mango.

Ergonomics that favours and strength that withstands continual use. This series is the perfect choice for anyone who values efficiency and comfort in demanding jobs, with the reliability of an advanced hygienic control thanks to the colour of the handle that differentiates the knives.

Une ergonomie qui facilite la tâche et une robustesse qui permet une utilisation prolongée. Cette série est le choix de tous ceux qui apprécient l'efficacité et le confort dans les travaux exigeants, avec la confiance d'un contrôle hygiénique supérieur grâce à la différenciation des couteaux en fonction de la couleur de leur manche.

Ergonomia che agevola e resistenza che sfida l'uso continuo. Questa serie è la scelta perfetta per chi apprezza l'efficienza e il comfort nei lavori esigenti, sempre con la sicurezza di un controllo igienico superiore, grazie alla distinzione dei coltelli in base al colore del manico.

Ergonomia que facilita e resistência que desafia o uso contínuo. Esta série é a escolha para quem valoriza a eficácia e o conforto em trabalhos exigentes, com a confiança de um controlo higiénico superior graças à diferenciação das facas pela cor do cabo.



Acero Inoxidable NITRUM®

NITRUM® Stainless Steel · Acier Inoxydable NITRUM®
Acciaio Inossidabile NITRUM® · Aço Inoxidável NITRUM®.

Bactiproof Silver®

Inyección

Inyección · Injection · Iniezione · Injecção

Antideslizante

Non-Slip · Antidérapant · Antiscivolo · Antiderrapante.

Plásticos Técnicos (PP)

Technical Plastics (Polipropileno) · Plastiques Techniques (Polypropylene) · Plastiche Tecniche (Polypropylène) · Plásticos Técnicos (Polipropilene)

Resistente Altas Temperaturas

High-Temperature Resistant · Résistant aux Hautes Températures · Resistente alle Alte Temperature · Resistência a Altas Temperaturas.

NSF National Sanitary Foundation



MANGOS

MANGOS IDENTIFICATIVOS
IDENTIFICATION HANDLES
IDENTIFICATION DES MANCHES
IDENTIFICAZIONE DEI MANICI
CABOS IDENTIFICADORES

IDENTIFICADORES DE COLORES:

El mango de cada cuchillo identifica el tipo de alimentos en el que se debe emplear. Mediante el uso de distintos colores, se consigue un perfecto control higiénico-sanitario tal como especifican las normas europeas sanitarias de control alimentario.

COLOUR IDENTIFICATION:

The handle of each knife identifies the type of food for which the knife must be used. Through the use of various colours, a total hygienic-sanitary control is obtained as specified by the European food safety legislation.

IDENTIFIANTS DE COULEUR:

Le manche de chaque couteau permet l'identification du type d'aliments pour lequel il peut être utilisé. L'utilisation de différentes couleurs permet un contrôle hygiénique et sanitaire parfait, et sanitaire parfait, tel que spécifié par les normes européennes d'hygiène alimentaire.

IDENTIFICATORI DEI COLORI:

Il manico di ogni coltello identifica il tipo di alimenti con i quali si deve utilizzare. Grazie all'utilizzo di diversi colori, si ottiene un perfetto controllo igienico-sanitario, come specificato nelle norme sanitarie europee per il controllo alimentare.

IDENTIFICADORES DE CORES:

A alça de cada faca identifica o tipo de alimentos para os quais deve ser usada. Através do uso de diferentes cores, obtém-se um controle higiênico-sanitário perfeito, conforme especificado pelas normas europeias de controle sanitário de alimentos.

ALIMENTOS COCINADOS

COOKED MEATS
VIANDES CUITES ET
CHARCUTERIES
ALIMENTI CUCINATI
ALIMENTOS COZIDOS



FRUTAS Y ENSALADAS

ENSALADAS Y FRUTAS
SALADS AND FRUITS
FRUITS ET SALADES
FRUTTA O MACEDONIE
SALADAS E FRUTAS



CARNE

RAW MEAT
VIANDES CRUE
CRUES CARNE
CARNE



PESCADO

RAW FISH
POISSONS CRU
PESCE
PEIXE



PASTELERÍA Y LÁCTEOS

BAKERY AND
DAIRY PRODUCTS
LAITAGES PAINS ET
VIENNOISERIES
PANE E PASTICCERIAS
PADARIA E LATICÍNIOS



MULTIUSOS

UTILITY KNIFE
COUTEAUX
MULTIFONCTIONS
MULTIUSOS
MULTIUSO



VERDURAS



RAW VEGETABLES
LÉGUMES CRUS
VERDURE
VEGETAIS



ALÉRGENOS

ALÉRGENOS
ALLERGENS
ALLERGÈNES
ALLERGENI
ALÉRGENOS



	Funda Display	Display Sleeve	Carte	Display	Capa Expositora
	Acero Inoxidable NITRUM® Polipropileno (PP)	NITRUM® Stainless Steel Polypropylene (PP)	Acier Inoxydable NITRUM® Polypropylène (PP)	Acciaio Inossidabile NITRUM® Polipropilene (PP)	Aço Inoxidável NITRUM® Polipropileno (PP)

● 290021 ● 290022 ● 290023 ● 290025 ● 290031



290000

80mm/3"
190mm/7,4"

Mondador // Paring Knife
C. Office // Spelucchino
Descascador

● 290121 ● 290122 ● 290123 ● 290125



290100

100mm/4"
210mm/8,2"

Verduras // Vegetable Knife
C. Office // Coltello Verdura
Legumes

● 294422 ● 294425



294400

130mm/5"
263mm/10,3"

Deshuesador // Boning Knife
C. À Désosser // Coltello Disosso
Para Desosser

● 290421 ● 290422 ● 290423 ● 290425 ● 290431



290400

130mm/5"
260mm/10,2"

Cocina // Kitchen Knife
C. À Découper // Coltello Cucina
Cozinha

● 290521 ● 290522 ● 290523 ● 290525



290500

150mm/6"
271mm/10,6"

Cocina // Kitchen Knife
C. À Découper // Coltello Cucina
Cozinha

● 292121 ● 292122 ● 292123 ● 292124 ● 292125 ● 292128 ● 292131



292100

200mm/8"
332mm/13"

Cocinero // Chef's Knife
C. Cuisine // Coltello Cucina
Cozinheiro



● 292115



292110

200mm/8"
332mm/13"

Cocinero (Perlado) // Chef's Knife (Serrated)
C. Cuisine (Cranté) // Coltello Cucina (Seghettato)
Cozinheiro (Perlado)

	Funda Display	Display Sleeve	Carte	Display	Capa Expositora
	Acero Inoxidable NITRUM® Polipropileno (PP)	NITRUM® Stainless Steel Polypropylene (PP)	Acier Inoxydable NITRUM® Polypropylène (PP)	Acciaio Inossidabile NITRUM® Polipropilene (PP)	Aço Inoxidável NITRUM® Polipropileno (PP)



● 292021 ● 292022 ● 292023 ● 292025

292000



 150mm/6"
 282mm/11,1"

Cocinero // Chef's Knife
C. Cuisine // Coltello Cucina
Cozinheiro



● 290721 ● 290722 ● 290723 ○ 290724 ● 290725 ● 290728

290700

 200mm/8"
 336mm/13,2"

Cocinero (Ancho) // Chef's Knife (Wide) // C. Cuisine (Large)
Coltello Cucina (Largo)
Cozinheiro (Largo)



● 290821 ● 290822 ● 290823 ○ 290824 ● 290825 ● 290828

290800

 250mm/10"
 387mm/15,2"

Cocinero (Ancho) // Chef's Knife (Wide) // C. Cuisine (Large)
Coltello Cucina (Largo)
Cozinheiro (Largo)



● 290921 ● 290922 ● 290923 ● 290925

290900

 300mm/12"
 435mm/17,1"

Cocinero (Ancho) // Chef's Knife (Wide) // C. Cuisine (Large)
Coltello Cucina (Largo)
Cozinheiro (Largo)



● 292221 ● 292222 ● 292223 ○ 292224 ● 292225 ● 292228

292200

 250mm/10"
 383mm/15"

Cocinero // Chef's Knife
C. Cuisine // Coltello Cucina
Cozinheiro



● 292215

292210

 250mm/10"
 383mm/15"

Cocinero (Perlado) // Chef's Knife (Serrated) // C. Cuisine (Cranté)
Coltello Cucina (Seghettato)
Cozinheiro (Perlado)





● 292321 ● 292322 ● 292325

292300

 300mm/12"
 432mm/17"

Cocinero // Chef's Knife
C. Cuisine // Coltello Cucina
Cozinheiro

	Funda Display	Display Sleeve	Carte	Display	Capa Expositora
	Acero Inoxidable NITRUM® Polipropileno (PP)	NITRUM® Stainless Steel Polypropylene (PP)	Acier Inoxydable NITRUM® Polypropylène (PP)	Acciaio Inossidabile NITRUM® Polipropilene (PP)	Aço Inoxidável NITRUM® Polipropileno (PP)

● 292922 ● 292923 ● 292925



292900

 130mm/5"
274mm/10,7"

Carnicero // Butcher Knife
C. Saigner // Coltello Macellaio
Carniceiro

● 293022 ● 293023 ● 293025



293000

 150mm/6"
290mm/11,4"

Carnicero // Butcher Knife
C. Saigner // Coltello Macellaio
Carniceiro

● 294622 ● 294623 ● 294625



294600

 160mm/6"
306mm/12"

Carnicero // Butcher Knife
C. À Découper // Coltello Macellaio
Carniceiro

● 294722 ● 294723 ● 294725



294700

 180mm/7"
323mm/12,7"

Carnicero // Butcher Knife
C. À Découper // Coltello Macellaio
Carniceiro

● 294822 ● 294823 ● 294825



294800

 200mm/8"
336mm/13,2"

Carnicero // Butcher Knife
C. À Découper // Coltello Macellaio
Carniceiro



● 256515



296510

 250mm/10"
400mm/15,7"

Carnicero Curvo // Curved Butcher Knife
C. À Parer Courbe
Coltello Macellaio Curvo
Carniceiro Curvo

	Funda Display	Display Sleeve	Carte	Display	Capa Expositora
	Acero Inoxidable NITRUM® Polipropileno (PP)	NITRUM® Stainless Steel Polypropylene (PP)	Acier Inoxydable NITRUM® Polypropylène (PP)	Acciaio Inossidabile NITRUM® Polipropilene (PP)	Aço Inoxidável NITRUM® Polipropileno (PP)

● 291522 ● 291523 ● 291525



291500



Carnicero // Butcher Knife
C. Boucher // Coltello Macellaio
Carniceiro

● 291622 ● 291623 ● 291625



291600



Carnicero // Butcher Knife
C. Boucher // Coltello Macellaio
Carniceiro

● 291722 ● 291723 ● 291725



291700



Carnicero // Butcher Knife
C. Boucher // Coltello Macellaio
Carniceiro

● 291822 ● 291823 ● 291825



291800



Carnicero // Butcher Knife
C. Boucher // Coltello Macellaio
Carniceiro



● 291922 ● 291923 ● 291925



291900



Carnicero // Butcher Knife
C. Boucher // Coltello Macellaio
Carniceiro

	Funda Display	Display Sleeve	Carte	Display	Capa Expositora
	Acero Inoxidable NITRUM® Polipropileno (PP)	NITRUM® Stainless Steel Polypropylene (PP)	Acier Inoxydable NITRUM® Polypropylène (PP)	Acciaio Inossidabile NITRUM® Polipropilene (PP)	Aço Inoxidável NITRUM® Polipropileno (PP)



● 295822 ● 295823 ● 295825

295800

170mm/7"
305mm/12"

Carnicero (Ancho) // Butcher Knife (Wide) // C. Boucher (Large) Coltello Affettare (Largo) Talhante (Largo)



● 295922 ● 295923 ● 295925

295900

200mm/8"
337mm/13,2"

Carnicero (Ancho) // Butcher Knife (Wide) // C. Boucher (Large) Coltello Affettare (Largo) Talhante (Largo)



● 296022 ● 296023 ● 296025

296000

250mm/10"
384mm/15,11"

Carnicero (Ancho) // Butcher Knife (Wide) // C. Boucher (Large) Coltello Affettare (Largo) Talhante (Largo)



● 292422 ● 292423 ● 292425

292400

350mm/14"
492mm/19,3"

Carnicero // Butcher Knife C. Boucher // Coltello Macellaio Carniceiro





● 292522 ● 292523 ● 292525

292500

350mm/14"
492mm/19,3"

Pescadero (Perlado) // Fish Knife (Serrated) // C. Poisson (Cranté) Coltello Pesce (Seghettato) Para Peixe (Perlado)

	Funda Display	Display Sleeve	Carte	Display	Capa Expositora
	Acero Inoxidable NITRUM® Polipropileno (PP)	NITRUM® Stainless Steel Polypropylene (PP)	Acier Inoxydable NITRUM® Polypropylène (PP)	Acciaio Inossidabile NITRUM® Polipropilene (PP)	Aço Inoxidável NITRUM® Polipropileno (PP)

● 290621 ● 290622 ● 290623 ● 290625



290600



 180mm/7"
 312mm/12,2"

Santoku (Con Alveolos)
Santoku Knife (Granton Edge)
C. Santoku (Alvéolé) // Coltello
Santoku (Con Alveole) // Santoku
(com Alveolos)

● 293123 ● 293125



293100

 170mm/7"
 298mm/11,7"

Lenguado (Flexible) // Sole
Knife (Flexible) // C. Filet de Sole
(Flexible) // Coltello Sogliola
(Flessibile) // Linguado (Flexível)

● 295222 ● 295223 ● 295225



295200

 190mm/7"
 320mm/12,5"

Fileteador (Semiflexible)
Slicing Knife (Semiflexible)
C. À Dénerver (Semiflexible)
Coltello Filettare Pesce
(Semiflessibile) // Filetar
(Semiflexível)

● 295122 ● 295123 ● 295125



295100

 200mm/8"
 330mm/12,9"

Fileteador (Flexible) // Fillet Knife
(Flexible) // C. Filets (Flexible)
(Flexible) // Coltello Filettare Pesce
(Flessibile) // Filetar (Flexível)

● 295522 ● 295525



295500

 250mm/10"
 392mm/15,4"

Trinchante // Carving knife
C. Tranchelard // Coltello Trinciante
Trinchante



● 290325



290300

 180mm/7"
 314mm/12,3"

Tenedor Trinchante // Carving Fork
Fourchette Diapason
Forchettone // Garfo Trinchante

	Funda Display	Display Sleeve	Carte	Display	Capa Expositora
	Acero Inoxidable NITRUM® Polipropileno (PP)	NITRUM® Stainless Steel Polypropylene (PP)	Acier Inoxydable NITRUM® Polypropylène (PP)	Acciaio Inossidabile NITRUM® Polipropilene (PP)	Aço Inoxidável NITRUM® Polipropileno (PP)

● 294225



294200

100mm/4"
243mm/9,5"

Deshuesador // Boning Knife
C. À Désosser // Coltello Disosso
Para Desossar

● 291222 ● 291223 ● 291225



291200

140mm/5"
278mm/10,9"

Deshuesador Curvo (Semiflexible)
Boning Knife Curved (Semi-flexible)
C. À Désosser Courbe (Semi-
flexible) // Coltello Disosso Curvo
(Semiflessibile) // Para Desossar
Curvo (Semiflexível)

● 291322 ● 291323 ● 291325



291300

140mm/5"
278mm/10,9"

Deshuesador Curvo // Boning Knife
Curved // C. À Désosser Courbe
Para Desossar Curvo

● 294022 ● 294025



294000

140mm/5"
273mm/10,7"

Deshuesador // Boning Knife
C. À Désosser // Coltello Disosso
Para Desossar

● 294122 ● 294125



294100

160mm/6"
292mm/11,4"

Deshuesador // Boning Knife
C. À Désosser // Coltello Disosso
Para Desossar



● 294521 ● 294522 ● 294523 ○ 294524 ● 294525



294500

160mm/6"
295mm/11,6"

Deshuesador // Boning Knife
C. À Désosser // Coltello Disosso
Para Desossar

	Funda Display	Display Sleeve	Carte	Display	Capa Expositora
	Acero Inoxidable NITRUM® Polipropileno (PP)	NITRUM® Stainless Steel Polypropylene (PP)	Acier Inoxydable NITRUM® Polypropylène (PP)	Acciaio Inossidabile NITRUM® Polipropilene (PP)	Aço Inoxidável NITRUM® Polipropileno (PP)

● 295322 ● 295323 ● 295325



295300

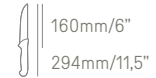

Despellejador // Skinning Knife
C. Dépouiller // Coltello Danese
Esfolar

● 295422 ● 295423 ● 295425



295400



Despellejador // Skinning Knife
C. Dépouiller // Coltello Danese
Esfolar

● 292622 ● 292623 ● 292625



292600



Carnicero // Butcher Knife
C. Boucher // Coltello Macellaio
Carniceiro

● 292721 ● 292722 ● 292723 ● 292725



292700



Carnicero // Butcher Knife
C. Boucher // Coltello Macellaio
Carniceiro



● 292822 ● 292823 ● 292825



292800



Carnicero // Butcher Knife
C. Boucher // Coltello Macellaio
Carniceiro

	Funda Display	Display Sleeve	Carte	Display	Capa Expositora
	Acero Inoxidable NITRUM® Polipropileno (PP)	NITRUM® Stainless Steel Polypropylene (PP)	Acier Inoxydable NITRUM® Polypropylène (PP)	Acciaio Inossidabile NITRUM® Polipropilene (PP)	Aço Inoxidável NITRUM® Polipropileno (PP)

293224 293225



293200



 250mm/10"
 385mm/15,1"

Pastelero (Perlado) // Pastry Knife (Serrated) // C. Genoise (Cranté) Coltello Pasticceria-Panne (Seghettato) // Pasteleiro (Perolado)

295024 295025 295028



295000

 250mm/10"
 395mm/15,5"

Pastelero (Perlado) // Pastry Knife (Serrated) // C. Genoise (Cranté) Coltello Pasticceria-Panne (Seghettato) // Pasteleiro (Perolado)

293724 293725



293700



 300mm/12"
 445mm/17,5"

Pastelero (Perlado Flexible) Pastry Knife (Serrated- Flexible) C. Genoise (Cranté-Flexible) Coltello Pasticceria-Panne (Seghettato-Flessibile) Pasteleiro (Flexível Perolado)

293624 293625



293600



 350mm/14"
 495mm/19,4"

Pastelero (Perlado Flexible) Pastry Knife (Serrated- Flexible) C. Genoise (Cranté-Flexible) Coltello Pasticceria-Panne (Seghettato-Flessibile) Pasteleiro (Flexível Perolado)



291424 291425 291431



291400

 200mm/8"
 320mm/12,5"

Panero (Perlado) // Bread Knife (Serrated) // C. Pain (Cranté) Coltello Pane (Seghettato) // Para Pão (Perolado)

	Funda Display	Display Sleeve	Carte	Display	Capa Expositora
	Acero Inoxidable NITRUM® Polipropileno (PP)	NITRUM® Stainless Steel Polypropylene (PP)	Acier Inoxydable NITRUM® Polypropylène (PP)	Acciaio Inossidabile NITRUM® Polipropilene (PP)	Aço Inoxidável NITRUM® Polipropileno (PP)



● 294922 ○ 294924 ● 294925

294900



250mm/10"
395mm/15,5"

Fiambre // Slicing Knife
C. Jambon // Coltello Prosciutto
Fiambre



● 293422 ● 293425

293400



300mm/12"
445mm/17,5"

Fiambre (Flexible) // Slicing Knife
(Flexible) // C. Jambon (Flexible)
Coltello Prosciutto (Flessibile)
Fiambre (Flexível)



● 293525

293500



350mm/14"
495mm/19,4"

Fiambre (Flexible) // Slicing Knife
(Flexible) // C. Jambon (Flexible)
Coltello Prosciutto (Flessibile)
Fiambre (Flexível)



● 293825

293800



400mm/16"
530mm/20,8"

Fiambre (Flexible) // Slicing Knife
(Flexible) // C. Jambon (Flexible)
Coltello Prosciutto (Flessibile)
Fiambre (Flexível)



● 291125

291100



240mm/9"
360mm/14,1"

Jamonero (Flexible) // Slicing Knife
(Flexible) // C. Jambon (Flexible)
Coltello Prosciutto (Flessibile)
Para Presunto (Flexível)



● 293925

293900

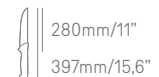

280mm/11"
397mm/15,6"

Jamonero (Flexible) // Slicing Knife
(Flexible) // C. Jambon (Flexible)
Coltello Prosciutto (Flessibile)
Para Presunto (Flexível)



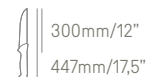

● 293322 ● 293323 ● 293325

293300



300mm/12"
447mm/17,5"

Salmón // (Flexible-Con Alveolos)
Salmon Knife (Flexible-Granton
Edge) // C. Saumon (Flexible-
Alvéolé) // Coltello Salmone
(Flessibile-Con Alveole) // Salmão
(Flexível com Alveolos)

	Funda Display	Display Sleeve	Carte	Display	Capa Expositora
	Acero Inoxidable NITRUM® Polipropileno (PP)	NITRUM® Stainless Steel Polypropylene (PP)	Acier Inoxydable NITRUM® Polypropylène (PP)	Acciaio Inossidabile NITRUM® Polipropilene (PP)	Aço Inoxidável NITRUM® Polipropileno (PP)

● 295725



295700

 300mm/12"
 435mm/17,1"

Salami // Salami Knife
C. Salami // Coltello Salami
Faca Salame



● 298825



298800

 410mm/16"
 545mm/21,4"

Salami // Salami Knife
C. Salami // Coltello Salami
Faca Salame



	Estuche	Case	Étui	Astuccio	Estojo
	Acero Inoxidable NITRUM® Polipropileno (PP)	NITRUM® Stainless Steel Polypropylene (PP)	Acier Inoxydable NITRUM® Polypropylène (PP)	Acciaio Inossidabile NITRUM® Polipropilene (PP)	Aço Inoxidável NITRUM® Polipropileno (PP)



298500





 200mm/8"
 330mm/12,9"
 2,5mm
 ≈ 371gr

Macheta // Cleaver // Couperet
Mannaietta // Machete

	Estuche	Case	Étui	Astuccio	Estojo
	Acero Inoxidable NITRUM® Polipropileno (PP)	NITRUM® Stainless Steel Polypropylene (PP)	Acier Inoxydable NITRUM® Polypropylène (PP)	Acciaio Inossidabile NITRUM® Polipropilene (PP)	Aço Inoxidável NITRUM® Polipropileno (PP)



296100





 190mm/7"
 325mm/12,7"
 4mm
 ≈ 554gr

Hachuela // Cleaver // Feuille
Mannaïetta // Machados

● 296122 ● 296123 ● 296125



296700





 200mm/8"
 330mm/12,9"
 4mm
 ≈ 534gr

Macheta // Cleaver
Couperet // Mannaïetta // Machete

● 296722 ● 296723 ● 296725



297200





 200mm/8"
 338mm/13,3"
 4mm
 ≈ 569gr

Macheta // Cleaver
Couperet // Mannaïetta // Machete

● 297222 ● 297225





297500

 240mm/9"
 375mm/14,7"
 4mm
 ≈ 711gr

Macheta // Cleaver
Couperet // Mannaïetta // Machete

● 297522 ● 297525

	Funda Display	Display Sleeve	Carte	Display	Capa Expositora
	Acero Inoxidable NITRUM® Polipropileno (PP)	NITRUM® Stainless Steel Polypropylene (PP)	Acier Inoxydable NITRUM® Polypropylène (PP)	Acciaio Inossidabile NITRUM® Polipropilene (PP)	Aço Inoxidável NITRUM® Polipropileno (PP)

● 299625



299600

 125x90mm/5x3"
263mm/10,3"

Espátula // Spatula // Spatule
Spatola // Espátula

● 299725



299700

 125x120mm/5x5"
255mm/10"

Espátula // Spatula // Spatule
Spatola // Espátula

● 299525



299500

 155x90mm/6x3"
270mm/10,6"

Espátula // Spatula // Spatule
Spatola // Espátula

ALÉRGENOS

COLOR DE MANGO PARA ALÉRGENOS

COLOURED HANDLE FOR ALLERGENS

UNE COULEUR DE MANCHE POUR SIGNALER LES ALLERGÈNES

COLORE DEL MANICO PER ALLERGENI

COR DO CABO PARA ALÉRGENOS



ARCOS presenta su propuesta de color de mango identificativo apto para el sistema de HACCP, con el fin de hacer la vida más fácil a aquellas personas que tienen algún tipo de alergia alimentaria. Una iniciativa pensada por ARCOS para evitar la contaminación cruzada, algo muy común en nuestras cocinas. Su mango de color fucsia nos indica que al hacer uso del mismo debemos evitar el contacto con otros alimentos alérgenos o superficies en las que anteriormente tocó un alimento que pueda afectar a la salud de la persona alérgica. Con esta propuesta, ARCOS busca concienciar de este problema que afecta a tanta gente y que debemos tener tan presente a la hora de tratar los alimentos.

ARCOS presents its identifying coloured handle design suitable for the HACCP system, so as to make life easier for those persons who suffer from food allergies. An initiative designed by ARCOS in order to avoid cross contamination, something which is very common in our kitchens. Its fuchsia handle shows that when one is using the knife is that contact with other food allergens or surfaces on which food has previously rested on that may affect the health of the allergy sufferer must be avoided. With this concept, ARCOS seeks to raise awareness of this problem which affects so many people and that must borne in mind when it comes to food.

ARCOS présente un nouveau manche dont la couleur sert d'élément d'identification, dans le but de simplifier la vie des personnes souffrant d'une quelconque intolérance alimentaire (gluten, lactose, etc.). Une initiative prise par ARCOS pour éviter la contamination croisée, un phénomène qui se produit très fréquemment dans nos cuisines. Son manche couleur fuchsia nous indique qu'au moment de nous en servir, nous devons éviter tout contact avec d'autres aliments allergènes ou des surfaces ayant été en contact auparavant avec un aliment pouvant nuire à la santé de la personne allergique. Au moyen de cette innovation, ARCOS cherche à mettre en évidence un problème qui concerne de nombreuses personnes et dont nous devons tenir compte au moment de manipuler les aliments. De plus, ce produit satisfait les exigences d'identification HACCP.

ARCOS presenta la sua proposta per il colore che indica il manico adatto per il sistema di HACCP, al fine semplificare la vita alle persone che hanno qualche tipo di allergia alimentare. Un'iniziativa di ARCOS per evitare il contagio incrociato, che è molto comune nelle nostre cucine. Il suo manico color fucsia indica che, utilizzandolo, dobbiamo evitare il contatto con altri alimenti allergeni o con superfici che abbiano precedentemente toccato un alimento che possa danneggiare la salute della persona allergica. Con questa proposta ARCOS cerca di sensibilizzare rispetto a questo problema, che riguarda molte persone e che dobbiamo tenere presente al momento di trattare gli alimenti.

ARCOS apresenta sua proposta de identificação de cor de cabo adequada ao sistema HACCP, com o objetivo de facilitar a vida daqueles que têm alguma alergia alimentar. Uma iniciativa pensada pela ARCOS para evitar a contaminação cruzada, algo muito comum em nossas cozinhas. Seu cabo de cor fúcsia indica que, ao usá-lo, devemos evitar o contato com outros alimentos alergênicos ou superfícies que anteriormente entraram em contato com alimentos que possam afetar a saúde da pessoa alérgica. Com essa proposta, a ARCOS busca conscientizar sobre esse problema que afeta tantas pessoas e que devemos ter em mente ao lidar com alimentos.

PROFESSIONAL POCKET KNIVES
COUTEAUX DE POCHE PROFESIONNELS
LAME PROFESSIONALI
FAÇA PROFISSIONAIS

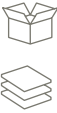

NAVAJAS
PROFESIONALES

	<p>Caja</p> <p>Acero Inoxidable forjado Nitrum® Polipropileno (PP)</p>	<p>Box</p> <p>NITRUM® Stainless Steel Polypropylene (PP)</p>	<p>Boîte</p> <p>Acier Inoxydable NITRUM® Polypropylène (PP)</p>	<p>Scatola</p> <p>Acciaio Inossidabile NITRUM® Polipropilene (PP)</p>	<p>Caixa</p> <p>Aço Inoxidável NITRUM® Polipropileno (PP)</p>
---	--	--	---	---	---



485300



Navaja // Pocket Knife // Couteau
Poche // Coltello Tascabile
Navalha



485329



Navaja // Pocket Knife // Couteau
Poche // Coltello Tascabile
Navalha



485700



Navaja // Pocket Knife // Couteau
Poche // Coltello Tascabile
Navalha



485729



Navaja // Pocket Knife // Couteau
Poche // Coltello Tascabile
Navalha



485900



Navaja // Pocket Knife // Couteau
Poche // Coltello Tascabile
Navalha



485929



Navaja // Pocket Knife // Couteau
Poche // Coltello Tascabile
Navalha

STEAK KNIVES
COUTEAU STEAK
COLTELLI BISTECCA
FACA DE CHURRASCO



CHULETEROS

THE ORIGIN

PÁG 148-151



STEEL-FORCE

PÁG 152-157



FOREST

PÁG 158-167



STEAK BASIC

PÁG 168-175





SERIE THE ORIGIN

El sello de nuestros orígenes en un diseño exclusivo estilo navaja. Elegancia, diseño y funcionalidad en cada pieza. Serie ideal para aportar distinción a cualquier mesa con estilo con un filo liso para cortes precisos.

The hallmark of our origins is an exclusive pocketknife style. Elegance, design and practicality in each piece. Ideal series to add distinction to any table with style, which has a smooth edge for precise cuts.

L'authenticité de nos origines capturée dans un design exclusif, rappelant la forme des couteaux typiquement espagnols. Élégance, conception et fonctionnalité se retrouvent dans chaque pièce. Une collection idéale pour apporter une touche distinctive à toute table, avec un tranchant lisse pour des coupes précises.

La caratteristica delle nostre origini è un design esclusivo, che ricorda il coltello a serramanico. Eleganza, design e funzionalità in ogni pezzo. Serie ideale per donare raffinatezza e stile a ogni tavola, grazie a un filo dritto per tagli precisi.

O selo das nossas origens num design exclusivo ao estilo de navalha. Elegância, design e funcionalidade em cada peça. A série ideal para dar distinção a qualquer mesa elegante, com um fio liso para cortes precisos.

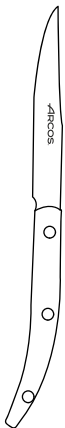

Acero Inoxidable

Stainless Steel · Acier Inoxydable · Acciaio Inossidabile
Aço Inoxidável.



Filo Liso

Smooth Edge · Lame Lisse · Bordo Liscio · Borda Lisa.

Diseño Estilo NAVAJA

Pocketknife-Style Design · Design Style Couteau de Poche · Design Stile Coltello Tascabile · Design Estilo Navalha

Resistente a la Corrosión

Corrosion-Resistant · Résistant à la Corrosion
Resistente alla Corrosione · Resistente à Corrosão.



Remaches de Acero Inox

Stainless Steel Rivets · Rivets en acier inoxydable
Rivetti in Acciaio Inossidabile · Rebites de Aço Inoxidável.

10 Años de Garantía

10-Year Warranty · Garantie 10 Ans · Garanzia 10 Anni
Garantia de 10 Anos.



 	Caja	Box	Boîte	Scatola	Caixa
	Acero Inoxidable NITRUM® Madera Palisandro	NITRUM® Stainless Steel Rosewood	Acier Inoxydable NITRUM® Palissandre	Acciaio Inossidabile NITRUM® Legno Palissandro	Aço Inoxidável NITRUM® Madeira de Palisandro



373700



Chuletero (Filo) // Steak Knife
(Cutting edge) // C. Steak (Lisse)
Coltello Bistecca (Filo) // Faca de
churrasco (Fio)

 	Caja	Box	Boîte	Scatola	Caixa
	Acero Inoxidable NITRUM® MICARTA	NITRUM® Stainless Steel MICARTA	Acier Inoxydable NITRUM® MICARTA	Acciaio Inossidabile NITRUM® MICARTA	Aço Inoxidável NITRUM® MICARTA



373723



Chuletero (Filo) // Steak Knife
(Cutting edge) // C. Steak (Lisse)
Coltello Bistecca (Filo) // Faca de
churrasco (Fio)



373728



Chuletero (Filo) // Steak Knife
(Cutting edge) // C. Steak (Lisse)
Coltello Bistecca (Filo) // Faca de
churrasco (Fio)

 	Caja	Box	Boîte	Scatola	Caixa
	Acero Inoxidable 18/10 Madera Palisandro	Stainless Steel 18/10 Rosewood	Acier Inoxydable 18/10 Palissandre	Acier Inoxydable 18/10 Palissandro	Aço Inoxidável 18/10 Madeira de Palisandro



373900



Tenedor // Steak Fork // Fourchette Table // Forchetta Bistecca Garfo Mesa

 	Caja	Box	Boîte	Scatola	Caixa
	Acero Inoxidable 18/10 MICARTA	Stainless Steel 18/10 MICARTA	Acier Inoxydable 18/10 MICARTA	Acier Inoxydable 18/10 MICARTA	Aço Inoxidável 18/10 MICARTA



373923



Tenedor // Steak Fork // Fourchette Table // Forchetta Bistecca Garfo Mesa



373928

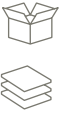

Tenedor // Steak Fork // Fourchette Table // Forchetta Bistecca Garfo Mesa

	Caja	Box	Boîte	Scatola	Caixa
	Acero Inoxidable NITRUM® Madera Palisandro	NITRUM® Stainless Steel Rosewood	Acier Inoxydable NITRUM® Palissandre	Acciaio Inossidabile NITRUM® Legno Palissandro	Aço Inoxidável NITRUM® Madeira de Palissandro



4 X 373700



807000

Set Chuleteros 4 piezas // 4pc. Steak Set
Set Steak 4 pc. // Set Steak 4 Pezzi
Conjunto 4 Peças

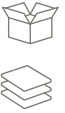
	Caja	Box	Boîte	Scatola	Caixa
	Acero Inoxidable NITRUM® MICARTA	NITRUM® Stainless Steel MICARTA	Acier Inoxydable NITRUM® MICARTA	Acciaio Inossidabile NITRUM® MICARTA	Aço Inoxidável NITRUM® MICARTA



4 X 373723



807100

Set Chuleteros 4 piezas // 4pc. Steak Set
Set Steak 4 pc. // Set Steak 4 Pezzi
Conjunto 4 Peças



4 X 373728



807200

Set Chuleteros 4 piezas // 4pc. Steak Set
Set Steak 4 pc. // Set Steak 4 Pezzi
Conjunto 4 Peças



SERIE STEEL FORCE

Fabricados en una sola pieza de acero inoxidable que ofrecen durabilidad y resistencia a la corrosión. Perfectos para uso diario, robustos, esenciales y duraderos para cualquier mesa.

Made in one single piece of stainless steel that is durable and corrosion-resistant. Perfect for daily use, robust, essential and long-lasting for any table.

Fabriqués d'une seule pièce en acier inoxydable, durables et résistants à la corrosion. Parfaits à utiliser au quotidien, robustes, essentiels et durables pour n'importe quelle table.

Fabbricati in un unico pezzo di acciaio inossidabile, che fornisce durevolezza e resistenza alla corrosione. Perfetti per l'uso quotidiano, robusti, essenziali e durevoli per ogni tavola.

Fabricadas a partir de uma única peça de aço inoxidável para maior durabilidade e resistência à corrosão. Perfeitas para o uso quotidiano, robustas, essenciais e duradouras para qualquer mesa.



Acero Inoxidable

Stainless steel · Acier Inoxydable · Acciaio Inossidabile
Aço Inoxidável.

Fabricados de una Sola Pieza



Made in one Piece · Fabriqués en une Seule Pièce · Fabbricati
in un Unico Pezzo · Fabricados em uma Única Peça.

Resistente a la Corrosión

Corrosion-Resistant · Résistant à la Corrosion · Resistente
alla Corrosione · Resistente à Corrosão.

10 Años de Garantía

10-Year Warranty · Garantie 10 Ans · Garanzia 10 Anni
Garantia de 10 Anos.

	Caja	Box	Boîte	Scatola	Caixa
	Acero Inoxidable	Stainless Steel	Acier Inoxydable	Acciaio Inossidabile	Aço Inoxidável



375500

 110mm/4,3"
220mm/8,6"

Chuletero (Perlado) // Steak Knife (Serrated) // C. Steak (Cranté) // Coltello Bistecca (Seghettato) // Faca de churrasco (Perolado)



375800

 110mm/4,3"
220mm/8,6"

Chuletero (Perlado) // Steak Knife (Serrated) // C. Steak (Cranté) // Coltello Bistecca (Seghettato) // Faca de churrasco (Perolado)



702000

 110mm/4,3"
220mm/8,6"

Chuletero (Perlado) // Steak Knife (Serrated) // C. Steak (Cranté) // Coltello Bistecca (Seghettato) // Faca de churrasco (Perolado)



376500

 110mm/4,3"
220mm/8,6"



Chuletero (Filo) // Steak Knife (Cutting edge) // C. Steak (Lisse) // Coltello Bistecca (Filo) // Faca de churrasco (Fio)



701000

 110mm/4,3"
220mm/8,6"

Chuletero (Filo) // Steak Knife (Cutting edge) // C. Steak (Lisse) // Coltello Bistecca (Filo) // Faca de churrasco (Fio)

	Caja	Box	Boîte	Scatola	Caixa
	Acero Inoxidable	Stainless Steel	Acier Inoxydable	Acciaio Inossidabile	Aço Inoxidável



376900

 110mm/4,3"
230mm/9"

Chuletero (Filo) // Steak Knife (Cutting edge) // C. Steak (Lisse) Coltello Bistecca (Filo) // Faca de churrasco (Fio)



375900

 110mm/4,3"
230mm/9"

Chuletero (Perlado) // Steak Knife (Serrated) // C. Steak (Cranté) Coltello Bistecca (Seghettato) Faca de churrasco (Perolado)



565600

 115mm/4,5"
235mm/9,2"

Chuletero (Perlado) // Steak Knife (Serrated) // C. Steak (Cranté) Coltello Bistecca (Seghettato) Faca de churrasco (Perolado)

	Caja	Box	Boîte	Scatola	Caixa
	Acero Inoxidable 18/10	Stainless Steel 18/10	Acier Inoxydable 18/10	Acciaio Inossidabile 18/10	Aço Inoxidável 18/10



702100

 95mm/4"
200mm/7,8"

Tenedor // Steak Fork // Fourchette Table // Forchetta Bistecca Garfo

	Caja	Box	Boîte	Scatola	Caixa
	Acero Inoxidable 18/10	Stainless Steel 18/10	Acier Inoxydable 18/10	Acciaio Inossidabile 18/10	Aço Inoxidável 18/10



701900

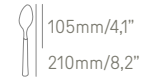



Cuchara // Spoon // Cuillère
Cucchiaione // Colher



701800



Cuchara Lunch // Lunch Spoon
Cuillère Lunch // Cucchiaio Frutta
Colher Lunch

	Caja	Box	Boîte	Scatola	Caixa
	Acero Inoxidable	Stainless Steel	Acier Inoxydable	Acciaio Inossidabile	Aço Inoxidável



4 X 376900



NEW

377900

Set Chuleteros 4 piezas // 4pc. Steak
Set // Set 4 Pièces // Set Steak 4 // Pezzi
Conjunto 4 Peças

	Caja	Box	Boîte	Scatola	Caixa
	Acero Inoxidable	Stainless Steel	Acier Inoxydable	Acciaio Inossidabile	Aço Inoxidável

378000

Set Chuleteros 6 piezas // 6 pc. Steak
Set // Set 6 Ctx steak// Set Steak 6
Pezzi Conjunto 6 Peças



6 X 375500



378100

Set Chuleteros 12 piezas // 12 pc. Steak
Set // Set 12 Steak // Set Steak 12 Pezzi
Conjunto 12 Peças



6 X 3755 6 X 7021



378200

Set Chuleteros 6 piezas // 6 pc. Steak
Set // Set 6 Steak // Set Steak 6 // Pezzi
Conjunto 6 Peças



6 X 376500



378400

Set Chuleteros 4 piezas // 4 pc. Steak
Set // Set 4 Ctx Steak // Set Steak 4
Pezzi Conjunto 4 Peças



4 X 375800



702300

Set Chuleteros 6 piezas // 6 pc. Steak
Set // Set 6 Steak // Set Steak 6 // Pezzi
Conjunto 6 Peças



6 X 702000



377400

Set Chuleteros 4 piezas // 4 pc. Steak
Set Set 4 ctx Steak // Set Steak 4 // Pezzi
Conjunto 4 Peças



4 X 375900





ARCOS

ARCOS
MADE IN ITALY

ARCOS
MADE IN ITALY

ARCOS
MADE IN ITALY

ARCOS
MADE IN ITALY



SERIE FOREST

Un toque rústico y de calidez. ideales para quienes buscan durabilidad y estilo tradicional en el uso diario. Su mango de madera natural agrega un encanto atemporal y funcionalidad a la mesa.

A rustic and warm touch. Ideal for anyone who wants durability and a traditional style in daily use. Its natural wood handle adds a classic charm and practicality to the table.

Une touche rustique et chaleureuse, parfaite pour ceux qui privilégient la durabilité et le style traditionnel au quotidien. Son manche en bois naturel apporte un charme intemporel à la table, combinant élégance et praticité.

Un tocco rustico e caloroso. Ideali per chi ricerca la durevolezza e lo stile tradizionale nell'uso quotidiano. Il manico di legno naturale dona alla tavola un fascino senza tempo e funzionalità.

Um toque de rusticidade e calor, ideais para quem procura durabilidade e estilo tradicional no dia a dia. O cabo em madeira natural confere um charme intemporal e funcionalidade à mesa.

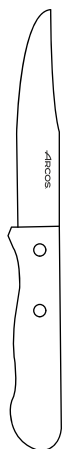

Acero Inoxidable

Stainless Steel · Acier Inoxydable · Acciaio Inossidabile · Aço Inoxidável.

Diseño Rústico

Diseño Rústico · Rustic Design · Design Rustique · Design Rustico · Design Rústico.



MANGO de Madera NATURAL

Natural Wood Handles · Manches en Bois Naturel · Manici in Legno Naturale · Cabos de Madeira Natural.



Remaches de Acero Inox

Stainless Steel Rivets · Rivets en Acier Inoxydable · Rivetti in Acciaio Inossidabile · Rebites de Aço Inoxidável.

10 Años de Garantía

10-Year Warranty · Garantie 10 Ans · Garanzia 10 Anni · Garantia de 10 Anos.

	Caja	Box	Boîte	Scatola	Caixa
	Acero Inoxidable Nitrum® Madera Comprimida	NITRUM® Stainless Steel Pack-Wood	Acier Inoxydable NITRUM® Bois Compressé	Acciaio Inossidabile NITRUM® Legno Compresso	Aço Inoxidável NITRUM® Madeira comprimida



371800



Chuletero Natural (Perlado)
Natural Steak Knife (Serrated)
C. Steak Naturel (Cranté) // Coltello
Bistecca Naturale (Seghettato)
Faca de Churrasco Natural
(Perlado)



371822



Chuletero Natural (Perlado)
Natural Steak Knife (Serrated)
C. Steak Acajou (Cranté) // Coltello
Bistecca Naturale (Seghettato)
Faca de Churrasco Natural
(Perlado)



371823



Chuletero Natural (Perlado)
Natural Steak Knife (Serrated)
C. Steak Bleu-vert (Cranté)
Coltello Bistecca Naturale
(Seghettato) // Faca de Churrasco
Natural (Perlado)

	Caja	Box	Boîte	Scatola	Caixa
	Acero Inoxidable 18/10 Madera Comprimida	Stainless Steel 18/10 Pack-Wood	Acier Inoxydable 18/10 Bois Compressé	Acciaio Inossidabile 18/10 Legno Compresso	Aço Inoxidável 18/10 Madeira comprimida



NEW

371900



**Tenedor // Steak Fork // Fourchette
Table // Forchetta Bistecca
Garfo Mesa**



NEW

372100



**Cuchara Mesa // Table Spoon
Cuillère Table // Cucchiione Tavola
Colher Mesa**



NEW

373000

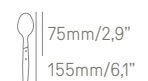

**Cuchara Lunch // Lunch Spoon
Cuillère Lunch // Cucchiaino Frutta
Colher Lunch**

EL VALOR DE NUESTRAS RAÍCES

El cuchillo chuletero modelo 3715 de Arcos simboliza la unión de tradición y calidad. Creado por Gregorio Arcos Villanueva, refleja tanto la herencia artesanal como la innovación en el diseño de cuchillería. Con mangos de madera que proporcionan un tacto natural y una sierra robusta para cortes precisos, el 3715 se distingue por su funcionalidad y elegancia atemporal.

Gregorio, un visionario en la historia de Arcos, aportó técnicas refinadas y un enfoque progresista a la artesanía de cuchillos, asegurando que este modelo no solo cumpliera con las expectativas actuales, sino que también se mantuviera como un ícono de la gastronomía. Su visión se manifiesta en cada línea y curva del 3715, conservando su lugar en la mesa como un verdadero emblema de la excelencia culinaria.

THE VALUE OF OUR ROOTS

The Arcos steak knife model 3715 stands for the union of tradition and quality. Created by Gregorio Arcos Villanueva, it conveys the artisan heritage and the innovation in designing cutlery. With wooden handles that have a natural texture and a strong serrated blade for precise cuts, the 3715 is distinguished for its practicality and timeless elegance.

Gregorio, a visionary in the history of Arcos, came up with sophisticated techniques and a progressive approach to knife making, which guarantees that this model meets modern-day expectations, and is also maintained as a culinary icon. His vision is conveyed in each line and curve of the 3715, preserving its place on the table as a true emblem of culinary excellence.

L'IMPORTANCE DE NOS RACINES

Le couteau à steak Arcos modèle 3715 représente la symbiose de la tradition et de la qualité. Créé par Gregorio Arcos Villanueva, il reflète à la fois l'héritage artisanal et l'innovation dans la conception de la coutellerie. Avec des manches en bois pour un toucher naturel et une denture robuste pour des coupes précises, le modèle 3715 se distingue par sa fonctionnalité et son élégance intemporelle.

Gregorio, visionnaire dans l'histoire d'Arcos, a mis en



œuvre des techniques raffinées et une approche progressive de l'artisanat des couteaux, garantissant que ce modèle non seulement répond aux attentes d'aujourd'hui, mais qu'il reste également tout un symbole de la gastronomie. Sa vision s'exprime dans chaque ligne et dans chaque courbe du modèle 3715, conservant sa place à table comme un véritable signe d'identité de l'excellence culinaire.

IL VALORE DELLE NOSTRE RADICI

Il coltello da bistecca modello 3715 di Arcos simboleggia l'unione di tradizione e qualità. Creato da Gregorio Arcos Villanueva, rispetta sia l'eredità artigianale che l'innovazione nel design dei coltelli. Grazie a manici in legno dal tatto naturale e a una seghettatura robusta, per tagli precisi, il 3715 si contraddistingue per la sua funzionalità ed eleganza senza tempo.

Gregorio, un visionario nella storia di Arcos, apportò tecniche raffinate e un approccio progressista all'artigianato dei coltelli, garantendo così che questo modello non solamente soddisfacesse le aspettative attuali, ma che diventasse anche un'icona della gastronomia. La sua visione si trova in ogni linea e ogni curva del 3715, che conserva il suo posto a tavola come vero emblema dell'eccellenza culinaria.

O VALOR DAS NOSSAS RAÍZES

A faca para bifés modelo 3715 da Arcos simboliza a união da tradição e da qualidade. Criada por Gregorio Arcos Villanueva, reflete uma herança de artesanato e inovação no design de cutelaria. Com cabos de madeira que proporcionam um toque natural e uma serra robusta para cortes precisos, a 3715 distingue-se pela sua funcionalidade e elegância intemporal.

Gregorio, um visionário na história da Arcos, trouxe técnicas refinadas e uma abordagem progressiva ao fabrico de facas, assegurando que este modelo não só satisfazia as expectativas atuais, como também permanecia um ícone da gastronomia. A sua visão manifesta-se em cada linha e curva da 3715, mantendo o seu lugar à mesa como um verdadeiro emblema da excelência culinária.

	Caja 371501 Display	Box 371501 Display	Boîte 371501 Carte	Scatola 371501 Display	Caixa 371501 Display
	Acero Inoxidable NITRUM® Madera Comprimida	NITRUM® Stainless Steel Pack-Wood	Acier Inoxydable NITRUM® Bois Compressé	Acciaio Inossidabile NITRUM® Legno Compresso	Aço Inoxidável NITRUM® Madeira Comprimida



371500/ 371501



Chuletero (Perlado) // Steak Knife (Serrated) // C. Steak (Cranté) Coltello Bistecca (Seghettato) Faca de Churrasco (Perlado)



373200



Chuletero (Filo) // Steak Knife (Cutting edge) // C. Steak (Lisse) Coltello Bistecca (Filo) // Faca de churrasco (Fio)

	Caja 371601 Display	Box 371601 Display	Boîte 371601 Carte	Scatola 371601 Display	Caixa 371601 Display
	Acero Inoxidable 18/10 Madera Comprimida	Stainless Steel 18/10 Pack-Wood	Acier Inoxydable 18/10 Bois Compressé	Acciaio Inossidabile 18/10 Legno Compresso	Aço Inoxidável 18/10 Madeira Comprimida



NEW

371600/371601



Tenedor // Steak Fork // Fourchette Table // Forchetta Bistecca Garfo Mesa



NEW

371700



Cuchara Mesa // Table Spoon Cuillère Table // Cucchiione Tavola Colher Mesa



NEW

371400

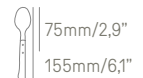

Cuchara Lunch // Lunch Spoon Cuillère Lunch // Cucchião Frutta Colher Lunch

	Caja	Box	Boîte	Scatola	Caixa
	Acero Inoxidable NITRUM® Madera de Haya	NITRUM® Stainless Steel Beech Wood	Acier Inoxydable NITRUM® Bois de Hêtre	Acciaio Inossidabile NITRUM® Legno di Faggio	Aço Inoxidável NITRUM® Madeira de Faia



NEW

374200

 126mm/4,9"
 257mm/10,1"

Cuchillo para Churrasco (Perlado)
Steak Knife (Serrated) // C. Steak
Churrasco (Cranté) // Coltello
Bistecca (Seghettato) // Faca para
Churrasco (Perolado)

	Caja	Box	Boîte	Scatola	Caixa
	Acero Inoxidable NITRUM® Madera Comprimida	NITRUM® Stainless Steel Pack-Wood	Acier Inoxydable NITRUM® Bois Compressé	Acciaio Inossidabile NITRUM® Legno Compresso	Aço Inoxidável NITRUM® Madeira C/Comprimida



372500

 110mm/4,3"
 220mm/8,6"

Chuletero (Perlado) // Steak Knife
(Serrated) // C. Steak (Cranté)
Coltello Bistecca (Seghettato)
Faca de Churrasco (Perolado)



372700

 120mm/4,7"
 235mm/9,2"

Chuletero (Perlado) // Steak Knife
(Serrated) // C. Steak (Cranté)
Coltello Bistecca (Seghettato)
Faca de Churrasco (Perolado)

	Caja	Box	Boîte	Scatola	Caixa
	Acero Inoxidable 18/10 Madera Comprimida	Stainless Steel 18/10 Pack-Wood	Acier Inoxydable 18/10 Bois Compressé	Acciaio Inossidabile 18/10 Legno Compresso	Aço Inoxidável 18/10 Madeira Comprimida



372600

 90mm/3,5"
 250mm/9,8"

Tenedor // Steak Fork // Fourchette
Steak // Forchetta Bistecca
Garfo Mesa

	Caja	Box	Boîte	Scatola	Caixa
	Acero Inoxidable NITRUM® Madera Comprimida	NITRUM® Stainless Steel Pack-Wood	Acier Inoxydable NITRUM® Bois Compressé	Acciaio Inossidabile NITRUM® Legno Compresso	Aço Inoxidável NITRUM® Madeira Comprimida



803800



Chuletero (Perlado) // Steak Knife
(Serrated) // C. Steak (Cranté)
Coltello Bistecca (Seghettato)
Faca de Churrasco (Perlado)

	Caja	Box	Boîte	Scatola	Caixa
	Acero Inoxidable 18/10 Madera Comprimida	Stainless Steel 18/10 Pack-Wood	Acier Inoxydable 18/10 Bois Compressé	Acier Inoxydable 18/10 Legno Compresso	Aço Inoxidável 18/10 Madeira Comprimida



803900



Tenedor // Steak Fork // Fourchette
Table // Forchetta Bistecca
Garfo Mesa



803700

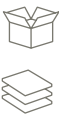

Cuchara Mesa // Table Spoon
Cuillère Table // Cucchiavione Tavola
Colher Mesa

	Caja	Box	Boîte	Scatola	Caixa
	Acero Inoxidable NITRUM® Madera Comprimida	NITRUM® Stainless Steel Pack-Wood	Acier Inoxydable NITRUM® Bois Compressé	Acciaio Inossidabile NITRUM® Legno Compresso	Aço Inoxidável NITRUM® Madeira comprimida



374610

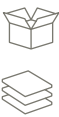

Chuletero-Macheta (filo)
Steak Knife Cleaver (Cutting Edge)
C. à steak-couperet (Lisse)
Coltello Bistecca-Mannaietta
(Filo) // Faca de Churrasco (Fio)

	Caja	Box	Boîte	Scatola	Caixa
	Acero Inoxidable 18/10 Madera Comprimida	Stainless Steel 18/10 Pack-Wood	Acier Inoxydable 18/10 Bois Compressé	Acciaio Inossidabile 18/10 Legno Compresso	Aço Inoxidável 18/10 Madeira comprimida



374710

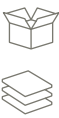

Tenedor // Steak Fork // Fourchette
Table // Forchetta Bistecca
Garfo Mesa

	Blister	Blister	Carte	Blister	Blíster
	Acero Inoxidable NITRUM® Madera Comprimida	NITRUM® Stainless Steel Pack-Wood	Acier Inoxydable NITRUM® Bois Compressé	Acciaio Inossidabile NITRUM® Legno Compresso	Aço Inoxidável NITRUM® Madeira comprimida



6 X 3715



372000

Set Chuleteros 6 piezas // 6 pc. Steak Set
Set 6 Steak Bois // Set Steak 6 Pezzi
Conjunto 6 Peças

 	Caja Regalo	Gift Box	Boîte Cadeau	Scatola Regalo	Caixa de Presente
	Acero Inoxidable NITRUM® Acero Inoxidable 18/10 Madera de Chopu Comprimida	NITRUM® Stainless Steel Acero Inoxidable 18/10 Pack-Wood	Acier Inoxydable NITRUM® Acier Inoxydable 18/10 Bois Compressé	Acciaio Inossidabile NITRUM® Acier Inoxydable 18/10 Legno Compresso	Aço Inoxidável NITRUM® Aço Inoxidável 18/10 Madeira de Choupo Comprimida



377700

Juego Chuleteros 12 piezas // 12 pc. Steak Set // Set 12 pc. Steak // Set Steak 12 Pezzi // Conjunto 12 Peças



6 X 3715 6 X 3716



 	Caja Regalo	Gift Box	Boîte Cadeau	Scatola Regalo	Caixa de Presente
	Acero Inoxidable NITRUM® Acero Inoxidable 18/10 Madera de Chopu Comprimida	NITRUM® Stainless Steel Acero Inoxidable 18/10 Pack-Wood	Acier Inoxydable NITRUM® Acier Inoxydable 18/10 Bois Compressé	Acciaio Inossidabile NITRUM® Acier Inoxydable 18/10 Legno Compresso	Aço Inoxidável NITRUM® Aço Inoxidável 18/10 Madeira de Choupo Comprimida

372200

Set Chuleteros 12 piezas // 12 pc. Steak Set // Set 12 pc. Steak // Set Steak 12 Pezzi // Conjunto 12 Peças



6 X 3718 6 X 3719



	<p>Caja</p> <p>Acero Inoxidable NITRUM® Madera Comprimida</p>	<p>Box</p> <p>NITRUM® Stainless Steel Pack-Wood</p>	<p>Boîte</p> <p>Acier Inoxydable NITRUM® Bois Compressé</p>	<p>Scatola</p> <p>Acciaio Inossidabile NITRUM® Legno Compresso</p>	<p>Caixa</p> <p>Aço Inoxidável NITRUM® Madeira comprimida</p>
---	---	---	---	--	---



6 X 3718



372300

Set Chuleteros 6 piezas // 6 pc. Steak Set // Set 6 C. Steak // Set Steak 6 Pezzi
Conjunto 6 Peças



6 X 371823



830400

Set Chuleteros 6 piezas // 6 pc. Steak Set
Set 6 C. Steak // Set Steak 6 Pezzi
Conjunto 6 Peças



6 X 371822



377100

Set Chuleteros 6 piezas // 6 pc. Steak Set
Set 6 C. Steak // Set Steak 6 Pezzi
Conjunto 6 Peças

 	Caja Acero Inoxidable NITRUM® Madera Comprimida	Box NITRUM® Stainless Steel Pack-Wood	Boîte Acier Inoxydable NITRUM® Bois Compressé	Scatola Acciaio Inossidabile NITRUM® Legno Compresso	Caixa Aço Inoxidável NITRUM® Madeira comprimida
--	---	---	---	--	---



6 X 373200



377000

Set Chuleteros (Filo) 6 piezas // 6 pc.
Steak Set (Cutting edge) // Set 6 C. Steak
Set Steak 6 Pezzi Conjunto 6 Peças (Fio)



6 X 371500



377600

Set Chuleteros (Filo) 6 piezas // 6 pc.
Steak Set (Cutting edge) // Set 6 C. Steak
Set Steak 6 Pezzi Conjunto 6 Peças (Fio)



SERIE STEAK BASIC

Variedad para cada ocasión con diseños que se adaptan a cualquier preferencia, ideales para diferentes estilos de mesa. Con mangos duraderos y resistentes al agua, garantiza un agarre cómodo.

Variety for each occasion with designs that adapt to any preference, ideal for different table styles. With durable and water-resistant handles that guarantee a comfortable grip.

De la variété pour toutes les occasions avec des designs adaptés à toutes les préférences, parfait pour différents styles de tables. Avec des manches durables et résistants à l'eau, il assure une prise en main confortable.

Varietà per ogni occasione, grazie a design che si adattano a qualsiasi preferenza, ideali per diversi stili di tavola. Manici durevoli e resistenti all'acqua, che garantiscono una presa comoda.

Variedade para todas as ocasiões com designs que se adaptam a todas as preferências, ideais para diferentes estilos de mesa. Com cabos duráveis e resistentes à água, garante uma pega confortável.

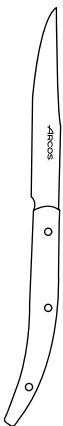

Acero Inoxidable

Stainless Steel · Acier Inoxydable · Acciaio Inossidabile · Aço Inoxidável.

Materiales Resistentes

Resistant Materials · Matériaux résistants · Materiali Resistenti · Materiais Resistentes.

Agarre Cómodo

Comfortable Grip · Prise Confortable · Impugnatura Comoda Pegada Confortável.

Resistente a la Corrosión

Corrosion Resistant · Résistants à la Corrosion · Resistenti alla Corrosione · Resistentes à Corrosão.

10 Años de Garantía

10-Year Warranty · Garantie 10 Ans · Garanzia 10 Anni
Garantia de 10 Anos.

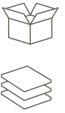
	Caja	Box	Boîte	Scatola	Caixa
	Acero Inoxidable NITRUM® Poliamidas	NITRUM® Stainless Steel Polyamides	Acier Inoxydable NITRUM® Polyamides	Acciaio Inossidabile NITRUM® Poliammidi	Aço Inoxidável NITRUM® Poliamidas



372400

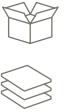

Chuletero (Perlado) // Steak Knife (Serrated) // C. Steak (Cranté) Coltello Bistecca (Seghettato) Faca de Churrasco (Perolado)

	Caja	Box	Boîte	Scatola	Caixa
	Acero Inoxidable Nitrum® Polipropileno	NITRUM® Stainless Steel Polypropylene	Acier Inoxydable NITRUM® Polypropylène	Acciaio Inossidabile NITRUM® Polipropilene	Aço Inoxidável NITRUM® Polipropileno



373300



Chuletero (Perlado) // Steak Knife (Serrated) // C. Steak (Cranté) Coltello Bistecca (Seghettato) Faca de churrasco (Perolado)



372900

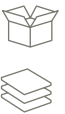

Chuletero (Filo) // Steak Knife (Cutting edge) // C. Steak (Lisse) Coltello Bistecca (Filo) // Faca de churrasco (Fio)

	Caja	Box	Boîte	Scatola	Caixa
	Acero Inoxidable Nitrum® Polioximetileno (POM)	NITRUM® Stainless Steel Polyoxymethylene (POM)	Acier Inoxydable NITRUM® Polyoxyméthylène (POM)	Acciaio Inossidabile NITRUM® Polioximetilene (POM)	Aço Inoxidável NITRUM® Polioximetileno (POM)



375200

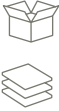

Chuletero (Filo) // Steak Knife (Cutting edge) // C. Steak (Lisse) Coltello Bistecca (Filo) // Faca de churrasco (Fio)

	Caja	Box	Boîte	Scatola	Caixa
	Acero Inoxidable Nitrum® Polioximetileno (POM)	NITRUM® Stainless Steel Polyoxymethylene (POM)	Acier Inoxydable NITRUM® Polyoxyméthylène (POM)	Acciaio Inossidabile NITRUM® Polioximetilene (POM)	Aço Inoxidável NITRUM® Polioximetileno (POM)



374800

115mm/4,5"
220mm/8,6"

Chuletero (Perlado) // Steak Knife (Serrated) // C. Steak (Cranté) Coltello Bistecca (Seghettato) Faca de Churrasco (Perlado)



374822

115mm/4,5"
220mm/8,6"

Chuletero (Perlado) // Steak Knife (Serrated) // C. Steak (Cranté) Coltello Bistecca (Seghettato) Faca de Churrasco (Perlado)



374824

115mm/4,5"
220mm/8,6"

Chuletero (Perlado) // Steak Knife (Serrated) // C. Steak (Cranté) Coltello Bistecca (Seghettato) Faca de Churrasco (Perlado)

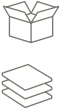
	Caja	Box	Boîte	Scatola	Caixa
	Acero Inoxidable 18/10 Polioximetileno (POM)	Stainless Steel 18/10 Polyoxymethylene (POM)	Acier Inoxydable 18/10 Polyoxyméthylène (POM)	Acciaio Inossidabile 18/10 Polioximetilene (POM)	Aço Inoxidável 18/10 Polioximetileno (POM)



374700

90mm/3,5"
195mm/7,6"

Tenedor // Steak Fork // Fourchette Table // Forchetta Bistecca Garfo



374722

90mm/3,5"
195mm/7,6"

Tenedor // Steak Fork // Fourchette Table // Forchetta Bistecca Garfo



374724

90mm/3,5"
195mm/7,6"

Tenedor // Steak Fork // Fourchette Table // Forchetta Bistecca Garfo

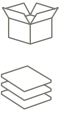
	Caja	Box	Boîte	Scatola	Caixa
	Acero Inoxidable NITRUM® Polioximetileno (POM) + Latón	NITRUM® Stainless Steel Polyoxymethylene (POM) + Brass	Acier Inoxydable NITRUM® Polyoxyméthylène (POM) + Laiton	Acciaio Inossidabile NITRUM® Polioximetilene (POM) + Ottone	Aço Inoxidável NITRUM® Polioximetileno (POM) + Latão



375000

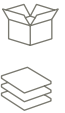

Chuletero (Perlado) // Steak Knife (Serrated) // C. Steak (Cranté) Coltello Bistecca (Seghettato) Faca de Churrasco (Perlado)

	Caja	Box	Boîte	Scatola	Caixa
	Acero Inoxidable 18/10 Polioximetileno (POM) + Latón	Stainless Steel 18/10 Polyoxymethylene (POM) + Brass	Acier Inoxydable 18/10 Polyoxyméthylène (POM) + Laiton	Acciaio Inossidabile 18/10 Polioximetilene e (POM) + Ottone	Aço Inoxidável 18/10 Polioximetileno (POM) + Latão



375100

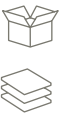

Tenedor // Steak Fork // Fourchette Table // Forchetta Bistecca Garfo Mesa

	Caja	Box	Boîte	Scatola	Caixa
	Acero Inoxidable NITRUM® Polipropileno	NITRUM® Stainless Steel Polypropylene	Acier Inoxydable NITRUM® Polypropylène	Acciaio Inossidabile NITRUM® Polipropilene	Aço Inoxidável NITRUM® Polipropileno



803000





Chuletero (Perlado) // Steak Knife (Serrated) // C. Steak (Cranté) Coltello Bistecca (Seghettato) Faca de Churrasco (Perlado)



740009



Chuletero (Perlado) // Steak Knife (Serrated) // C. Steak (Cranté) Coltello Bistecca (Seghettato) Faca de Churrasco (Perlado)

	Caja	Box	Boîte	Scatola	Caixa
	Acero Inoxidable NITRUM® Polipropileno	NITRUM® Stainless Steel Polypropylene	Acier Inoxydable NITRUM® Polypropylène	Acciaio Inossidabile NITRUM® Polipropilene	Aço Inoxidável NITRUM® Polipropileno



805109



Chuletero (Perlado) // Steak Knife (Serrated) // C. Steak (Cranté) Coltello Bistecca (Seghettato) Faca de Churrasco (Perolado)

	Caja	Box	Boîte	Scatola	Caixa
	Acero Inoxidable NITRUM® Poliamidas	NITRUM® Stainless Steel Polyamides	Acier Inoxydable NITRUM® Polyamides	Acciaio Inossidabile NITRUM® Poliammidi	Aço Inoxidável NITRUM® Poliamidas



804000



Chuletero (Perlado) // Steak Knife (Serrated) // C. Steak (Cranté) Coltello Bistecca (Seghettato) Faca de Churrasco (Perolado)

	Caja	Box	Boîte	Scatola	Caixa
	Acero Inoxidable 18/10 Poliamidas	Stainless Steel 18/10 Polyamides	Acier Inoxydable 18/10 Polyamides	Acciaio Inossidabile 18/10 Poliammidi	Aço Inoxidável 18/10 Poliamidas



804100

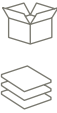

Tenedor // Steak Fork // Fourchette Table // Forchetta Bistecca Garfo

	<p>Caja</p> <p>Acero Inoxidable NITRUM® Polipropileno</p>	<p>Box</p> <p>NITRUM® Stainless Steel Polypropylene</p>	<p>Boîte</p> <p>Acier Inoxydable NITRUM® Polypropylène</p>	<p>Scatola</p> <p>Acciaio Inossidabile NITRUM® Polipropilene</p>	<p>Caixa</p> <p>Aço Inoxidável NITRUM® Polipropileno</p>
---	---	---	--	--	--



6 X 373300



377200

Juego Chuleteros (Filo) 4 piezas // Set
4 Pc. // C. Steak (Lisse) // Set 4 Steak
(Lisse) Set Steak 4 Pezzi // Conjunto 4
Peças (Fio)



6 X 373371



830600

Juego Chuleteros (Filo) 4 piezas // Set
4 Pc. // C. Steak (Lisse) // Set 4 Steak
(Lisse) Set Steak 4 Pezzi // Conjunto 4
Peças (Fio)

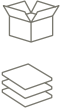
	<p>Caja Acero Inoxidable NITRUM® Polipropileno</p>	<p>Box NITRUM® Stainless Steel Polypropylene</p>	<p>Boîte Acier Inoxydable NITRUM® Polypropylène</p>	<p>Scatola Acciaio Inossidabile NITRUM® Polipropilene</p>	<p>Caixa Aço Inoxidável NITRUM® Polipropileno</p>
---	--	--	---	---	---



6 X 373372



830700

Juego Chuleteros (Filo) 4 piezas // Set
4 pc. // C. Steak (Lisse) // Set 4 Steak
(Lisse) Set Steak 4 Pezzi // Conjunto 4
Peças (Fio)



6 X 373373



830800

Juego Chuleteros (Filo) 4 piezas // Set
4 pc. // C. Steak (Lisse) // Set 4 Steak
(Lisse) Set Steak 4 Pezzi // Conjunto 4
Peças (Fio)



ARCOS
ALBACETE-SPAIN

TABLE KNIVES
COUTEAUX DE TABLE
COLTELLI DA TABOLA
FACAS DE MESA

CUCHILLOS
MESA



FLYSCH
PÁG 178-179



STEEL-TABLE
PÁG 180-181



TABLE BASIC
PÁG 182-183



PIANO CLASSIC
PÁG 184-185





SERIE FLYSCH

Un cuchillo distintivo con mango que captura la esencia de las formaciones geológicas atlánticas, ideal para mesas que valoran la precisión y la estética natural.

A distinctive knife with a handle that captures the essence of the Atlantic geological formations, ideal for tables that value precision and natural aesthetics.

Un couteau distinctif avec un manche qui capture l'essence des formations géologiques de l'Atlantique, idéal pour les tables qui apprécient la précision et l'esthétique naturelle.

Un coltello caratteristico, con un manico che cattura l'essenza delle formazioni geologiche atlantiche, ideale per tavole che apprezzano la precisione e l'estetica naturale.

Uma faca distintiva com um cabo que capta a essência das formações geológicas atlânticas, ideal para mesas que valorizam a precisão e a estética natural.



Acero Inoxidable NITRUM®

NITRUM® Stainless Steel · Acier Inoxydable NITRUM® · Acciaio Inossidabile NITRUM® · Aço Inoxidável NITRUM®.



Microdentado

Micro-serrated · Microdenté · Microdentato · Micro-perlage Microdentado.

Brillo Espejo

Mirror Finish · Polissage Miroir · Lucentezza Specchio · Brilho Espelho.

Gran Poder de Corte

Great Cutting power · Grand Pouvoir de Coupe · Grande Potere di Taglio · Grande Poder de Corte.



Remaches de Latón

Brass Rivets · Rivets en Laiton · Rivetti in Ottone · Rebites de Latão.

10 Años de Garantía

10-Year Warranty · Garantie 10 Ans · Garanzia 10 Anni · Garantia de 10 Anos.

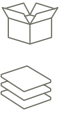
	Caja	Box	Boîte	Scatola	Estojo
	Acero Inoxidable NITRUM® Polimetil Metacrilato (PMMA)	NITRUM® Stainless Steel Polymethyl Methacrylate (PMMA)	Acier Inoxydable NITRUM® Polyméthacrylate de Méthyle	Acciaio Inossidabile NITRUM® Polimetil Metacrilato (PMMA)	Aço Inoxidável NITRUM® Polimetil Metacrilato (PMMA)



373800

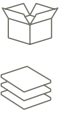

Cuchillo Mesa (Microdentado)
Table Knife (Micro-Serrated)
Couteau Table (Microdenté)
Coltello Tavola (Microdentato)
Faca Mesa (Micro-Perlage)

	Estuche	Case	Étui	Astuccio	Estojo
	Acero Inoxidable NITRUM® Polimetil Metacrilato (PMMA)	NITRUM® Stainless Steel Polymethyl Methacrylate (PMMA)	Acier Inoxydable NITRUM® Polyméthacrylate de Méthyle	Acciaio Inossidabile NITRUM® Polimetil Metacrilato (PMMA)	Aço Inoxidável NITRUM® Polimetil Metacrilato (PMMA)

374000

Juego 4 pzas. // 4 pc. Steak Set // Set 4
Steak // Set 4 Pezzi // Conjunto 4 Peças



4 X 373800





STEEL-TABLE

Variación para cada ocasión con diseños que se adaptan a cualquier preferencia, ideales para diferentes estilos de mesa. Con mangos duraderos y resistentes al agua, garantiza un agarre cómodo.

Variety for each occasion with designs that adapt to any preference, ideal for different table styles. With durable and water-resistant handles that guarantee a comfortable grip.

De la variété pour toutes les occasions avec des designs adaptés à toutes les préférences, parfait pour différents styles de tables. Avec des manches durables et résistants à l'eau, il assure une prise en main confortable.

Varietà per ogni occasione, grazie a design che si adattano a qualsiasi preferenza, ideali per diversi stili di tavola.

Manici durevoli e resistenti all'acqua, che garantiscono una presa comoda. Variedade para todas as ocasiões com designs que se adaptam a todas as preferências, ideais para diferentes estilos de mesa. Com cabos duráveis e resistentes à água, garante uma pega confortável.



Acero Inoxidable

Stainless Steel · Acier Inoxydable · Acciaio Inossidabile Aço Inoxidável.

Fabricados de una Sola Pieza

Made in One Piece · Fabriqué en une Seule Pièce
Fabbricati in un Unico Pezzo · Fabricados em uma Única Peça.

No Necesita Afilado

No Need for Sharpening · Ne nécessite pas D'Affûtage · Non Necessita di affilatura · Não Precisa de Afição.

Diseño Clásico

Classic design · Design Classique · Design classico · Design Clássico.

10 Años de Garantía

10-Year Warranty · Garantie 10 Ans · Garanzia 10 Anni
Garantia de 10 Anos.

	Caja	Box	Boîte	Scatola	Caixa
	Acero Inoxidable	Stainless Steel	Acier Inoxydable	Acciaio Inossidabile	Aço Inoxidável



460100



Cuchillo Postre (Perlado)
Dessert Knife (Serrated)
C. Dessert (Cranté) // Coltello
Frutta (Seghettato) // Faca
Sobremesa (Perolado)



460400



Cuchillo Mesa (Perlado) // Table
Knife (Serrated) // Couteau
Table (Cranté) // Coltello Tavola
(Seghettato) // Faca Mesa
(Perolado)



SERIE TABLE BASIC

La unión perfecta de ligereza y durabilidad, esenciales de uso diario que aportan tradición artesanal y practicidad a tu cubertería.

The perfect blend of lightness and durability, essential for daily use that provides your cutlery with artisan tradition and practicality.

La combinaison parfaite de légèreté et de durabilité, essentielles dans une utilisation quotidienne, apportant de la tradition artisanale et du pratique à vos couverts.

La perfetta unione di leggerezza e durevolezza, imprescindibili di uso quotidiano che apportano tradizione artigianale e praticità alla vostra posateria.

A união perfeita entre leveza e durabilidade, essenciais para o quotidiano, que trazem o artesanato tradicional e a praticidade à sua cutelaria.



Acero Inoxidable NITRUM®

NITRUM® Stainless Steel · Acier Inoxydable NITRUM® · Acciaio Inossidabile NITRUM® · Aço Inoxidável NITRUM®.

Materiales Resistentes

Resistant Materials · Matériaux Résistants · Materiali Resistenti · Materiais Resistentes.

Agarre Cómodo

Comfortable Grip · Prise Confortable · Impugnatura Comoda Pegada Confortável.



Plásticos Técnicos (PP)



Technical Plastics (Polipropileno) · Plastiques Techniques (Polypropylene) · Plastiche Tecniche (Polypropylène) · Plásticos Técnicos (Polipropilene)

10 Años de Garantía

10-Year Warranty · Garantie 10 Ans · Garanzia 10 Anni
Garantia de 10 Anos.

Diseño Ligero

Light Weight Design · Conception Légère · Design Leggero
Design Leve.

	Caja	Box	Boîte	Scatola	Caixa
	Acero Inoxidable NITRUM® Polipropileno (PP)	NITRUM® Stainless Steel Polypropylene (PP)	Acier Inoxydable NITRUM® Polypropylène (PP)	Acciaio Inossidabile NITRUM® Polipropilene (PP)	Aço Inoxidável NITRUM® Polipropileno (PP)



370100



Cuchillo Postre (Perlado)
Dessert Knife (Serrated)
C. Dessert (Cranté) // Coltello
Frutta (Seghettato) // Faca
Sobremesa (Perolado)



370200



**Cuchillo Mesa (Perlado) // Table
Knife (Serrated) // Couteau
Table (Cranté) // Coltello Tavola
(Seghettato) // Faca Mesa
(Perolado)**



802900



**Cuchillo Mesa (Perlado) // Table
Knife (Serrated) // Couteau
Table (Cranté) // Coltello Tavola
(Seghettato) // Faca Mesa
(Perolado)**



802910



**Cuchillo Mesa (Perlado) // Table
Knife (Serrated) // Couteau
Table (Cranté) // Coltello Tavola
(Seghettato) // Faca Mesa
(Perolado)**



SERIE PIANO CLASSIC

Funcionalidad cotidiana: resistente, con un diseño de vanguardia. Sus cuchillos no requieren afilado frecuente, asegurando un corte perfecto con cada uso gracias a su duradero filo perlado.

Everyday practicality: strong, with a state-of-the-art design. Frequent sharpening is not required for these knives, a perfect cut is guaranteed whenever they are used thanks to the long-lasting pearled edge of the blade.

Fonctionnalité au quotidien : robuste, avec un design avant-gardiste. Ses couteaux ne nécessitent pas d'affûtage fréquent, assurant une découpe parfaite à chaque utilisation grâce à leur tranchant cranté durable.

Funcionalità quotidiana: resistente e dal design d'avanguardia. Questi coltelli non richiedono affilature frequenti e garantiscono un taglio perfetto ad ogni utilizzo, grazie al loro durevole filo perlato.

Funcionalidade quotidiana: resistente, com um design de vanguarda. As suas facas não necessitam de ser afiadas com frequência, garantindo um corte perfeito em cada utilização graças ao seu fio perolado de longa duração.



Acero Inoxidable

Stainless Steel · Acier Inoxydable · Acciaio Inossidabile · Aço Inoxidável.

Diseño Clásico

Classic Design · Design Classique · Design Classico · Design Clássico.

Materiales Resistentes

Resistant Materials · Matériaux Résistants · Materiali Resistenti · Materiais Resistentes.

No Necesita Afilado

No Need for Sharpening · Ne nécessite Pas D'Affûtage · Non Necessita di Affilatura · Não Precisa de Afição.

Remaches de Acero Inox

Stainless Steel Rivets · Rivets en Acier Inoxydable · Rivetti in Acciaio Inossidabile · Rebites de Aço Inoxidável.

10 Años de Garantía

10-Year Warranty · Garantie 10 Ans · Garanzia 10 Anni · Garantia de 10 Anos.

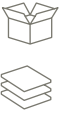
	Caja	Box	Boîte	Scatola	Caixa
	Acero Inoxidable NITRUM® Poliamidas	NITRUM® Stainless Steel Polyamides	Acier Inoxydable NITRUM® Polyamides	Acciaio Inossidabile NITRUM® Poliammidi	Aço Inoxidável NITRUM® Poliamidas



370600

110mm/4,3"
195mm/7,6"

Cuchillo Postre (Perlado)
Dessert Knife (Serrated)
C. Dessert (Cranté) // Coltello
Frutta (Seghettato) // Faca
Sobremesa (Perolado)



370000

115mm/4,5"
216mm/8,5"

**Cuchillo Mesa (Perlado) // Table
Knife (Serrated) // Couteau
Table (Cranté) // Coltello
Tavola (Seghettato) // Faca
Mesa (Perolado)**



370625

110mm/4,3"
195mm/7,6"

Cuchillo Postre (Perlado)
Dessert Knife (Serrated)
C. Dessert (Cranté) // Coltello
Frutta (Seghettato) // Faca
Sobremesa (Perolado)



370025

115mm/4,5"
216mm/8,5"

**Cuchillo Mesa (Perlado) // Table
Knife (Serrated) // Couteau
Table (Cranté) // Coltello
Tavola (Seghettato) // Faca
Mesa (Perolado)**

	Caja	Box	Boîte	Scatola	Caixa
	Acero Inoxidable 18/10 Poliamidas	Stainless Steel 18/10 Polyamides	Acier Inoxydable 18/10 Polyamides	Acciaio Inossidabile 18/10 Poliammidi	Aço Inoxidável 18/10 Poliamidas



370500

100mm/3,9"
195mm/7,6"

**Tenedor // Steak Fork // Fourchette
Table // Forchetta Bistecca
Garfo Mesa**



370525

100mm/3,9"
195mm/7,6"

**Tenedor // Steak Fork // Fourchette
Table // Forchetta Bistecca
Garfo Mesa**

FLATWARE
LES COUVERTS
POSATERIA
TALHERES



CUBERTERÍAS



MANCHEGA
PÁG 188-190



CAPRI
PÁG 200-205



MILANO
PÁG 191-193



BERLIN
PÁG 206-211



LISBOA
PÁG 194-199



TOSCANA
PÁG 212-217



SERIE MANCHEGA



Cautive en cada bocado con la cubertería Manchega. Un tributo a la mesa moderna con mangos que evocan herencia, diseño que perdura y una calidad que realza su cocina diaria.

Captivate with every bite with the Manchega cutlery. A tribute to the modern table with handles that evoke heritage, a design that endures, and a quality that enhances your everyday cooking.

Régalez-vous à chaque bouchée avec les couverts Manchega. Des manches qui rendent hommage à nos traditions, un design qui dure et une qualité qui réhausse votre cuisine de tous les jours.

Cattura ad ogni morso con la posateria Manchega. Un tributo alla tavola moderna con manici che evocano l'eredità, un design che persiste e una qualità che esalta la tua cucina quotidiana.

Cativa a cada garfada com a talheres Manchega. Uma homenagem à mesa moderna com cabos que evocam herança, design que perdura e uma qualidade que realça a sua cozinha diária.

	Caja	Box	Boîte	Scatola	Caixa
	Acero Inoxidable NITRUM® Madera Comprimida	NITRUM® Stainless Steel Pack-Wood	Acier Inoxydable NITRUM® Bois Compressé	Acciaio Inossidabile NITRUM® Legno Compresso	Aço Inoxidável NITRUM® Madeira Comprimida



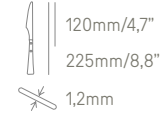

NEW

479400



Cuchillo Mesa (Perlado) // Table Knife (Serrated) // Couteau Table (Cranté) // Coltello Tavola (Seghettato) // Faca Mesa (Perolado)

	Caja	Box	Boîte	Scatola	Caixa
	Acero Inoxidable 18/10 Madera Comprimida	Stainless Steel 18/10 Pack-Wood	Acier Inoxydable 18/10 Bois Compressé	Acciaio Inossidabile 18/10 Legno Compresso	Aço Inoxidável 18/10 Madeira Comprimida



NEW

479200



Cuchara Postre // Dessert Spoon
Cuillère Dessert // Cucchiario Frutta // Colher Sobremesa



NEW

479500



Cuchara Mesa // Table Spoon
Cuillère Table // Cucchiario Tavola
Colher Mesa





NEW

479600



Tenedor Mesa // Table Fork
Fourchette Table // Forchetta Tavola // Garfo Mesa

 	Estuche 479400. Acero Inoxidable NITRUM® 479200, 479500, 479600 Acero Inoxidable 18/10 Madera Comprimida	Gift Case 479400. NITRUM® Stainless Steel 479200, 479500, 479600 Stainless Steel 18/10 Pack-Wood	Ménagère 479400. Acier Inoxydable NITRUM® 479200, 479500, 479600. Acier Inoxydable 18/10 Bois Compressé	Confezione Regalo 479400. Acciaio Inossidabile NITRUM® 479200, 479500, 479600 Acciaio Inossidabile 18/10 Legno Compresso	Caixa de Presente 479400. Acero Inoxidable NITRUM® 479200, 479500, 479600 Aço Inoxidável 18/10 Madeira comprimida
--	--	--	---	--	---



NEW

480100

Estuche 16 Piezas // 16 Pc. Set
 Ménagère 16 Pièces // Confezione 16 Pezzi
 Conjunto 16 Peças



4 X 479400



4 X 479500



4 X 479600



4 X 479200

16



SERIE MILANO

Con líneas minimalistas y elegantes, ofrece cubiertos sencillos fabricados en una sola pieza de acero inoxidable, perfectos para una estética moderna y sofisticada.

With minimalistic and elegant lines, simple cutlery made in one single piece of stainless steel, perfect to create a sophisticated and modern look.

Avec des lignes minimalistes et élégantes, cette série intègre des couverts simples faits d'une seule pièce d'acier inoxydable, parfaits pour une esthétique moderne et sophistiquée.

Linee minimaliste ed eleganti che si concretizzano in posate semplici, fabbricate in un unico pezzo di acciaio inossidabile, perfette per un'estetica moderna e sofisticata.

Com linhas minimalistas e elegantes, oferece talheres simples feitos numa única peça de aço inoxidável, perfeitos para uma estética moderna e sofisticada.

	Caja	Box	Boîte	Scatola	Caixa
	Acero Inoxidable	Stainless Steel	Acier Inoxydable	Acciaio Inossidabile	Aço Inoxidável



541500



Cuchillo Mesa (Perlado) // Table Knife (Serrated) // Couteau Table (Cranté) // Coltello Tavola (Seghettato) // Faca Mesa (Perolado)

	Caja	Box	Boîte	Scatola	Caixa
	Acero Inoxidable 18/10	Stainless Steel 18/10	Acier Inoxydable 18/10	Acciaio Inossidabile 18/10	Aço Inoxidável 18/10



541300



**Cuchara Café // Coffee Spoon
Cuillère Café // Cucchiaino Caffè
Colher Café**



541600

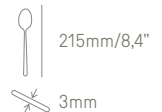

**Cuchara Mesa // Table Spoon
Cuillère Table // Cucchiaino Tavola
Colher mesa**



541700

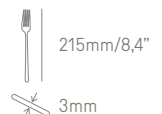





**Tenedor Mesa // Table Fork
Fourchette Table // Forchetta
Tavola // Garfo Mesa**

	Estuche	Gift Case	Ménagère	Confezione Regalo	Caixa de Presente
	5415. Acero Inoxidable 5416, 5417, 5413. Acero Inoxidable 18/10	5415. Stainless Steel 5416, 5417, 5413. Stainless Steel 18/10T	5415. Acier Inoxydable 5416, 5417, 5413. Acier Inoxydable 18/10	5415. Acciaio Inossidabile 5416, 5417, 5413. Acciaio Inossidabile 18/10	5415. Acero Inoxidable 5416, 5417, 5413. Aço Inoxidável 18/10

542000

Estuche 24 Piezas // 24 Pc. Set
Ménagère 24 Pièces // Confezione 24 Pezzi
Conjunto 24 Peças

-  6 X 5415
-  6 X 5416
-  6 X 5417
-  6 X 5413

24





SERIE LISBOA



Cuartería Lisboa, con su encanto clásico y tradicional, realza cualquier ocasión, ofreciendo un toque de elegancia a la mesa con su diseño atemporal.

Lisboa cutlery, with its classic and traditional charm, enhances any occasion, by providing a touch of elegance to the table with its timeless design.

Les couverts Lisboa, avec leur charme classique et traditionnel, rehaussent toutes les occasions, offrant une touche d'élégance à la table avec leur design intemporel.

La posateria Lisboa, grazie al suo fascino classico e tradizionale, valorizza qualsiasi occasione, giacché il suo design atemporale dona un tocco di eleganza alla tavola.

A cutelaria Lisboa, com o seu charme clássico e tradicional, realça qualquer ocasião, oferecendo um toque de elegância à mesa com o seu design intemporal.

	Caja	Box	Boîte	Scatola	Caixa
	Acero Inoxidable	Stainless Steel	Acier Inoxydable	Acciaio Inossidabile	Aço Inoxidável



595200

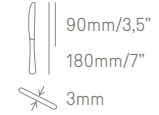

Cuchillo Lunch (Perlado) // Cake Knife (Serrated) // Couteau Lunch (Cranté) // Coltello Frutta (Seghettato) // Faca Lunch (Perolado)



597600

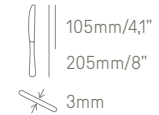

Cuchillo Postre (Perlado) // Dessert Knife (Serrated) // Couteau Dessert (Cranté) // Coltello Frutta (Seghettato) // Faca Sobremesa (Perolado)



596200



Cuchillo Pescado // Fish Knife // Couteau Poisson // Coltello Pesce // Faca Peixe



595600



Chuletero (Perlado) // Steak Knife (Serrated) // Couteau Steak (Cranté) // Coltello Bistecca (Seghettato) // Faca Churrasco (Perolado)



595900



Cuchillo Mesa (Perlado) // Table Knife (Serrated) // Couteau Table (Cranté) // Coltello Tavola (Seghettato) // Faca Mesa (Perolado)

	Caja	Box	Boîte	Scatola	Caixa
	Acero Inoxidable 18/10	Stainless Steel 18/10	Acier Inoxydable 18/10	Acciaio Inossidabile 18/10	Aço Inoxidável 18/10



595000

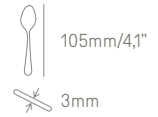

Cuchara Moka // Mokka Spoon
Cuillère Moka // Cucchiaino Moka
Colher Moka



595100



Cuchara Café // Coffee Spoon
Cuillère Café // Cucchiaino Caffè
Colher Café



595500



Cuchara Helado // Ice Cream Spoon
Spoon // Cuillère Glace // Paletta
Gelato // Colher Gelado



595300



Cuchara Lunch // Cake Spoon
Cuillère Lunch // Cucchiaino Frutta
Colher Lunch



595700

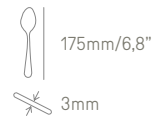

Cuchara Postre // Dessert Spoon
Cuillère Dessert // Cucchiaino
Frutta // Colher Sobremesa



596000

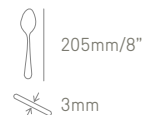

Cuchara Mesa // Table Spoon
Cuillère Table // Cucchiaino Tavola
Colher mesa

	Caja	Box	Boîte	Scatola	Caixa
	Acero Inoxidable 18/10	Stainless Steel 18/10	Acier Inoxydable 18/10	Acciaio Inossidabile 18/10	Aço Inoxidável 18/10



597100

 200mm/7,8"

 3mm

Cuchara Refresco // Ice Tea Spoon
Cuillère à Glace // Cucchiaino Tè
Colher Refresco



597200

 240mm/9,4"

 3mm

Cuchara Ensalada // Salad Spoon
Cuillère Salade // Cucchiaine
Insalata // Colher Ensalada



596800

 260mm/10,2"

 3mm

Cuchara Servir // Serving Spoon
Cuillère Service // Cucchiaine
Servire // Colher Servir



596600

 175mm/6,8"

 3mm

Cacillo Salsa // Gravy Ladle
Louche à Crème // Mestolo Salsa
Concha Molho



597000

 280mm/11"

 3mm

Cazo Sopa // Soup Ladle
Louche // Mestolo // Concha Sopa



596900

 250mm/9,8"

 3mm

Pala Pastel // Cake Server
Pelle à Tarte // Pala Torta
Pá Torta

	Caja	Box	Boîte	Scatola	Caixa
	Acero Inoxidable 18/10	Stainless Steel 18/10	Acier Inoxydable 18/10	Acciaio Inossidabile 18/10	Aço Inoxidável 18/10



595400



Tenedor Lunch // Cake Fork
Fourchette Lunch // Forchetta
Frutta // Garfo Lunch



595800

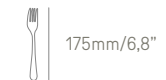

Tenedor Postre // Dessert Fork
Fourchette Dessert // Forchettina
Dolce // Garfo Sobremesa



596300

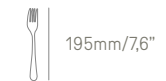

Tenedor Pescado // Fish Fork
Fourchette Poisson // Forchettina
Pesce // Garfo Peixe



596100



Tenedor Mesa // Table Fork
Fourchette Table // Forchetta
Tavola // Garfo Mesa



597300

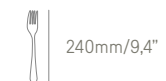

Tenedor Ensalada // Salad Fork
Fourchette Salade // Forchettone
Insalata // Garfo Ensalada



596700

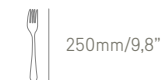

Tenedor Servir // Serving Fork
Fourchette Service // Forchettone
Servire // Garfo Servir

	Estuche 5956. Acero Inoxidable 5951, 5960, 5961. Acero Inoxidable 18/10	Gift Case 5956. Stainless Steel 5951, 5960, 5961. Stainless Steel 18/10	Ménagère 5956. Acier Inoxydable 5951, 5960, 5961. Acier Inoxydable 18/10	Confezione Regalo 5956. Acciaio Inossidabile 5951, 5960, 5961. Acciaio Inossidabile 18/10	Caixa de Presente 5956. Aço Inoxidável 5951, 5960, 5961. Aço Inoxidável 18/10
--	---	---	--	---	---

- 6 X 5956
- 6 X 5960
- 6 X 5961
- 6 X 5951

24



597400

Estuche 24 Piezas // 24 Pc. Set
Ménagère 24 Pièces // Confezione 24 Pezzi
Conjunto 24 Peças

	Maletín 5956, 5952, 5962. Acero Inoxidable NITRUM® 5960, 5961, 5951, 5954, 5950, 5963, 5970, 5968, 5973, 5972, 5962. Acero Inoxidable 18/10	Gift Case 5956, 5952, 5962. NITRUM® Stainless Steel 5960, 5961, 5951, 5954, 5950, 5963, 5970, 5968, 5973, 5972, 5962 Stainless Steel 18/10	Ménagère 5956, 5952, 5962. Acier Inoxydable NITRUM® 5960, 5961, 5951, 5954, 5950, 5963, 5970, 5968, 5973, 5972, 5962. Acier Inoxydable 18/10	Astuccio 5956, 5952, 5962. Acciaio Inossidabile NITRUM® 5960, 5961, 5951, 5954, 5950, 5963, 5970, 5968, 5973, 5972, 5962. Acciaio Inossidabile 18/10	Maleta 5956, 5952, 5962. Aço Inoxidável NITRUM® 5960, 5961, 5951, 5954, 5950, 5963, 5970, 5968, 5973, 5972, 5962. Aço Inoxidável 18/10
--	---	--	--	--	--

- 12 X 5956
- 12 X 5960
- 12 X 5961
- 12 X 5952
- 12 X 5951
- 12 X 5954
- 12 X 5950
- 12 X 5962
- 12 X 5963
- 1 X 5970
- 1 X 5968
- 1 X 5973
- 1 X 5972
- 1 X 5969

113



597500

Maletín 113 Piezas // 113 pc. Gift Case
Ménagère 113 pièces // Astuccio 113 Pezzi
Conjunto 113 Peças



SERIE CAPRI



La serie Capri aporta un diseño innovador a su mesa, combinando modernidad y elegancia, una elección perfecta para espacios que buscan un ambiente contemporáneo.

The Capri series adds an innovative design to your table, by combining modernity and elegance, a perfect choice for places where a contemporary atmosphere is required.

La série Capri apporte un design innovant à votre table, alliant modernité et élégance, un choix parfait pour les espaces à la recherche d'une atmosphère contemporaine.

La serie Capri apporta un design innovatore alla vostra tavola, giacché unisce modernità ed eleganza, una scelta perfetta per spazi che aspirano a creare un ambiente contemporaneo.

A série Capri traz um design inovador para a sua mesa, combinando modernidade e elegância, uma escolha perfeita para espaços que procuram um ambiente contemporâneo.

	Caja	Box	Boîte	Scatola	Caixa
	Acero Inoxidable	Stainless Steel	Acier Inoxydable	Acciaio Inossidabile	Aço Inoxidável



585200

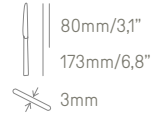

Cuchillo Lunch (Perlado) // Cake Knife (Serrated) // Couteau Lunch (Cranté) // Coltello Frutta (Seghettato) // Faca Lunch (Perlado)



585600



Cuchillo Postre (Perlado)
Dessert Knife (Serrated)
Couteau Dessert (Cranté)
Coltello Frutta (Seghettato)
Faca Sobremesa (Perlado)



586400



Chuletero (Perlado) // Steak Knife (Serrated) // C. Steak (Cranté)
Coltello Bistecca (Seghettato)
Faca de churrasco (Perlado)



585900



Cuchillo Mesa (Perlado) // Table Knife (Serrated) // Couteau Table (Cranté) // Coltello Tavola (Seghettato) //Faca Mesa (Perlado)



586200



Cuchillo Pescado // Fish Knife
Couteau Poisson // Coltello Pesce
Faca Peixe

	Caja	Box	Boîte	Scatola	Caixa
	Acero Inoxidable 18/10	Stainless Steel 18/10	Acier Inoxydable 18/10	Acciaio Inossidabile 18/10	Aço Inoxidável 18/10



585000



Cuchara Moka // Mocca Spoon
Cuillère Moka //Cucchiaino Moka
Colher Moka



585100

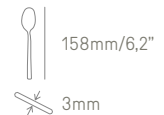

Cuchara Café-Lunch // Coffee-Cake Spoon // Cuillère Café-Lunch
Cucchiaino Caffè-Frutta // Colher Café-lunch



585700

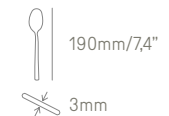

Cuchara Postre // Dessert Spoon
Cuillère Dessert // Cucchiaio Frutta // Colher Sobremesa



586800



Cuchara Ensalada // Salad Spoon
Cuillère Salade //Cucchiaione Insalata // Colher Ensalada



586000

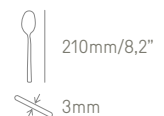

Cuchara Mesa // Table Spoon
Cuillère Table // Cucchiaio Tavola
Colher mesa



586600

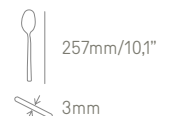

Cuchara Servir // Serving Spoon
Cuillère Service //Cucchiaione Servire // Colher Servir

	Caja	Box	Boîte	Scatola	Caixa
	Acero Inoxidable 18/10	Stainless Steel 18/10	Acier Inoxydable 18/10	Acciaio Inossidabile 18/10	Aço Inoxidável 18/10



585400

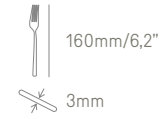

Tenedor Lunch // Cake Fork
Fourchette Lunch // Forchetta
Frutta // Garfo Lunch



585800

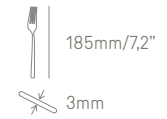

Tenedor Postre // Dessert Fork
Fourchette Dessert // Forchettina
Dolce // Garfo Sobremesa



586100

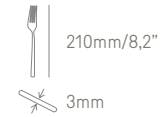

Tenedor Mesa // Table Fork
Fourchette Table // Forchetta
Tavola // Garfo Mesa



586300



Tenedor Pescado // Fish Fork
Fourchette Poisson // Forchettina
Pesce // Garfo Peixe



586700

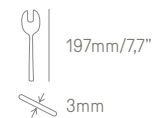

Tenedor Ensalada // Salad Fork
Fourchette Salade // Forchettone
Insalata // Garfo Ensalada

	Caja	Box	Boîte	Scatola	Caixa
	Acero Inoxidable 18/10	Stainless Steel 18/10	Acier Inoxydable 18/10	Acciaio Inossidabile 18/10	Aço Inoxidável 18/10



587000

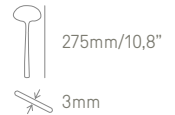

Cazo Sopa // Soup Ladle // Louche
Mestolo // Concha Sopa





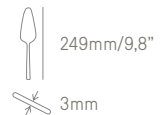

586900



Pala Pastel // Cake Server // Pelle
à Tarte // Pala Torta // Pá Torta

	Estuche	Gift Case	Ménagère	Confezione Regalo	Caixa de Presente
	5859 Acero Inoxidable 5860, 5861, 5851. Acero Inoxidable 18/10	5859 Stainless Steel 5860, 5861, 5851. Stainless Steel 18/10	5859 Acier Inoxydable 5860, 5861, 5851. Acier Inoxydable 18/10	5859 Acciaio Inossidabile 5860, 5861, 5851. Acciaio Inossidabile 18/10	5859 Aço Inoxidável 5860, 5861, 5851. Aço Inoxidável 18/10

-  6 X 5859
-  6 X 5860
-  6 X 5861
-  6 X 5851

24



587400

Estuche 24 Piezas // 24 Pc. Set
Ménagère 24 Pièces // Confezione 24 Pezzi
Conjunto 24 Peças

	Maletín	Gift Case	Ménagère	Confezione Regalo	Maleta
	5859, 5852, 5862 Acero Inoxidable	5859, 5852, 5862 Stainless Steel	5859, 5852, 5862 Acier Inoxydable	5859, 5852, 5862 Acciaio Inossidabile	5859, 5852, 5862 Aço Inoxidável
	5860, 5861, 5851, 5854, 5850 5863, 5870, 5866, 5867, 5868, 5869 Acero Inoxidable 18/10	5860, 5861, 5851, 5854, 5850 5863, 5870, 5866, 5867, 5868, 5869 Stainless Steel 18/10	5860, 5861, 5851, 5854, 5850 5863, 5870, 5866, 5867, 5868, 5869 Acier Inoxydable 18/10	5860, 5861, 5851, 5854, 5850 5863, 5870, 5866, 5867, 5868, 5869 Acciaio Inossidabile 18/10	5860, 5861, 5851, 5854, 5850 5863, 5870, 5866, 5867, 5868, 5869 Aço Inoxidável 18/10

587200

Maletín 113 Piezas // 113 pc. Gift Case
Ménagère 113 pièces // Confezione 113
Pezzi // Conjunto 113 Peças

-  12 X 5859
-  12 X 5860
-  12 X 5861
-  12 X 5852
-  12 X 5851
-  12 X 5854
-  12 X 5850
-  12 X 5862
-  12 X 5863
-  1 X 5870
-  1 X 5866
-  1 X 5867
-  1 X 5868
-  1 X 5869

113





La serie Berlín aporta durabilidad y estilo con sus formas ovaladas y diseño atemporal, ideal para realzar mesas que buscan sofisticación, calidad y un aire de tradición renovada.



The Berlín series stands for durability and style with its oval shapes and classic design, ideal to enhance tables where sophistication, quality and a touch of revamped tradition is required.

La série Berlin apporte durabilité et style avec ses formes ovales et son design intemporel, idéale pour mettre en valeur les tables à la recherche de sophistication, de qualité et d'un air de tradition renouvelée.

La serie Berlín aporta durevolezza e stile grazie alle sue forme ovali e al design atemporale, ideale per dare protagonismo alle tavole che ricercano sofisticazione, qualità e un'aria di tradizione rinnovata.

A série Berlin traz durabilidade e estilo com as suas formas ovais e design intemporal, ideal para valorizar mesas que procuram sofisticação, qualidade e um ar de tradição renovada.

SERIE BERLÍN

	Caja	Box	Boîte	Scatola	Caixa
	Acero Inoxidable	Stainless Steel	Acier Inoxydable	Acciaio Inossidabile	Aço Inoxidável



560200



Cuchillo Lunch (Perlado) // Cake Knife (Serrated) // Couteau Lunch (Cranté) // Coltello Frutta (Seghettato) // Faca Lunch (Perolado)



560600



Cuchillo Postre (Perlado)
Dessert Knife (Serrated)
Couteau Dessert (Cranté)
Coltello Frutta (Seghettato)
Faca Sobremesa (Perolado)



561200



Cuchillo Pescado // Fish Knife
Couteau Poisson // Coltello Pesce
Faca Peixe



560900



Cuchillo Mesa (Perlado) // Table Knife (Serrated) // Couteau Table (Cranté) // Coltello Tavola (Seghettato) // Faca Mesa (Perolado)



560902



Cuchillo Mesa (Micro-Perlado)
Table Knife (Micro-Serrated)
Couteau Table (Micro-Cranté) //
Coltello Tavola (Micro-Seghettato)
Faca Mesa (Micro-Perolado)

	Caja	Box	Boîte	Scatola	Caixa
	Acero Inoxidable 18/10	Stainless Steel 18/10	Acier Inoxydable 18/10	Acciaio Inossidabile 18/10	Aço Inoxidável 18/10



560100



Cuchara Moka // Mocca Spoon
Cuillère Moka // Cucchiaino Moka
Colher Moka



560500



Cuchara Helado // Ice Cream Spoon
Cuillère à Glace // Paletta Gelato // Colher Gelado



560300

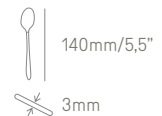

Cuchara Café // Coffee Spoon
Cuillère Café // Cucchiaino Caffè
Colher Café



560700



Cuchara Postre // Dessert Spoon
Cuillère Dessert // Cucchiaino Frutta // Colher Sobremesa



561000



Cuchara Mesa // Table Spoon
Cuillère Table // Cucchiaino Tavola
Colher mesa

	Caja	Box	Boîte	Scatola	Caixa
	Acero Inoxidable 18/10	Stainless Steel 18/10	Acier Inoxydable 18/10	Acciaio Inossidabile 18/10	Aço Inoxidável 18/10



561600



Cacillo Salsa // Gravy Ladle
Louche à Crème // Mestolo Salsa
Concha Molho



562100

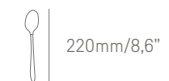

Cuchara Refresco // Iced
Tea Spoon // Cuillère à Glace
Cucchiaino Tè // Colher Refresco



561800

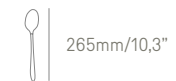

Cuchara Servir // Serving Spoon
Cuillère Service // Cucchiainone
Servire // Colher Servir



562000

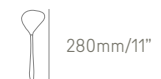

Cazo Sopa // Soup Ladle
Louche // Mestolo // Concha Sopa



561900

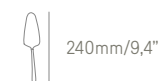

Pala Pastel // Cake Server // Pelle
à Tarte // Pala Torta // Pá Torta

	Caja	Box	Boîte	Scatola	Caixa
	Acero Inoxidable 18/10	Stainless Steel 18/10	Acier Inoxydable 18/10	Acciaio Inossidabile 18/10	Aço Inoxidável 18/10



560400



Tenedor Lunch // Cake Fork
Fourchette Lunch // Forchetta
Frutta // Garfo Lunch



560800

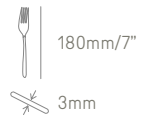

Tenedor Postre // Dessert Fork
Fourchette Dessert // Forchettina
Dolce // Garfo Sobremesa



561300

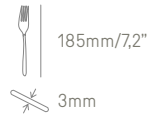

Tenedor Pescado // Fish Fork
Fourchette Poisson // Forchettina
Pesce // Garfo Peixe



561100



Tenedor Mesa // Table Fork
Fourchette Table // Forchetta
Tavola // Garfo Mesa



561700

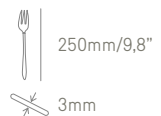

Tenedor Servir // Serving Fork
Fourchette Service // Forchettone
Servire // Garfo Servir

	Estuche 5609. Acero Inoxidable 5603, 5610, 5611, Acero Inoxidable 18/10	Gift Case 5609. Stainless Steel 5603, 5610, 5611, Stainless Steel 18/10	Ménagère 5609. Acier Inoxydable 5603, 5610, 5611, Acier Inoxydable 18/10	Confezione Regalo 5609. Acciaio Inossidabile 5603, 5610, 5611, Acciaio Inossidabile 18/10	Caixa de Presente 5609. Aço Inoxidável 5603, 5610, 5611, Aço Inoxidável 18/10
--	---	---	--	---	---

- 6 X 5609
- 6 X 5610
- 6 X 5611
- 6 X 5603

24



562400

Estuche 24 Piezas // 24 Pc. Set
Ménagère 24 Pièces // Confezione 24 Pezzi
Conjunto 24 Peças

	Maletín 5609, 5602, 5612. Acero Inoxidable 5610, 5611, 5603, 5604, 5601, 5612, 5613, 5620, 5618, 5617, 5616, 5619. Acero Inoxidable 18/10	Gift Case 5609, 5602, 5612. Stainless Steel 5610, 5611, 5603, 5604, 5601, 5612, 5613, 5620, 5618, 5617, 5616, 5619. Stainless Steel 18/10	Ménagère 5609, 5602, 5612. Acier Inoxydable 5610, 5611, 5603, 5604, 5601, 5612, 5613, 5620, 5618, 5617, 5616, 5619. Acier Inoxydable 18/10	Astuccio 5609, 5602, 5612. Acciaio Inossidabile 5610, 5611, 5603, 5604, 5601, 5612, 5613, 5620, 5618, 5617, 5616, 5619. Acciaio Inossidabile 18/10	Maleta 5609, 5602, 5612. Aço Inoxidável 5610, 5611, 5603, 5604, 5601, 5612, 5613, 5620, 5618, 5617, 5616, 5619. Aço Inoxidável 18/10
--	---	---	--	--	--

- 12 X 5609
- 12 X 5610
- 12 X 5611
- 12 X 5602
- 12 X 5603
- 12 X 5604
- 12 X 5601
- 12 X 5612
- 12 X 5613
- 1 X 5620
- 1 X 5618
- 1 X 5617
- 1 X 5616
- 1 X 5619

113



562500

Maletín 113 Piezas // 113 pc. Gift Case
Ménagère 113 pièces // Astuccio 113 Pezzi
Conjunto 113 Peças





SERIE TOSCANA

Una serie que define la sencillez y elegancia, aportando distinción natural a cualquier mesa, ideal para quienes valoran la belleza sin complicaciones.

A series that defines simplicity and elegance, adding natural distinction to any table, ideal for anyone who values uncomplicated beauty.

Une série qui définit la simplicité et l'élégance, apportant une distinction naturelle à n'importe quelle table, idéale pour ceux qui apprécient la beauté sans complication.

Una serie che definisce la semplicità e l'eleganza, fornendo una raffinatezza naturale a ogni tavola, ideale per chi apprezza la bellezza senza complicazioni.

	Caja	Box	Boîte	Scatola	Caixa
	Acero Inoxidable	Stainless Steel	Acier Inoxydable	Acciaio Inossidabile	Aço Inoxidável



570200

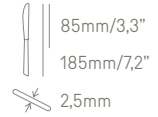

Cuchillo Lunch (Perlado) // Cake Knife (Serrated) // Couteau Lunch (Cranté) // Coltello Frutta (Seghettato) // Faca Lunch (Perolado)



570600



Cuchillo Postre (Perlado) // Dessert Knife (Serrated) // Couteau Dessert (Cranté) // Coltello Frutta (Seghettato) // Faca Sobremesa (Perolado)



570900



Cuchillo Mesa (Perlado) // Table Knife (Serrated) // Couteau Table (Cranté) // Coltello Tavola (Seghettato) // Faca Mesa (Perolado)



570902



Cuchillo Mesa (Micro-Perlado) // Table Knife (Micro-Serrated) // Couteau Table (Micro-Cranté) // Coltello Tavola (Micro-Seghettato) // Faca Mesa (Micro-Perolado)

	Caja	Box	Boîte	Scatola	Caixa
	Acero Inoxidable 18/10	Stainless Steel 18/10	Acier Inoxydable 18/10	Acciaio Inossidabile 18/10	Aço Inoxidável 18/10



570100

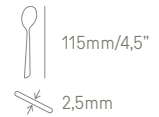

Cuchara Moka // Mocca Spoon
Cuillère Moka // Cucchiaino Moka
Colher Moka



570300



Cuchara Café // Coffee Spoon
Cuillère Café // Cucchiaino Caffè
Colher Café



570700



Cuchara Postre // Dessert Spoon
Cuillère Dessert // Cucchiaino
Frutta // Colher Sobremesa



571000



Cuchara Mesa // Table Spoon
Cuillère Table // Cucchiaino Tavola
Colher mesa



572100

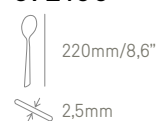

Cuchara Refresco // Iced Tea Spoon
Cuillère à Glace
Cucchiaino Tè // Colher Refresco

	Caja	Box	Boîte	Scatola	Caixa
	Acero Inoxidable 18/10	Stainless Steel 18/10	Acier Inoxydable 18/10	Acciaio Inossidabile 18/10	Aço Inoxidável 18/10



570400

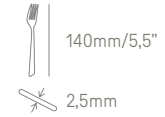

Tenedor Lunch // Cake Fork
Fourchette Lunch // Forchetta
Frutta // Garfo Lunch



570800



Tenedor Postre // Dessert Fork
Fourchette Dessert // Forchettina
Dolce // Garfo Sobremesa







571100



Tenedor Mesa // Table Fork
Fourchette Table // Forchetta
Tavola // Garfo Mesa

	Estuche	Gift Case	Ménagère	Confezione Regalo	Caixa de Presente
	5709 Acero Inoxidable NITRUM® 5703, 5710, 5711, Acero Inoxidable 18/10	5709 NITRUM® Stainless Steel 5703, 5710, 5711, Stainless Steel 18/10	5709 Acier Inoxydable NITRUM® 5703, 5710, 5711, Acier Inoxydable 18/10	5709 Acciaio Inossidabile NITRUM® 5703, 5710, 5711, Acciaio Inossidabile 18/10	5709 Aço Inoxidável NITRUM® 5703, 5710, 5711, Aço Inoxidável 18/10

-  6 X 5709
-  6 X 5710
-  6 X 5711
-  6 X 5703

24



572400

Estuche 24 Piezas // 24 Pc. Set
Ménagère 24 Pièces // Confezione 24 Pezzi
Conjunto 24 Peças

	Display	Display	Carte	Display	Display
	Acero Inoxidable	Stainless Steel	Acier Inoxydable	Acciaio Inossidabile	Aço Inoxidável



575000

110mm/4,3"
220mm/8,6"

Cuchillo Mesa (Perlado) // Table Knife (Serrated) // Couteau Table (Cranté) // Coltello Tavola (Seghettato) // Faca Mesa (Perolado)

3 X 570900



574900

90mm/3,5"
205mm/8"

Cuchillo Postre (Perlado) // Dessert Knife (Serrated) // Couteau Dessert (Cranté) // Coltello Frutta (Seghettato) // Faca Sobremesa (Perolado)

3 X 570600



578480

85mm/3,3"
185mm/7,2"

Cuchillo Lunch (Perlado) // Cake Knife (Serrated) // Couteau Lunch (Cranté) // Coltello Frutta (Seghettato) // Faca Lunch (Perolado)

3 X 570200

	Display	Display	Carte	Display	Display
	Acero Inoxidable 18/10	Stainless Steel 18/10	Acier Inoxydable 18/10	Acciaio Inossidabile 18/10	Aço Inoxidável 18/10



574700

200mm/7,8"

Tenedor Mesa // Table Fork // Fourchette Table // Forchetta Tavola // Garfo Mesa

3 X 571100



574500

180mm/7"

Tenedor Postre // Dessert Fork // Fourchette Dessert // Forchettina Dolce // Garfo Sobremesa

3 X 570800



574300

140mm/5,5"

Tenedor Lunch // Cake Fork // Fourchette Lunch // Forchetta Frutta // Garfo Lunch

6 X 570400

	Display	Display	Carte	Display	Display
	Acero Inoxidable 18/10	Stainless Steel 18/10	Acier Inoxydable 18/10	Acciaio Inossidabile 18/10	Aço Inoxidável 18/10



574100

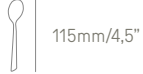

Cuchara Moka // Mocca Spoon
Cuillère Moka //Cucchiaino Moka
Colher Moka

6 X 570100



574200

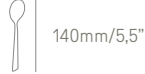

Cuchara Café // Coffee Spoon
Cuillère Café // Cucchiaino Caffè
Colher Café

6 X 570300



574400

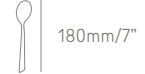

Cuchara Postre // Dessert Spoon
Cuillère Dessert // Cucchiaino
Frutta // Colher Sobremesa

6 X 570700



574600

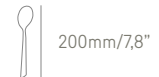

Cuchara Mesa // Table Spoon
Cuillère Table // Cucchiaino Tavola
Colher mesa

3 X 571000

SCISSORS
CISEAUX
FORBICI
TESOURAS



TIJERAS

FORGED
PÁG 220-221



ECOPRO
PÁG 222-223



PROCHEF
PÁG 224-228



DELUXE
PÁG 229-231



STYLE
PÁG 232-234





SERIE FORGED

Tijeras de cocina forjadas, perfectas para cortes de precisión. Herramientas fuertes para chefs y carniceros exigentes que valoran la durabilidad y el rendimiento.

Forged kitchen scissors, perfect for precise cuts. Strong tools for demanding chefs and butchers who value durability and performance.

Ciseaux de cuisine forgés, parfaits pour les coupes de précision. Des outils solides pour les chefs et les bouchers exigeants qui apprécient la durabilité et la performance.

Forbici da cucina forgiate, perfette per tagli di precisione. Strumenti forti per chef e macellai esigenti, che apprezzano la durevolezza e le prestazioni.

Tesouras de cozinha forjadas, perfeitas para cortes de precisão. Ferramentas fortes para chefs e carniceros exigentes que valorizam a durabilidade e o desempenho.

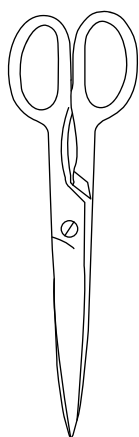

Acero Inoxidable Forjado

Forged Stainless Steel · Acier Inoxydable Forgé
Acciaio Inossidabile Forgiato · Aço Inoxidável Forjado.

Gran Potencia de Corte.

Great Cutting Power · Grande Puissance de Coupe · Grande Potenza di Taglio · Grande Poder de Corte.

Corte de Alimentos Cárnicos.

Cutting of Meat · Coupe des Aliments carnés · Taglio di Alimenti Carnosi · Corte de Alimentos Cárneos

Resistente a la Corrosión

Corrosion Resistant · Résistants à la Corrosion · Resistenti alla Corrosione · Resistentes à Corrosão.

	Funda Display - Display Sleeve - Carte - Display - Capa expositora
	Acero Inoxidable Forjado Forged Stainless Steel Acier Inoxydable Forgé Acciaio Inossidabile Forgiato Aço Inoxidável Forjado



507010

200mm/7,8"



Tijeras Cocina // Kitchen Scissors
Ciseaux Cuisine // Forbici Cucina
Tesouras Cozinha

	Funda Display - Display Sleeve - Carte - Display - Capa expositora
	Acero Inoxidable Forjado Forged Stainless Steel Acier Inoxydable Forgé Acciaio Inossidabile Forgiato Aço Inoxidável Forjado



507100

225mm/8,8"



Tijeras Cocina // Kitchen Scissors
Ciseaux Cuisine // Forbici Cucina
Tesouras Cozinha



SERIE ECOPRO

Máxima precisión en tareas especializadas. Ergonómicamente diseñadas para un rendimiento superior, adaptadas a cada tarea específica con el mínimo esfuerzo requerido.

Maximum precision in specialised jobs. Ergonomically designed for supreme performance, adapted to each specific task that requires the minimum effort.

Précision maximale dans les tâches spécialisées. Une conception ergonomique pour des performances supérieures, adaptés à chaque tâche spécifique avec un minimum d'effort requis.

Massima precisione per lavori specializzati. Progettate ergonomicamente per una resa superiore, adattate a ogni specifico lavoro al fine di applicare sempre il minimo sforzo.

Máxima precisão em tarefas especializadas. Ergonómicamente concebida para um desempenho superior, adaptada a cada tarefa específica com o mínimo esforço necessário.

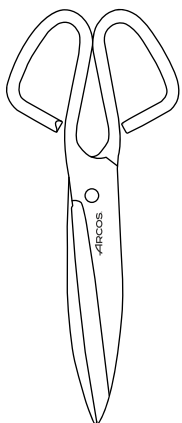

Materiales Resistentes

Resistant Materials · Matériaux résistants · Materiali Resistenti · Materiais Resistentes.

Máxima Precisión



Maximum Precision · Précision Maximale · Massima Precisione · Máxima Precisão.

Uso en Tareas Especializadas

Use in Specialized Tasks · Utilisation Dans des Tâches Spécialisées · Uso in Compiti Specializzati · Uso em Tarefas Especializadas.

Asas Ergonómicas

Ergonomic Handles · Poignées Ergonomiques · Manici Ergonomici · Cabos Ergonómicos.

	Display
	<p>Acero Inoxidable con Recubrimiento de Tungsteno Stainless Steel with Tungsten Coating Acier Inoxydable Recouvert de Tungstène Acciaio Inossidabile Ricoperto in Tungsteno Aço Inoxidável com Revestimento de Tungstênio</p> <p>Polipropileno // Polypropylene Polypropylèn // Polipropilene Polipropileno</p>



506100

145mm/5,7"



Tijeras Electricista // Electrician Shears // Ciseaux Électricien Forbici Elettricista // Tesouras Electricista

	Caja - Box - Boîte - Scatola - Caixa
	<p>Acero Inoxidable Stainless Steel Acier Inoxydable Acciaio Inossidabile Aço Inoxidável</p>



809700

200mm/7,8"



Tijeras Cocina // Kitchen Scissors Ciseaux Cuisine //Forbici Cucina Tesouras Cozinha

	Caja - Box - Boîte - Scatola - Caixa
	<p>Acero Inoxidable Stainless Steel Acier Inoxydable Acciaio Inossidabile Aço Inoxidável</p>





809800

240mm/9,4"



Tijeras Cocina // Kitchen Scissors Ciseaux Cuisine //Forbici Cucina Tesouras Cozinha

	Estuche - Case - Étui - Astuccio Estojo
	<p>Acero Inoxidable Forjado Forged Stainless Steel Acier Inoxydable Forgé Acciaio Inossidabile Forgiato Aço Inoxidável Forjado</p>





539000

250mm/9,8"



Tijeras Pollo // Poultry Shears Cisaille à Volailles Inox Trinciapollo // Tesouras Frango

	Blister
	<p>Acero Inoxidable Stainless Steel Acier Inoxydable Acciaio Inossidabile Aço Inoxidável</p> <p>Polipropileno // Polypropylene Polypropylène // Polipropilene Polipropileno</p>



539100

240mm/9,4"



Tijeras Pollo // Poultry Shears Cisaille à Volailles Inox Trinciapollo // Tesouras Frango



SERIE PROCHEF

Las tijeras PROCHEF son herramientas esenciales de cocina, con un diseño robusto y un eje de giro avanzado para máxima fuerza. Perfectas para cortar carnes y huesos, facilitando cualquier tarea culinaria.

The PROCHEF scissors are essential kitchen utensils, with a robust design and an advanced axis of rotation for maximum strength. Perfect to cut meat and bones, making any culinary task easy.

Les ciseaux PROCHEF sont des outils de cuisine essentiels, avec une conception robuste et un axe pivotant avancé pour une force maximale. Parfaits pour couper la viande et les os, facilitant ainsi toutes les tâches culinaires.

Le forbici PROCHEF sono strumenti indispensabili in cucina, grazie al design robusto e un fulcro di rotazione avanzato che consente di esercitare la massima forza. Perfette per tagliare carni e ossa, agevolano qualsiasi lavoro culinario.

As tesouras PROCHEF são um utensílio de cozinha indispensável, com um design robusto e um eixo pivotante avançado para máxima resistência. Perfeitas para cortar carne e ossos, facilitando qualquer tarefa culinária.

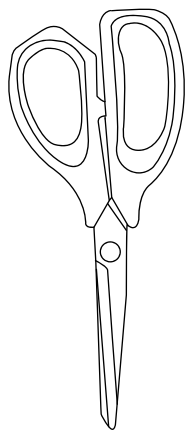

Acero Inoxidable

Stainless steel • Acier Inoxydable • Tacciaio Inossidabile
Aço Inoxidável.

Variedad de Tamaños y Colores



Variety of sizes and Colors • Variété de Tailles et de Couleurs • Varie
Dimensioni e Colori • Variedade de Tamanhos e Cores.

Uso en Tareas Especializadas

Use in Specialized Tasks • Utilisation Dans des Tâches
Spécialisées • Uso in Compiti Specializzati • Uso em Tarefas
Especializadas.

Corte de Alimentos Cárnicos

Cutting of meat • Coupe des aliments carnés • Taglio di alimenti
carnosi • Corte de alimentos cárneos

	Blister
	<p>Acero Inoxidable Stainless Steel Acier Inoxydable Acciaio Inossidabile Aço Inoxidável</p> <p>Polipropileno // Polypropylene Polypropylène // Polipropilene Polipropileno</p>



784901

195mm/7,6"



Tijeras Cocina Desmontable
Kitchen Scissors Dismountable
Ciseaux Cuisine Démontable
Forbici Cucina Smontabile
Tesoura Cozinha Desmontável

	Blister
	<p>Acero Inoxidable Stainless Steel Acier Inoxydable Acciaio Inossidabile Aço Inoxidável</p> <p>Polipropileno // Polypropylene Polypropylène // Polipropilene Polipropileno</p>



784911

195mm/7,6"



Tijeras Cocina Desmontable
Kitchen Scissors Dismountable
Ciseaux Cuisine Démontables
Forbici Cucina Smontabile
Tesoura Cozinha Desmontável

	Blister
	<p>Acero Inoxidable Stainless Steel Acier Inoxydable Acciaio Inossidabile Aço Inoxidável</p> <p>Polipropileno // Polypropylene Polypropylène // Polipropilene Polipropileno</p>



185601

215mm/8,4"



Tijeras Cocina // Kitchen Scissors
Ciseaux Cuisine //Forbici Cucina
Tesouras Cozinha

	Blister
	<p>Acero Inoxidable Stainless Steel Acier Inoxydable Acciaio Inossidabile Aço Inoxidável</p> <p>Polipropileno // Polypropylene Polypropylène // Polipropilene Polipropileno</p>





185621

215mm/8,4"



Tijeras Cocina // Kitchen Scissors
Ciseaux Cuisine //Forbici Cucina
Tesouras Cozinha

	Blister
	<p>Acero Inoxidable Stainless Steel Acier Inoxydable Acciaio Inossidabile Aço Inoxidável</p> <p>Polipropileno // Polypropylene Polypropylène // Polipropilene Polipropileno</p>





185622

215mm/8,4"



Tijeras Cocina // Kitchen Scissors
Ciseaux Cuisine // Forbici Cucina
Tesouras Cozinha

	Blister
	<p>Acero Inoxidable Stainless Steel Acier Inoxydable Acciaio Inossidabile Aço Inoxidável</p> <p>Polipropileno // Polypropylene Polypropylène // Polipropilene Polipropileno</p>





185623

215mm/8,4"



Tijeras Cocina // Kitchen Scissors
Ciseaux Cuisine // Forbici Cucina
Tesouras Cozinha

	Blister
	<p>Acero Inoxidable Stainless Steel Acier Inoxydable Acciaio Inossidabile Aço Inoxidável</p> <p>Polipropileno // Polypropylene Polypropylène // Polipropilene Polipropileno</p>





185625

215mm/8,4"



Tijeras Cocina // Kitchen Scissors
Ciseaux Cuisine // Forbici Cucina
Tesouras Cozinha

	Blister
	<p>Acero Inoxidable Stainless Steel Acier Inoxydable Acciaio Inossidabile Aço Inoxidável</p> <p>Polipropileno // Polypropylene Polypropylène // Polipropilene Polipropileno</p>





185610

215mm/8,4"



Tijeras Cocina // Kitchen Scissors
Ciseaux Cuisine // Forbici Cucina
Tesouras Cozinha

	Blister
	<p>Acero Inoxidable Stainless Steel Acier Inoxydable Acciaio Inossidabile Aço Inoxidável</p> <p>Polipropileno // Polypropylene Polypropylène // Polipropilene Polipropileno</p>





185701

235mm/9,2"



Tijeras Cocina // Kitchen Scissors
Ciseaux Cuisine // Forbici Cucina
Tesouras Cozinha

	Blister
	<p>Acero Inoxidable Stainless Steel Acier Inoxydable Acciaio Inossidabile Aço Inoxidável</p> <p>Polipropileno // Polypropylene Polypropylène // Polipropilene Polipropileno</p>



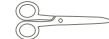

185721

235mm/9,2"



Tijeras Cocina // Kitchen Scissors
Ciseaux Cuisine // Forbici Cucina
Tesouras Cozinha

	Blister
	<p>Acero Inoxidable Stainless Steel Acier Inoxydable Acciaio Inossidabile Aço Inoxidável</p> <p>Polipropileno // Polypropylene Polypropylène // Polipropilene Polipropileno</p>





185722

235mm/9,2"



Tijeras Cocina // Kitchen Scissors
Ciseaux Cuisine // Forbici Cucina
Tesouras Cozinha

	Blister
	<p>Acero Inoxidable Stainless Steel Acier Inoxydable Acciaio Inossidabile Aço Inoxidável</p> <p>Polipropileno // Polypropylene Polypropylène // Polipropilene Polipropileno</p>





185723

235mm/9,2"



Tijeras Cocina // Kitchen Scissors
Ciseaux Cuisine // Forbici Cucina
Tesouras Cozinha

	Blister
	<p>Acero Inoxidable Stainless Steel Acier Inoxydable Acciaio Inossidabile Aço Inoxidável</p> <p>Polipropileno // Polypropylene Polypropylène // Polipropilene Polipropileno</p>



185725

235mm/9,2"



Tijeras Cocina // Kitchen Scissors
Ciseaux Cuisine // Forbici Cucina
Tesouras Cozinha

	Blister
	Acero Inoxidable Stainless Steel Acier Inoxydable Acciaio Inossidabile Aço Inoxidável
	ABS



185400

215mm/8,4"



Tijeras Cocina // Kitchen Scissors
Ciseaux Cuisine // Forbici Cucina
Tesouras Cozinha

	Blister
	Acero Inoxidable Stainless Steel Acier Inoxydable Acciaio Inossidabile Aço Inoxidável
	ABS



185500

210mm/8,2"



Tijeras Cocina // Kitchen Scissors
Ciseaux Cuisine // Forbici Cucina
Tesouras Cozinha

	Blister
	Acero Inoxidable Stainless Steel Acier Inoxydable Acciaio Inossidabile Aço Inoxidável
	ABS



186000

210mm/8,2"



Tijeras Cocina Zurdos // Kitchen
Scissors Left-Handed // Ciseaux
Cuisine Gauchers // Forbici Cucina
Mancini // Tesouras Cozinha
Canhotos



SERIE DELUXE

La serie DELUXE destaca por su polivalencia. Tijeras diseñadas para adaptarse a una variedad de usos, desde cortar tejidos delicados hasta tareas de artesanía y manualidades.

The DELUXE series is distinguished for its versatility. Scissors designed to adapt to a variety of uses, from cutting delicate fabrics to arts and crafts.

La série DELUXE se distingue par sa polyvalence. Des ciseaux conçus pour s'adapter à une variété d'utilisations, de la coupe de tissus délicats à l'artisanat et aux travaux manuels.

La serie DELUXE si distingue per la sua versatilità. Forbici progettate per adattarsi a una gran varietà di usi, dal taglio di tessuti delicati fino a lavori di artigianato e attività manuali.

A série DELUXE destaca-se pela sua versatilidade. Tesouras concebidas para se adaptar a uma variedade de utilizações, desde o corte de tecidos delicados até às tarefas de artesanato e trabalhos manuais.

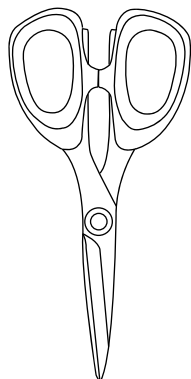

Acero Inoxidable

Stainless Steel · Acier Inoxydable · Acciaio Inossidabile
Aço Inoxidável.

Precisión de Corte

Cutting Precision · Précision de Coupe · Precisione di
Taglio · Precisão de Corte.

Diseño Característico.

Characteristic Design · Design Caractéristique
Design Caratteristico · Design Característico.

Uso en Tareas Especializadas

Use in Specialized Tasks · Utilisation Dans des Tâches
Spécialisées · Uso in Compiti Specializzati · Uso em Tarefas
Especializadas.

Resistente a la Corrosión

Corrosion Resistant · Résistants à la Corrosion · Resistenti
alla Corrosione · Resistentes à Corrosão.

	185300 Caja - Box - Boîte - Scatola - Caixa
	185301 Blister
	Acero Inoxidable Stainless Steel Acier Inoxydable Acciaio Inossidabile Aço Inoxidável
	Polipropileno // Polypropylene Polypropylène // Polipropilene Polipropileno Polipropileno





185300/185301

200mm/7,8"



Tijeras Cocina // Kitchen Scissors
Ciseaux Cuisine // Forbici Cucina
Tesouras Cozinha

	Blister
	Acero Inoxidable Stainless Steel Acier Inoxydable Acciaio Inossidabile Aço Inoxidável
	Polipropileno // Polypropylene Polypropylène // Polipropilene Polipropileno





185324

200mm/7,8"



Tijeras Cocina // Kitchen Scissors
Ciseaux Cuisine // Forbici Cucina
Tesouras Cozinha

	185900 Caja - Box - Boîte - Scatola - Caixa
	185901 Blister
	Acero Inoxidable Stainless Steel Acier Inoxydable Acciaio Inossidabile Aço Inoxidável
	Polipropileno // Polypropylene Polypropylène // Polipropilene Polipropileno





185900/185901

220mm/8,6"



Tijeras Cocina // Kitchen Scissors
Ciseaux Cuisine // Forbici Cucina
Tesouras Cozinha

	Blister
	Acero Inoxidable Stainless Steel Acier Inoxydable Acciaio Inossidabile Aço Inoxidável
	Polipropileno // Polypropylene Polypropylène // Polipropilene Polipropileno





185924

220mm/8,6"



Tijeras Cocina // Kitchen Scissors
Ciseaux Cuisine // Forbici Cucina
Tesouras Cozinha

	Caja - Box - Boîte - Scatola - Caixa
	<p>Acero Inoxidable Stainless Steel Acier Inoxydable Acciaio Inossidabile Aço Inoxidável</p> <p>ABS</p>



513500

135mm/5,3"



Tijeras Costura // Sewing Scissors
Ciseaux Couture // Forbici Sartoria
Tesouras Costura

	Caja - Box - Boîte - Scatola - Caixa
	<p>Acero Inoxidable Stainless Steel Acier Inoxydable Acciaio Inossidabile Aço Inoxidável</p> <p>ABS</p>



516500

165mm/6,4"



Tijeras Costura // Sewing Scissors
Ciseaux Couture // Forbici Sartoria
Tesouras Costura

	Caja - Box - Boîte - Scatola - Caixa
	<p>Acero Inoxidable Stainless Steel Acier Inoxydable Acciaio Inossidabile Aço Inoxidável</p> <p>ABS</p>



521000

210mm/8,2"

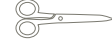

Tijeras Costura // Sewing Scissors
Ciseaux Couture // Forbici Sartoria
Tesouras Costura



SERIE STYLE

Tijeras especializadas en costura y manicura, indispensables en el mundo de la moda y el cuidado personal. Su corte preciso y diseño ergonómico las convierten en un añadido esencial para cualquier casa.

Specialised sewing and manicure scissors, indispensable in the world of fashion and personal care. Their precise cut and ergonomic design make them an essential for any home.

Des ciseaux spécialisés pour la couture et la manucure, indispensables dans le monde de la mode et des soins personnels. Leur coupe précise et leur conception ergonomique en font un complément essentiel dans tous les foyers.

Forbici specifiche per il cucito e la manicure, indispensabili nel mondo della moda e dell'igiene personale. Il loro taglio preciso e il design ergonomico le rendono un accessorio indispensabile in ogni casa.

Tesouras especializadas em costura e manicura, indispensáveis no mundo da moda e dos cuidados pessoais. O seu corte preciso e o seu design ergonómico fazem delas um complemento indispensável em qualquer casa.

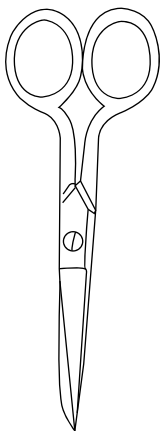

Acero Inoxidable Forjado

Forged Stainless Steel · Acier Inoxydable Forgé
Acciaio Inossidabile Forgiato · Aço Inoxidável Forjado.

Peso Ligero

Lightweight · Poids léger · Peso leggero · Peso leve.

Uso en Tareas Especializadas

Use in Specialized Tasks · Utilisation Dans des Tâches Spécialisées · Uso in Compiti Specializzati · Uso em Tarefas Especializadas.

Máxima Precisión

Maximum Precision · Précision Maximale · Massima Precisione · Máxima Precisão.

	Blister
	<p>Acero Inoxidable Forjado Forged Stainless Steel Acier Inoxydable Forgé Acciaio Inossidabile Forgiato Aço Inoxidável Forjado</p> <p>Niqueladas // Nickel Plated Nickel Nichelati // Niqueladas</p>



502200

127mm/5"



Tijeras Costura Castellana
Sewing Scissors Castellana Style
Ciseaux de Couture Le Castillan
Forbici sartoria Castigliana
Tesouras Costura Castelhana

	Blister
	<p>Acero Inoxidable Forjado Forged Stainless Steel Acier Inoxydable Forgé Acciaio Inossidabile Forgiato Aço Inoxidável Forjado</p> <p>Niqueladas // Nickel Plated Nickel Nichelati // Niqueladas</p>



502300

140mm/5,5"



Tijeras Costura Castellana
Sewing Scissors Castellana Style
Ciseaux de Couture Le Castillan
Forbici sartoria Castigliana
Tesouras Costura Castelhana

	Blister
	<p>Acero Inoxidable Forjado Forged Stainless Steel Acier Inoxydable Forgé Acciaio Inossidabile Forgiato Aço Inoxidável Forjado</p> <p>Niqueladas // Nickel Plated // Nickel Nichelati // Niqueladas</p>



502400

152mm/5,9"



Tijeras Costura Castellana
Sewing Scissors Castellana Style
Ciseaux de Couture Le Castillan
Forbici sartoria Castigliana
Tesouras Costura Castelhana

	Blister
	<p>Acero Inoxidable Forjado Forged Stainless Steel Acier Inoxydable Forgé Acciaio Inossidabile Forgiato Aço Inoxidável Forjado</p> <p>Niqueladas // Nickel Plated // Nickel Nichelati // Niqueladas</p>



500600

102mm/4"



Tijeras de Manicura Curva // Manicure Scissors Curved
Ciseaux à Ongles Lame Coyrbée
Forbici Unghie Lama Curva
Tesouras Manicure Curva

	Blister
	<p>Acero Inoxidable Forjado Forged Stainless Steel Acier Inoxydable Forgé Acciaio Inossidabile Forgiato Aço Inoxidável Forjado</p> <p>Niqueladas // Nickel Plated // Nickel Nichelati // Niqueladas</p>



501100

102mm/4"



Tijeras de Uñas Recta // Nail Scissors Straight // Ciseaux à Ongles Lame Droite // Forbici Unghie Lama Diritta // Tesouras Manicure Reta

	Blister
	<p>Acero Inoxidable Forjado Forged Stainless Steel Acier Inoxydable Forgé Acciaio Inossidabile Forgiato Aço Inoxidável Forjado</p> <p>Niqueladas // Nickel Plated // Nickel Nichelati // Niqueladas</p>



504200

178mm/7"



Tijeras de Modista // Dressmaker Shears // Ciseaux de Couturier
Forbici Sarto Abiti // Tesouras Costureira

	Blister
	<p>Acero Inoxidable Forjado Forged Stainless Steel Acier Inoxydable Forgé Acciaio Inossidabile Forgiato Aço Inoxidável Forjado</p> <p>Niqueladas // Nickel Plated // Nickel Nichelati // Niqueladas</p>



504300

190mm/7,4"



Tijeras de Modista // Dressmaker Shears // Ciseaux de Couturier
Forbici Sarto Abiti // Tesouras Costureira

1. Crescent // Demi-lune // Mezzaluna // Meia-lua
2. Intermediate Point // Point Intermédiaire // Punto Medio // Ponto intermédio
3. Point // Pointe // Punta // Ponta
4. Sharp Blade // Lame Pointue // Lama Appuntita // Lâmina pontiaguda
5. Blade // Lame // Lama // Lâmina
6. Bevel // Tranchant // Fio
7. Back // Dos // Dorso
8. Belt // Ceinture // Cintura // Cinturão
9. Dorsal Bevel // Biseau Dorsal // Bisello Dorsale // Bisel Dorsal
10. Board Snap // Joint d'assemblage // Giunto ad Incastro // Ponto Intermédio
11. Snap Closure // Fermeture d'assemblage G // Chiusura a Incastro G // Fecho de encaixe G
12. Area Between Leaf and Eye // Zone entre la Lame et l'œil // Zona fra Lama e Occhio // Área entre lâmina e anel
13. Closing a Snap // Fermeture d'assemblage A // Chiusura dell'Incastro A // Fecho de encaixe A
14. Rome Blade // Lame Arrondie // Lama Roma // Lâmina Roma
15. Interior Face // Face Intérieure // Lato Inferiore // Face interior
16. Screw // Vis // Vite // Parafuso
17. Box // Caisse // Scatola // Caixa
18. Brand Stamp // Marque // Marca // Marca
19. Printing // Estampage Distinctif // Stampa Differenziatrice // Estampado Diferenciador
20. Eye // Oeil // Occhio // Anel
21. Singing Eye // Chant de l'œil // Bordo dell'Occhio // Canto do anel

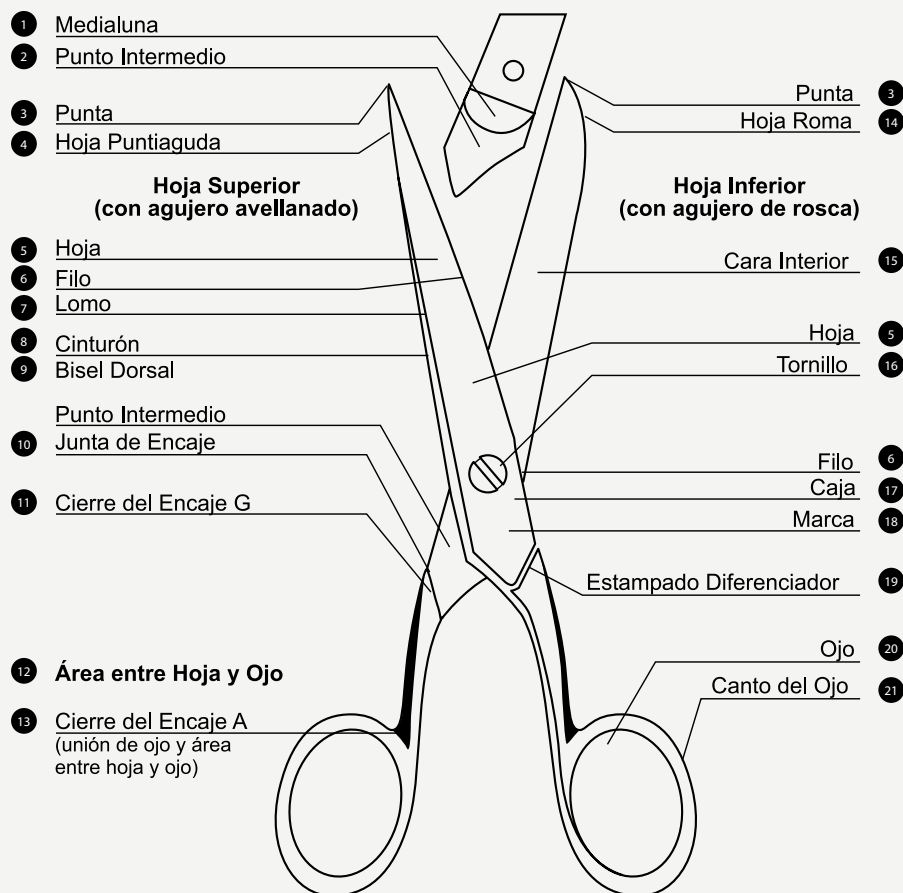



COOKWARE
POÊLES ET CASSEROLES
PADELLE E CASSERUOLE
CAÇAROLA

SARTENES Y
CACEROLAS

SAMOA
PÁG 238-245



THERA
PÁG 246-253



KAULA
PÁG 254-259





SERIE SAMOA

Acércate al mundo profesional culinario de la mano de esta serie creada con un diseño funcional y unas prestaciones únicas. Arrasa, deslumbra... aviva tu naturaleza. Atrévete a brillar.

Get closer to the professional culinary world with this series created with a functional design and unique features. Make a statement, dazzle... inspire yourself. Dare to shine.

Rejoignez le monde de la cuisine professionnelle avec cette gamme dotée d'une conception fonctionnelle et d'un ensemble de prestations uniques. Faites des ravages, éblouissez les vôtres... faites ressortir votre propre nature. Osez briller.

Avvicinatevi al mondo dei professionisti culinari grazie a questa serie, creata in base a un design funzionale e a delle prestazioni uniche. Spiccate, sorprendete...accentuate la vostra natura. Arrischiatevi a brillare.

Aproxime-se do mundo da cozinha profissional com esta série criada com um design funcional e características únicas. Arrasa, deslumbra... anima a sua natureza. Atreva-se a brilhar.

FORGED ALUMINIUM

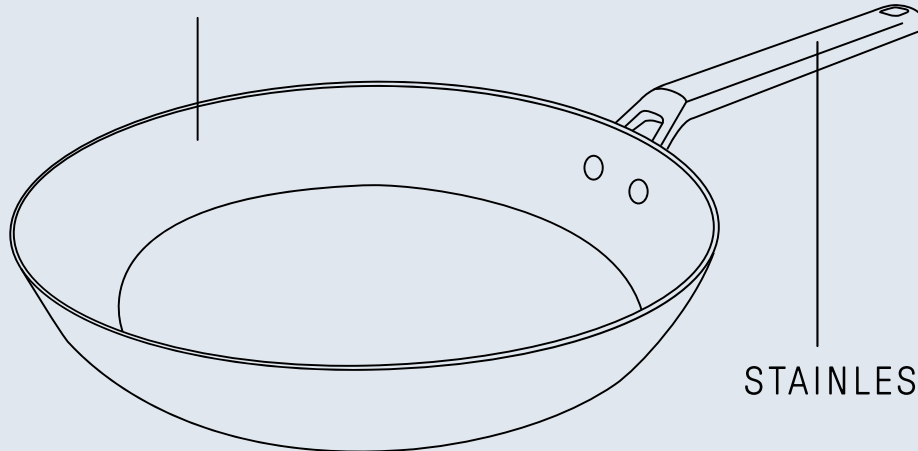

STAINLESS STEEL



Eclipse™

Hard reinforced non-stick coating

Eclipse® es una marca comercial registrada de Whitford



Libre de PFOA // Free PFOA // Sans PFOA // Senza PFOA // Livre de PFOA



Ahorro energético // Energy saving
Économie d'énergie // Risparmio Energetico // Economia de Energia



Con reparto Uniforme del Calor
Saving with Uniform Heat Distribution.
Avec une Répartition Uniforme de la Chaleur.
Con Distribuzione Uniforme del Calore.
Com Distribuição Uniforme do Calor.

Cuerpo de aluminio forjado. Asas y mangos remachados de acero inoxidable efecto frío. Apta para todo tipo de cocinas. Sistema de ahorro energético. Fácil limpieza interior y exterior. Apta para el lavavajillas.

Forged aluminium body. Cold riveted stainless steel handles and grips. Internally reinforced non-stick system. Suitable for all kinds of kitchens. Energy saving system. Easy internal and external cleaning. Dishwasher safe.

Corps en aluminium forgé. Poignées et manches à rivets en inox effet froid. Revêtement antiadhésif renforcé. Compatible tous feux. Montée en température rapide. Nettoyage facile, intérieur et extérieur.

Corpo in alluminio forgiato. Anse e manici rivettati in acciaio inossidabile effetto freddo. Sistema antiaderente rinforzato internamente. Indicata per qualsiasi tipo di cucina. Sistema di risparmio energetico. Facile pulizia interna ed esterna. Indicata per lavaggio in lavastoviglie.

Corpo em alumínio forjado. Asas e cabos rebitados em aço inoxidável de efeito frio. Adequado para todos os tipos de fogões. Sistema de poupança energética. Fácil limpeza interior e exterior. Apto para máquina de lavar loiça. Alumínio forjado



Recubrimiento Antiadherente
Non Stick Coating
Revêtement Antiadhésif
Rivestimento Antiaderente
Revestimento Antiaderente



Aluminio forjado
Forged Aluminium
Aluminium Forgé
Alluminio Forgiato
Alumínio Forjadot



Cocinas de Gas // Gas Cooktops
Cuisinières à Gaz // Cucine a Gas
Fogão a gás



Inducción // Induction
Induction // Induzione
Indução



Cocinas de Eléctricas // Electric Cooktops // Cuisinières Électriques
Cucine Elettriche // Fogões Elétricos



Apto para Lavavajillas
Dishwasher Proof // Adapté Au Lave-Vaisselle // Adatto per il Lavaggio in Lavastoviglie // Adequado para Lava-louças



Cocinas de Ceramicas // Ceramic Cooktops // Cuisinières Céramiques
Cucine Ceramiche // Fogões Cerâmicos

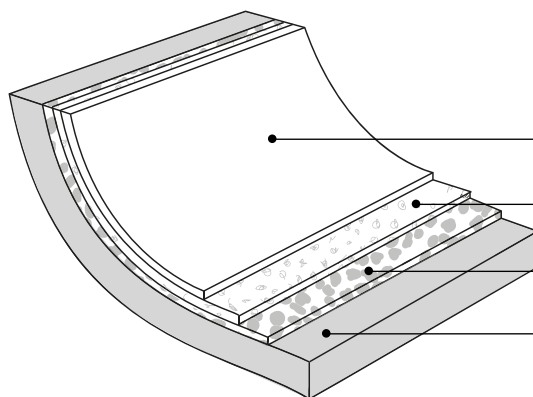

Capa superior con una anti-adherencia premium
Premium release topcoat

Capa media parcialmente reforzada
Partially reinforced midcoat

Capa primera altamente reforzada
Heavily reinforced primer

Base de aluminio forjado
Metal substrate



EXCELLENT RELEASE



SUPERIOR DURABILITY



MADE WITHOUT PFOA



MADE WITHOUT PFOS



REGULATORY COMPLIANT



SCRATCH RESISTANT



DISHWASHER SAFE



HEALTHFUL COOKING



EASY CLEAN

[ECLIPSE™] is a trademark of PPG Industries Ohio, Inc., used with permission. © 2020 PPG Industries, Inc. All rights reserved.



Corbata

Sleeve

Fourreau Carton

Cartone Protettivo

Gravata Cartão



18 cm

716010



Sartén Antiadherente // Non-Stick Fry Pan // Poêle Anti-adhésive Padella Antiaderente // Frigideira Antiaderente



20 cm

716110



Sartén Antiadherente // Non-Stick Fry Pan // Poêle Anti-adhésive Padella Antiaderente // Frigideira Antiaderente



22 cm

716210



Sartén Antiadherente // Non-Stick Fry Pan // Poêle Anti-adhésive Padella Antiaderente // Frigideira Antiaderente



24 cm

716310



Sartén Antiadherente // Non-Stick Fry Pan // Poêle Anti-adhésive Padella Antiaderente // Frigideira Antiaderente

	Corbata	Sleeve	Fourreau Carton	Cartone Protettivo	Gravata Cartão
---	---------	--------	-----------------	--------------------	----------------



26 cm

716410



Sartén Antiadherente // Non-Stick Fry Pan // Poêle Anti-adhésive Padella Antiaderente // Frigideira Antiaderente



28 cm

716510



Sartén Antiadherente // Non-Stick Fry Pan // Poêle Anti-adhésive Padella Antiaderente // Frigideira Antiaderente



30 cm

716610



Sartén Antiadherente // Non-Stick Fry Pan // Poêle Anti-adhésive Padella Antiaderente // Frigideira Antiaderente



32 cm

716710



Sartén Antiadherente // Non-Stick Fry Pan // Poêle Anti-adhésive Padella Antiaderente // Frigideira Antiaderente

	Caja	Box	Boîte	Scatola	Caixa
--	------	-----	-------	---------	-------



16cm/1,5L

716810

 16cm/6,2"

Cacerola // Casserole // Sauteuse
Casseruola // Caçarola



20cm/2,6L

716910

 20cm/7,8"

Cacerola // Casserole // Sauteuse
Casseruola // Caçarola



24cm/4,3L

717010

 24cm/9,4"

Cacerola // Casserole
Sauteuse // Casseruola
Caçarola



28cm/4,3L

717110

 28cm/11"

Cacerola // Casserole // Sauteuse
Casseruola // Caçarola

	Corbata	Sleeve	Fourreau Carton	Cartone Protettivo	Gravata Cartão
---	---------	--------	-----------------	--------------------	----------------



16cm/1,5L

717210



Cazo // Sauce Pan // Casserole
Padella // Caçarola Com Rabo



20cm/2,6L

717310



Cazo // Sauce Pan // Casserole
Padella // Caçarola Com Rabo



28x28 cm

717410



Grill Antiaderente // Non-Stick
Grill // Gril Anti-Adhésif // Grill
Antiaderente // Grelhador
Antiaderente



28 cm

717510



Wok Antiaderente // Non-Stick
Wok // Wok Anti-Adhésive
Wok Antiaderente // Wok
Antiaderente

	Corbata	Sleeve	Fourreau Carton	Cartone Protettivo	Gravata Cartão
--	---------	--------	-----------------	--------------------	----------------



20-24 cm

717810

 20cm-24/7,8-9,4"

Set de sartenes // 2 Frying Pan
 Set // Set 2 Poêle // Set 2 Padelle
 Set 2 Frigideiras

	Caja	Box	Boîte	Scatola	Caixa
---	------	-----	-------	---------	-------



NEW

x5

697500

Bateria de Cocina // Cookware Set
 Batterie de Cuisine // Batteria da
 Cucina // Conjunto de Panelas

5 Piezas // 5 Pieces // 5 Pezzi
 5 Pezzi // 5 peças

 **717210**
 16cm/6,2"

 **716810**
 16cm/6,2"

 **716910**
 20cm/7,8"

 **717010**
 24cm/9,4"

 **717110**
 28cm/11"





SERIE THERA

Descubre una serie diseñada para quien se atreva a explorar su máximo potencial. Un acabado superior que imprimirá un plus de personalidad a tus creaciones. Una experiencia insuperable.

A series designed for those who have the courage to explore their fullest potential. A superior finish which will add personality to one's creations. An unsurpassable experience.

Une collection pensée pour ceux qui sont prêts à explorer pleinement leur potentiel. Avec une finition haut de gamme qui donnera une touche de personnalité sans égal à vos créations. Une expérience exceptionnelle.

Scoprite una serie progettata per chi si arrischia a esplorare fino in fondo le proprie potenzialità. Una finitura superiore, che darà un tocco aggiuntivo di personalità alle vostre creazioni. Un'esperienza insuperabile.

Descubra uma série concebida para aqueles que se atrevem a explorar todo o seu potencial. Um acabamento superior que irá dar às suas criações um toque extra de personalidade. Uma experiência insuperável.

CAST ALUMINUM

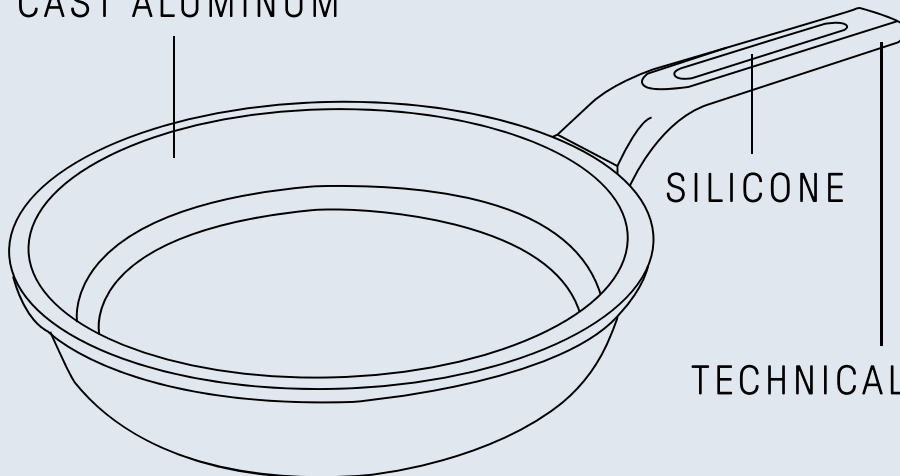

SILICONE

TECHNICAL PLASTIC



Eclipse™

Hard reinforced non-stick coating

Eclipse® es una marca comercial registrada de Whitford



Libre de PFOA // Free PFOA // Sans PFOA // Senza PFOA // Livre de PFOA



Ahorro energético // Energy Saving
Économie d'énergie // Risparmio Energetico // Economia de Energia



Con reparto uniforme del calor
Saving with Uniform Heat Distribution.
Avec une Répartition Uniforme de la Chaleur.
Con Distribuzione Uniforme del Calore.
Com Distribuição Uniforme do Calor.

Cuerpo de aluminio fundido. Mangos ergonómicos de plástico y silicona. Asas de aluminio fundido con protectores de silicona incluidos. Sistema antiadherente reforzado internamente. Apta para todo tipo de cocinas. Sistema de ahorro energético. Fácil limpieza interior y exterior. Apta para el lavavajillas.

Cast aluminium body. Ergonomic plastic and silicone handles. Cast aluminium handles with silicone protectors included. Internally reinforced non-stick system. Suitable for all types of kitchens. Energy saving system. Easy internal and external cleaning. Dishwasher safe.

Corps en fonte d'aluminium. Manches ergonomiques en plastique et en silicone. Poignées en fonte d'aluminium, livré avec protections en silicone. Système antiadhésif renforcé intérieurement. Adapté à toutes les cuisinières. Système d'épargne énergétique. Intérieur et extérieur faciles à nettoyer. Adapté au lave-vaisselle.

Corpo in alluminio fuso. Manici ergonomici in plastica e silicone. Anse di alluminio fuso, protezioni in silicone comprese. Sistema antiaderente rinforzato internamente. Indicata per qualsiasi tipo di cucina. Sistema di risparmio energetico. Facile pulizia interna ed esterna. Indicata per il lavaggio in lavastoviglie.

Corpo de alumínio fundido. Pegas ergonómicas de plástico e silicone. Alças de alumínio fundido com protetores de silicone incluídos. Sistema antiaderente reforçado internamente. Adequada para todos os tipos de cozinhas. Sistema de economia de energia. Fácil limpeza interna e externa. Adequada para máquina de lavar louça.



Antiadherente Reforzado
Reinforced Non Stick Coating
Antiadhésif Renforcé
Antiaderente Rinforzato
Antiaderente Reforçado



Aluminio Fundido
Die Cast Aluminium
Fonte D'Aluminium
Alluminio Fuso
Alumínio Fundido



Cocinas de Gas // Gas Cooktops
Cuisinières à Gaz // Cucine a Gas
Fogão a Gás



Inducción // Induction
Induction // Induzione
Indução



Cocinas de Eléctricas // Electric Cooktops
Cuisinières Électriques
Cucine Elettriche // Fogões Elétricos.



Apto para Lavavajillas
Dishwasher Proof // Adapté Au Lave-Vaisselle // Adatto per il Lavaggio in Lavastoviglie
Adequado Para Lava-Louças



Cocinas de Ceramics // Ceramic Cooktops
Cuisinières Céramiques
Cucine Ceramiche // Fogões Lerâmicos

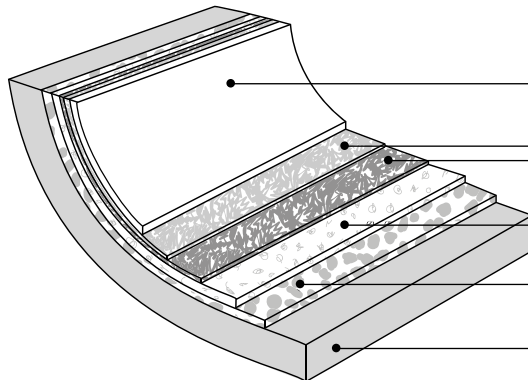

Capa superior con una anti-adherencia premium
Premium release topcoat

Capas media reforzadas
Spatter reinforcement

Capa intermedia de refuerzo
Partially reinforced midcoat

Capa primera altamente reforzada
Heavily reinforced prime coat

Base de aluminio fundido
Metal substrate



EXCELLENT RELEASE



SUPERIOR DURABILITY



MADE WITHOUT PFOA



MADE WITHOUT PFOS



REGULATORY COMPLIANT



SCRATCH RESISTANT



DISHWASHER SAFE



HEALTHFUL COOKING



EASY CLEAN

[ECLIPSE™] is a trademark of PPG Industries Ohio, Inc., used with permission. © 2020 PPG Industries, Inc. All rights reserved.

	Corbata	Sleeve	Fourreau Carton	Cartone Protettivo	Gravata Cartão
--	---------	--------	-----------------	--------------------	----------------



16 cm

718000

 16cm/6,2"

Sartén Antiaderente // Non-Stick Fry Pan // Poêle-Antiadhésive Padella Antiaderente // Frigideira Antiaderente



18 cm

718100

 18cm/7"

Sartén Antiaderente // Non-Stick Fry Pan // Poêle-Antiadhésive Padella Antiaderente // Frigideira Antiaderente



20 cm

718200

 20cm/7,8"

Sartén Antiaderente // Non-Stick Fry Pan // Poêle-Antiadhésive Padella Antiaderente // Frigideira Antiaderente



22 cm

719800

 22cm/8,6"

Sartén Antiaderente // Non-Stick Fry Pan // Poêle-Antiadhésive Padella Antiaderente // Frigideira Antiaderente

	Corbata	Sleeve	Fourreau Carton	Cartone Protettivo	Gravata Cartão
---	---------	--------	-----------------	--------------------	----------------



24 cm

718300

 24cm/9,4"

Sartén Antiadherente // Non-Stick Fry Pan // Poêle-Antiadhésive Padella Antiaderente // Frigideira Antiaderente



26 cm

718400

 26cm/10,2"

Sartén Antiadherente // Non-Stick Fry Pan // Poêle-Antiadhésive Padella Antiaderente // Frigideira Antiaderente



28 cm

718500

 28cm/11"

Sartén Antiadherente // Non-Stick Fry Pan // Poêle-Antiadhésive Padella Antiaderente // Frigideira Antiaderente



30 cm

718600

 30cm/11,8"

Sartén Antiadherente // Non-Stick Fry Pan // Poêle-Antiadhésive Padella Antiaderente // Frigideira Antiaderente

	Corbata	Sleeve	Fourreau Carton	Cartone Protettivo	Gravata Cartão
--	---------	--------	-----------------	--------------------	----------------



16cm/1,2L

719000



**Cazo // Sauce Pan // Casserole
Padella // Caçarola Com Rabo**



18cm/1,6L

719100



**Cazo // Sauce Pan // Casserole
Padella // Caçarola Com Rabo**



20cm/2,2L

719200



**Cazo // Sauce Pan // Casserole
Padella // Caçarola Com Rabo**

	Caja	Box	Boîte	Scatola	Caixa
---	------	-----	-------	---------	-------



24cm/4L

718700



**Cacerola // Casserole // Faitout
Casseruola // Caçarola Com Rabo**



24cm/4L

718800



**Cacerola // Casserole // Faitout
Casseruola // Caçarola Com Rabo**



24cm/4L

718900



**Cacerola // Casserole // Faitout
Casseruola // Caçarola Com Rabo**

	Corbata	Sleeve	Fourreau Carton	Cartone Protettivo	Gravata Cartão
---	---------	--------	-----------------	--------------------	----------------



24x24cm

719300



Grill Antiaderente // Non-Stick Grill // Gril Anti-Adhésif // Grill Antiaderente // Grelhador Antiaderente



28x28cm

719400



Grill Antiaderente // Non-Stick Grill // Gril Anti-Adhésif // Grill Antiaderente // Grelhador Antiaderente

	Caja	Box	Boîte	Scatola	Caixa
--	------	-----	-------	---------	-------



34x26cm

719500

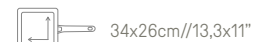

Grill Antiaderente // Non-Stick Grill // Gril Anti-Adhésif // Grill Antiaderente // Grelhador Antiaderente



719600

8,5x6,5cm/3,3x2,5"

719700

10x7cm/3,9x2,7"

Asas Silicona (1 par) // Silicone Handles (1 pair) // Poignées Silicone (1 paire) // Manice Silicone (1 paio) // Asas Silicone (1Par)

	Corbata	Sleeve	Fourreau Carton	Cartone Protettivo	Gravata Cartão
--	---------	--------	-----------------	--------------------	----------------



20-24 cm

7198000

 20-24cm/7,8-9,4"

Set de sartenes // Frying Pan Set
Set 2 Poêle // Set 2 Padelle // Set
2 Frigideiras

	Caja	Box	Boîte	Scatola	Caixa
---	------	-----	-------	---------	-------



NEW

x4

697900

Bateria de Cocina // Cookware Set
Batterie de Cuisine // Batteria da
Cucina // Conjunto de Panelas

4 Piezas // 4 Pieces // 4 Pièces
4 Pezzi // 4peças

 **719100**
18/7"

 **718700**
24cm/9,4"

 **718800**
28cm/11"

 **719500**
34x26cm//13,3x11"



ARCOS®
MADE IN ALBACETE, SPAIN

NITRUM® Stainless Steel
1914 170mm (7")



SERIE KAULA

Es el momento de dejarte llevar. Enciende tu chispa con esta serie diseñada para que te muevas con soltura en el mundo de la cocina. Destapa tu pasión.

It's time to let yourself go. Ignite your spark with this series designed to make you feel right at home in the world of amateur cooking. Unleash your passion.

È le temps de lâcher prise. Faites resplendir votre talent avec cette collection conçue pour vous mettre à l'aise dans l'univers de la cuisine. Laissez s'exprimer votre passion.

È il momento di lasciarsi andare. Accendete la vostra scintilla, grazie a questa serie progettata per muoversi disinvoltamente nel mondo della cucina. Fate esplodere la vostra passione.

É tempo de se deixar levar. Acenda a sua fâisca com esta série concebida para que se mova com facilidade no mundo da cozinha. Liberte a sua paixão.

FORGED ALUMINIUM

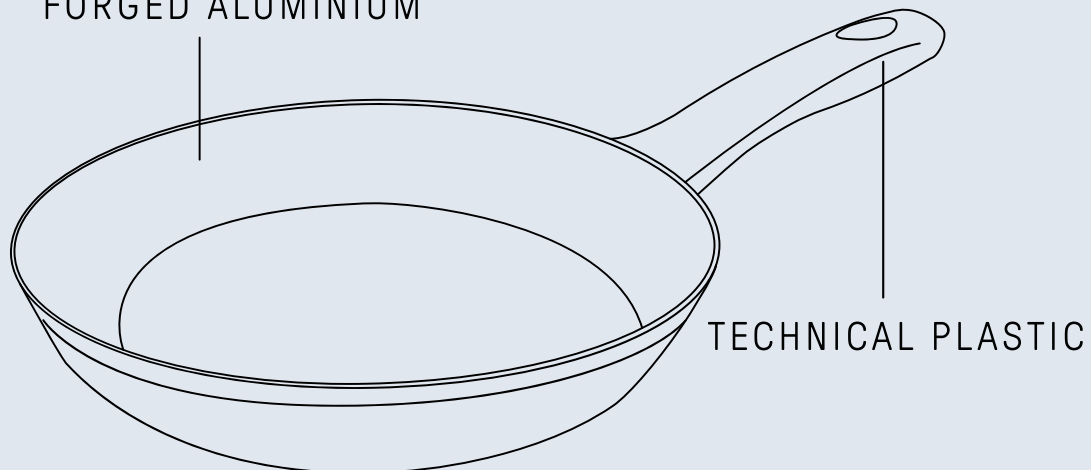

TECHNICAL PLASTIC



QuanTanium™
Titanium-reinforced non-stick coating



Libre de PFOA // Free PFOA // Sans PFOA // Senza PFOA // Livre de PFOA



Ahorro energético // Energy saving
Économie d'énergie // Risparmio Energetico // Economia de Energia



Con reparto uniforme del calor
Saving with uniform heat distribution.
Avec une répartition uniforme de la chaleur.
Con distribuzione uniforme del calore.
Com distribuição uniforme do calor.

QuanTanium® es una marca comercial registrada de Whitford

Recubrimiento antiadherente multicapa reforzado con partículas de Titanio. Su superficie antiadherente libre de PFOA está indicada para el contacto alimentario. Distribución uniforme del calor en el área de cocción, evitando que los alimentos se quemen y asegurando una cocción perfecta. Fabricado con aluminio forjado, un material de gran dureza y durabilidad.

Multi-layer non-stick coating reinforced with Titanium particles. Its PFOA-free non-stick surface is suitable for food contact. Ensures uniform heat distribution in the cooking area, preventing food from burning and guaranteeing perfect cooking. Made with forged aluminum, a material of great hardness and durability.

Revêtement antiadhésif multicouche renforcé de particules de Titane. Sa surface antiadhésive sans PFOA est adaptée au contact alimentaire. Distribution uniforme de la chaleur dans la zone de cuisson, évitant que les aliments ne brûlent et assurant une cuisson parfaite. Fabriqué en aluminium forgé, un matériau de grande dureté et durabilité.

Rivestimento antiaderente multistrato rinforzato con particelle di Titanio. La sua superficie antiaderente priva di PFOA è adatta al contatto alimentare. Distribuzione uniforme del calore nell'area di cottura, impedendo agli alimenti di bruciare e garantendo una cottura perfetta. Realizzato in alluminio forgiato, un materiale di grande durezza e durata.

Revestimento antiaderente multicamadas reforçado com partículas de Titânio. Sua superfície antiaderente livre de PFOA é adequada para contato com alimentos. Distribuição uniforme de calor na área de cozimento, evitando que os alimentos queimem e garantindo um cozimento perfeito. Fabricado com alumínio forjado, um material de grande dureza e durabilidade.



Recubrimiento Antiadherente
Non stick Coating
Revêtement Antiadhésif
Rivestimento Antiaderente
Revestimento Antiaderente



Aluminio forjado
Forged Aluminium
Aluminium Forgé
Alluminio Forgiato
Alumínio Forjadot



Cocinas de Gas // Gas Cooktops
Cuisinières à Gaz // Cucine a Gas
Fogão a gás



Inducción // Induction
Induction // Induzione
Indução



Cocinas de Eléctricas // Electric Cooktops
Cuisinières Électriques
Cucine Elettriche // Fogões Elétricos



Apto para Lavavajillas
Dishwasher Proof // Adapté
Au Lave-Vaisselle // Adatto
per il Lavaggio in Lavastoviglie
Adequado para Lava-louças



Cocinas de Ceramicas // Ceramic Cooktops
Cuisinières Céramiques
Cucine Ceramiche // Fogões Cerâmicos

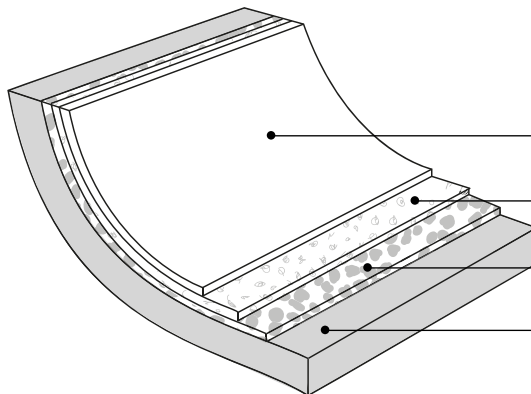

Capa superior de alto nivel anti-adherente
High-release topcoat

Capa media parcialmente reforzada
Lightly reinforced midcoat

Capa primera reforzada con partículas de titanio
Primer reinforced with titanium-based particles

Base de aluminio forjado
Metal substrate



EXCELLENT RELEASE



SUPERIOR DURABILITY



MADE WITHOUT PFOA



MADE WITHOUT PFOS



REGULATORY COMPLIANT



SCRATCH RESISTANT



DISHWASHER SAFE



HEALTHFUL COOKING



EASY CLEAN

[QuanTanium™] is a trademark of PPG Industries Ohio, Inc., used with permission. © 2020 PPG Industries, Inc. All rights reserved.

	Corbata	Sleeve	Fourreau Carton	Cartone Protettivo	Gravata Cartão
--	---------	--------	-----------------	--------------------	----------------



18 cm

714000



Sartén Antiaderente // Non-Stick Fry Pan // Poêle Anti-adhésive Padella Antiaderente // Frigideira Antiaderente



20 cm

714100



Sartén Antiaderente // Non-Stick Fry Pan // Poêle Anti-adhésive Padella Antiaderente // Frigideira Antiaderente



22 cm

714200



Sartén Antiaderente // Non-Stick Fry Pan // Poêle Anti-adhésive Padella Antiaderente // Frigideira Antiaderente



24 cm

714300



Sartén Antiaderente // Non-Stick Fry Pan // Poêle Anti-adhésive Padella Antiaderente // Frigideira Antiaderente

	Corbata	Sleeve	Fourreau Carton	Cartone Protettivo	Gravata Cartão
---	---------	--------	-----------------	--------------------	----------------



26 cm

714400



Sartén Antiadherente // Non-Stick Fry Pan // Poêle Anti-adhésive Padella Antiaderente // Frigideira Antiaderente



28 cm

714500



Sartén Antiadherente // Non-Stick Fry Pan // Poêle Anti-adhésive Padella Antiaderente // Frigideira Antiaderente



30 cm

714600



Sartén Antiadherente // Non-Stick Fry Pan // Poêle Anti-adhésive Padella Antiaderente // Frigideira Antiaderente



28 cm

715500



Wok Antiadherente // Non-Stick Wok // Wok Anti-adhésive Wok Antiaderente // Wok Antiaderente

	Corbata	Sleeve	Fourreau Carton	Cartone Protettivo	Gravata Cartão
--	---------	--------	-----------------	--------------------	----------------



16cm/1,4L

715200

 16cm/6,2"

Cazo // Sauce Pan // Casserole
Padella // Caçarola Com Rabo



20cm/3,1L

715300

 20cm/7,8"

Cazo // Sauce Pan // Casserole
Padella // Caçarola Com Rabo

	Caja	Box	Boîte	Scatola	Caixa
---	------	-----	-------	---------	-------



20cm/3,1L

714900

 20cm/7,8"

Cacerola // Casserole // Sauteuse
Casseruola // Caçarola Com Rabo



24cm/4,9L

715000

 24cm/9,4"

Cacerola // Casserole // Sauteuse
Casseruola // Caçarola Com Rabo



28cm/3,7L

715100

 28cm/11"

Cacerola // Casserole // Sauteuse
Casseruola // Caçarola Com Rabo

	Corbata	Sleeve	Fourreau Carton	Cartone Protettivo	Gravata Cartão
---	---------	--------	-----------------	--------------------	----------------



28x28 cm

715400



28x28cm/11x11"

Grill Antiaderente // Non-Stick Grill // Gril Anti-adhésif // Grill Antiaderente // Grelhador Antiaderente



20-24 cm

715800



20-24cm/7,8-9,4"

Set de sartenes // 2 Frying pan set // Set 2 poêle // Set 2 Padelle // Set 2 Frigideiras

	Caja	Box	Boîte	Scatola	Caixa
--	------	-----	-------	---------	-------



x5

697400

Batería de Cocina // Cookware Set Batterie de Cuisine // Batteria da Cucina // Conjunto de panelas

5 Piezas // 5 Pieces // 5 Pezzi 5 Pezzi // 5 peças



715200
16cm/-6,2"



714900
20cm/7,8-9,4"



715000
24cm/9,4"



715100
28cm/11"





715400
28x28cm//11x11"



PROFESSIONAL UTENSILS
USTENSILES PROFESSIONNELS
UTENSILI PROFESSIONALI
FERRAMENTAS PROFISSIONAIS

ÚTILES
PROFESIONALES



	Caja	Box	Boîte	Scatola	Caixa
	Acero Inoxidable NITRUM® Polipropileno	NITRUM® Stainless Steel Polypropylene	Acier Inoxydable NITRUM® Polypropylène	Acciaio Inossidabile NITRUM® Polipropilene	Aço Inoxidável NITRUM® Polipropileno



277100



Electricista // Electrician Knife
C. Électricien // Coltello Eletttricista
Elettricista



	Display	Display	Carte	Display	Display
	Acero Inoxidable Polipropileno	Stainless Steel Polypropylene	Acier Inoxydable Polypropylène	Acciaio Inossidabile Polipropilene	Aço Inoxidável Polipropileno



790200



Gubia // Gouge // Gouge
Sgorbia // Goiva

	Display	Display	Carte	Display	Display
	Acero Inoxidable Acero Inoxidable	Stainless Steel Stainless Steel	Acier Inoxydable Acier Inoxydable	Acciaio Inossidabile Acciaio Inossidabile	Aço Inoxidável Aço Inoxidável

795000



Lira de Queso // Cheese Lira
Lyre à Fromage // Taglia Formaggio
a Filo // Lira de Queijo

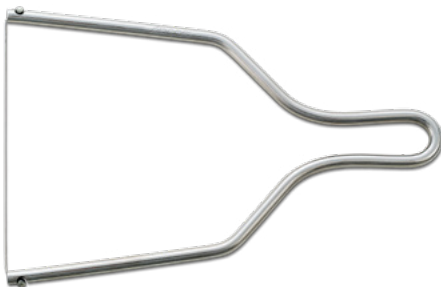



795100

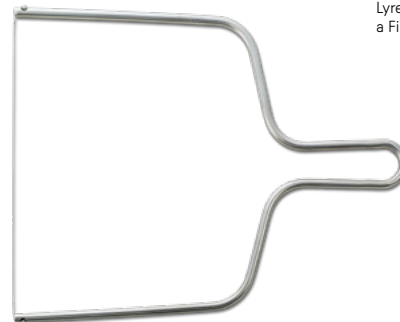

Lira de Queso // Cheese Lira
Lyre à Fromage // Taglia Formaggio
a Filo // Lira de Queijo



	Caja	Box	Boîte	Scatola	Caixa
	Acero Inoxidable Polietileno	Stainless Steel Polyethylene	Acier Inoxydable Polyéthylène	Acciaio Inossidabile Polietilene	Aço Inoxidável Polietileno



791600



Corta Bacalao-Pan // Codfish - Bread Cutting Knife // C. Coupe Pain // Taglia-Baccalà - Pane Corta-Bacalhau - Pão



689900



Tabla Panera // Bread Cutting Board // Planche Coupe Pain Tagliere Taglia Pane // Tábua de Cortar Pão

	Caja	Box	Boîte	Scatola	Caixa
	Acero Inoxidable Acero Inoxidable	Stainless Steel Stainless Steel	Acier Inoxydable Acier Inoxydable	Acciaio Inossidabile Acciaio Inossidabile	Aço Inoxidável Aço Inoxidável



790500

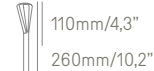

Escamador de pescado // Scaling Knife // Écailleur // Squama-Pesce Escalador Peixe

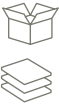
	Caja	Box	Boîte	Scatola	Caixa
	Acero Inoxidable Acero Inoxidable	Stainless Steel Stainless Steel	Acier Inoxydable Acier Inoxydable	Acciaio Inossidabile Acciaio Inossidabile	Aço Inoxidável Aço Inoxidável



790600

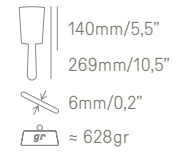

Aplastador de Filetes // Meat tenderizer // Batte à Cotelette Batticarne // Amaciador Carne

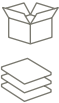
	Caja	Box	Boîte	Scatola	Caixa
	Acero Inoxidable Polioximetileno (POM)	Stainless Steel Polyoxymethylene (POM)	Acier Inoxydable Polyoxyméthylène (POM)	Acciaio Inossidabile Polioximetileno (POM)	Aço Inoxidável Polioximetileno (POM)

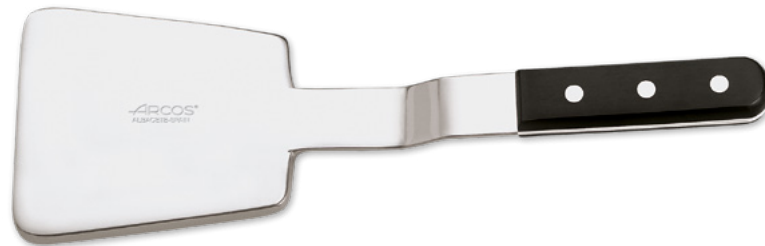

790800

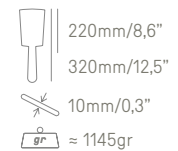

Aplastador de Filetes // Meat tenderizer // Batte à Cotelette Batticarne // Amaciador Carne

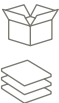
	Caja	Box	Boîte	Scatola	Caixa
	Acero Inoxidable Polipropileno	Stainless Steel Polypropylene	Acier Inoxydable Polypropylène	Acciaio Inossidabile Polipropilene	Aço Inoxidável Polipropileno



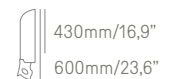

791800



Sierra Carnicero // Butcher Saw Scie Boucher // Segada Macellaio Serra Carniceiro



GADGETS



	Caja	Box	Boîte	Scatola	Display
	Acero Inoxidable Polipropileno	Stainless Steel Polypropylene	Acier Inoxydable Polypropylène	Acciaio Inossidabile Polipropilene	Aço Inoxidável Polipropileno



277200



Abre Ostras // Oyster Knife
C. Ouvre Huitres // Apri-Ostriche
Abre-Ostras



	Display	Display	Carte	Display	Display
	Acero Inoxidable Polipropileno	Stainless Steel Polypropylene	Acier Inoxydable Polypropylène	Acciaio Inossidabile Polipropilene	Aço Inoxidável Polipropileno



613600



Decorador Frutas
Fruit Decorator // Décorateur à
Fruits // Decoratore Frutta
Decorador Frutas

	Caja	Box	Boîte	Scatola	Caixa
	Acero Inoxidable ABS	Stainless Steel ABS	Acier Inoxydable ABS	Acciaio Inossidabile ABS	Aço Inoxidável ABS



780800



Mantequilla // Butter Knife
C. Beurre // Coltello burro //
Manteiga

	<p>Display</p> <p>Acero Inoxidable Polipropileno</p>	<p>Display</p> <p>Stainless Steel Polypropylene</p>	<p>Carte</p> <p>Acier Inoxydable Polypropylène</p>	<p>Display</p> <p>Acciaio Inossidabile Polipropilene</p>	<p>Display</p> <p>Aço Inoxidável Polipropileno</p>
--	--	---	--	--	--



613000

50mm/1,9"
156mm/6,1"
25mm /0,9"

Vaciador-Decorador // Melon Baller
Moule à Pomme // Scavino
Esvaziador-Decorado



613100

60mm/2,3"
165mm/6,4"
22-25mm /0,8-0,9"

Doble Vaciador // Double Melon
Baller // Moule à Pomme double
Scavino doppio // Duplo
Esvaziador-Decorado



616600

65mm/2,5"
170mm/6,6"

Mondador Naranjas // Canal Knife
Canneleur d'orange // Pela-arance
Descascador Laranjas



612700

40mm/1,5"
150mm/5,9"

Mondador Naranjas // Canal Knife
Canneleur d'orange // Pela-arance
Descascador Laranjas



612200

90mm/3,5"
192mm/7,5"

Decorador // Decorating Knife
Décorateur // Coltello Decoratore
Decorador



612300

75mm/2,9"
185mm/7,2"

Descorazonador // Apple Corer
Vide Pomme // Coltello Tagliamela
Descaroçado

	Display Acero Inoxidable Polipropileno	Display Stainless Steel Polypropylene	Carte Acier Inoxydable Polypropylène	Display Acciaio Inossidabile Polipropilene	Display Aço Inoxidável Polipropileno
---	--	---	--	--	--



616800

117mm/4,6"
225mm/8,8"

Descorazonador // Apple Corer
 Vide Pomme // Coltello Tagliamela
 Descarado



612800

40mm/1,5"
145mm/5,7"

Rallador Limones // Decorating
 Zester // Canneleur Zesteur
 Rigalimoni // Ralador Limõe



613200

85mm/3,3"
190mm/7,4"

Rizador Mantequilla // Butter
 Curler // Coquilleur à Beurre
 Arricia-burro // Modelador
 Manteiga



614200

90x20mm/3,5x0,7"
215mm/8,4"

Espátula // Spatula // Spatule
 Spatola // Espátula



614300

220x35mm/8,6x1,3"
352mm/13,8"

Espátula // Spatula // Spatule
 Spatola // Espátula



614400

280x35mm/11"x1,3"
402mm/15,8"

Espátula // Spatula // Spatule
 Spatola // Espátula

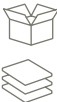
	Display Acero Inoxidable Polipropileno	Display Stainless Steel Polypropylene	Carte Acier Inoxydable Polypropylène	Display Acciaio Inossidabile Polipropilene	Display Aço Inoxidável Polipropileno
--	--	---	--	--	--



613700

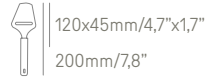

Corta Queso // Cheese plane
 Coupe Fromage // Taglia-formaggio
 Corta-Queijo



613800



Rallador Queso // Cheese Grater
 Rape à Fromage // Grattugia
 Ralador-Queijo



614500

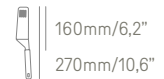

Espátula Servir // Serving Spatula
 // Spatule de Service // Spatola da
 Servire // Espátula de Servir



614600



Espátula Servir // Serving Spatula
 Spatule de Service // Spatola da
 Servire // Espátula de Servir



614800

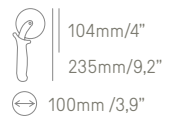

Corta Pizza // Pizza Cutter
 Coupe Pizza // Tagliapizza
 Corta Pizza

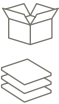
	Display	Display	Carte	Display	Display
	Acero Inoxidable	Stainless Steel	Acier Inoxydable	Acciaio Inossidabile	Aço Inoxidável



606200

300mm/11,8"



Pinza Emplatat // Plating Pincer
Pince à Servir // Pinza Servire
Pinças Servir



606300

200mm/7,8"



Pinza Emplatat // Plating Pincer
Pince à Servir // Pinza Servire
Pinças Servir



606500

140mm/5,5"

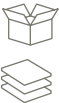

Pinza Emplatat // Plating Pincer
Pince à Servir // Pinza Servire
Pinças Servir

	Display	Display	Carte	Display	Display
	Acero Inoxidable 18/10	Stainless Steel 18/10	Acier Inoxydable 18/10	Acciaio Inossidabile 18/10	Aço Inoxidável 18/10



606100

120mm/4,7"



Pinza Jamón // Ham Pincer
Pince à Jambon // Pinza Prosciutto
Pinça Presunto





605100

100mm/3,9"



Pinza Jamón // Ham Pincer
Pince à Jambon // Pinza Prosciutto
Pinça Presunto

	Display	Display	Carte	Display	Display
	Acero Inoxidable	Stainless Steel	Acier Inoxydable	Acciaio Inossidabile	Aço Inoxidável



605000

110mm/4,3"



Pinza Pescado // Fish Pincer
 Pince à Arêtes // Pinza Pesce
 Pinça Peixe



606400

185mm/7,2"



Tenaza Marisco // Lobster Cracker
 Pince Crustacés // Pinza Crostacei
 Pinça Marisco

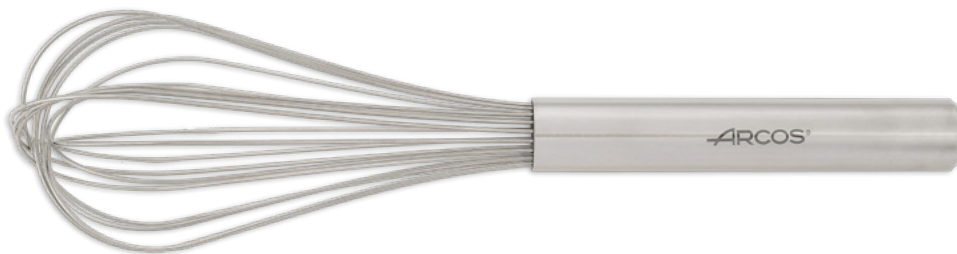

613300

250mm/9,8"



Batidora Varilla // Whisk
 Fouet // Frusta // Batedor de
 Varetas

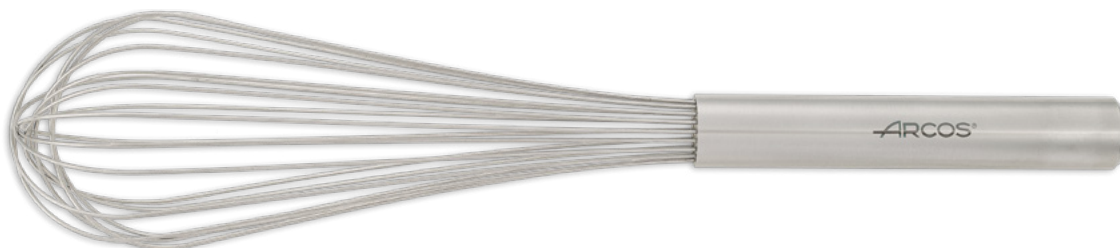

613400

300mm/11,8"

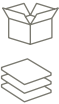

Batidora Varilla // Whisk
 Fouet // Frusta // Batedor de
 Varetas

	Display	Display	Carte	Display	Display
	Acero Inoxidable	Stainless Steel	Acier Inoxydable	Acciaio Inossidabile	Aço Inoxidável



607000



Utensilio Pelador // Peeler
Éplucheur // Pelapatate
Descascador



607100





Utensilio Pelador Tomate // Tomato
Peeler // Éplucheur Tomate
Pelapomodoro // Descascador
Tomate



607200



Cortador de Juliana // Julienne
Cutter // Éplucheur Julienne
Tagliatore Julienne // Descascador
Juliana

	Caja	Box	Boîte	Scatola	Caixa
	Acero Inoxidable Polipropileno (PP)	Stainless Steel Polypropylene (PP)	Acier Inoxydable Polypropylène (PP)	Acciaio Inossidabile Polipropilene (PP)	Aço Inoxidável Polipropileno (PP)



NEW

607300

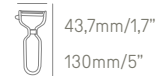

Utensilio Pelador // Peeler
Éplucheur // Pelapatate
Descascador



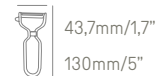

NEW

607420



Utensilio Pelador Tomate // Tomato
Peeler // Éplucheur Tomate
Pelapomodoro // Descascador
Tomate



	Caja Expositora	Display Box	Boîte Présentoir	Scatola Expo	Caixa Expositora
	Acero Inoxidable NITRUM® Polipropileno (PP)	NITRUM® Stainless Steel Polypropylene (PP)	Acier Inoxydable NITRUM® Polypropylène (PP)	Acciaio Inossidabile NITRUM® Polipropilene (PP)	Aço Inoxidável NITRUM® Polipropileno (PP)



181300



Mondador // Potato Peeler
C. Eplucheur // Speluchino
Descascador

	Display	Display	Carte	Display	Display
	Acero Inoxidable Polipropileno (PP)	Stainless Steel Polypropylene (PP)	Acier Inoxydable Polypropylène (PP)	Acciaio Inossidabile Polipropilene (PP)	Aço Inoxidável Polipropileno (PP)



612100



Mondador // Potato Peeler
Éplucheur // Pelapatate
Descascador

	Display	Display	Carte	Display	Display
	Polipropileno (PP)	Polypropylene (PP)	Polypropylène (PP)	Polipropilene (PP)	Polipropileno (PP)



617100

200mm/7,8"



Brocha Pastelero // Pastry Brush
Pinceau à Pâtisserie // Pennello
Dolci // Brocha Pasteleiro

	Display	Display	Carte	Display	Display
	Silicona Metal	Silicone Metal	Silicone Métal	Silicone Metallo	Silicone Metal



617200

286mm/11,2"



Lengua Silicona Negro // Silicone
Spatula Black // Maryse Silicone
Noir // Leccapentola Nero
Espátula Silicone Preto

UTENSILS
USTENSILES
UTENSILI
FERRAMENTAS



UTENSILIOS

	Display Acero Inoxidable Silicona	Display Stainless Steel Silicone	Carte Acier Inoxydable Silicone	Display Acciaio Inossidabile Silicone	Display Aço Inoxidável Silicone
---	---	--	---------------------------------------	---	---------------------------------------



NEW

685000

331mm/13"



Espátula // Espátula // Spatula
 Spatule // Spatola // Espátula



NEW

685200

337mm/13,2"



Cuchara Pasta // Pasta Server
 Cuillère Spaghetti // Cucchio di
 Pasta // Colher Para Massa



NEW

685300

339mm/13,3"



Espátula Ranurada // Slotted
 Turner // Spatule Ajourée
 Spatola Scanalata // Espátula con
 Fessure



NEW

685500

350mm/13,7"



Espumadera // Skimmer
 Écumoire // Schiumarola
 Espumadeira



NEW

685100

330mm/12,9"



Cuchara // Spoon // Cuillère
 Cucchio // Colher



NEW

685400

323mm/12,7"



Cazo // Ladle // Louche // Mestolo
 Concha

	Caja Regalo	Gift Box	Boîte Cadeau	Scatola Regalo	Caixa de Oferta
	Aleación de Zinc	Zinc Alloy	Alliage de Zinc	Lega di Zinco	Liga de Zinco



603000

160mm/6,2"



Cascañueces // Cascanueces
Nut & Sea Food Cracker // Casse
Noix // Schiaccianoci // Quebra-
Nozes



603500

190mm/7,4"



Prensa Ajos // Garlic Press
Presse Ail // Spremiaglio
Espremedor de Alhos



603600

190mm/7,4"



Abrelatas // Can Opener
Ouvre Boîte // Aprilatine //
Abridor de latas



604500

Juego 5 Pzas. // 5 Pc. Set
Jeu 5 Pièces // Set 5 Pezzi
Jogo Gadgets

	Display Acero Inoxidable 304 Silicona	Display Stainless Steel 304 Silicone	Carte Acier Inoxydable 304 Silicone	Display Acciaio Inossidabile 304 Silicone	Display Aço Inoxidável 304 Silicone
---	---	--	---	---	---



NEW

685600

300mm/11,8"



Pinzas de Cocina // Kitchen Tongs
Pinze da Cucina // Pince de Cuisine
Pinças de Cozinha

	Caja Acero Inoxidable ABS	Box Stainless Steel ABS	Boîte Acier Inoxydable ABS	Scatola Acciaio Inossidabile ABS	Caixa Aço Inoxidável ABS
--	---------------------------------	-------------------------------	----------------------------------	--	--------------------------------



793100

| 280mm/11"

↔ 150mm /5,9"

Portarrollos Cocina // Paper Towel Holder // Porte Rouleau Papier
Portarrotoli // Porta-Rolos

ACCESSORIES
COMPLÉMENTS
COMPLEMENTI
COMPLEMENTOS



COMPLEMENTOS



AFILADORES

Sharpeners // Aiguiseurs
Affilatori // Afiadores

PÁG 280-282



CHAIRAS

Sharpening Steels // Fusils
Acciaini Affilatori // Fuzís

PÁG 283-286



GUANTES DE PROTECCIÓN

Safety Gloves // Gants de Protection // Guanti Antitaglio
Luva de Proteção

PÁG 287-288



TABLAS

Cutting Boards // Planches à Découper // Taglieri // Tábuas de Cortar

PÁG 289-291



SOPORTES

Knife Holder // Blocs
Couteaux // Porta Coltelli
Suporte Facas

PÁG 295-299



SOPORTES MÁGNÉTICOS

Magnetic racks // Barres
Aimantées // Suportes
Magnéticos

PÁG 300-301



BOLSAS PARA CUCHILLOS

Knives Roll Bag // Trousses
Couteaux // Borsa Portacoltelli
Saco para Facas

PÁG 292-294



SACACORCHOS

Corkscrew // Tire-Bouchon
Cavatappi // Saca-Rolhas

PÁG 302-304



SOPORTES PARA JAMÓN

Ham Holder // Supports Jambon
Supporto Prosciutto // Suporte
Para Presunto

PÁG 305-306



AFILADORES

SHARPENERS
AIGUISEURS
AFFILATORI
AFIADORES

Los afiladores son esenciales para la seguridad en la cocina; mantienen los cuchillos en afilados, asegurando cortes limpios y minimizando el esfuerzo y el riesgo de accidentes.

Sharpeners are essential for kitchen safety; they keep knives sharp, ensuring clean cuts and minimizing effort and the risk of accidents.

Les aiguiseurs sont essentiels pour la sécurité en cuisine ; ils maintiennent les couteaux aiguisés, assurant des coupes nettes et minimisant l'effort et le risque d'accidents.

Gli affilatori sono essenziali per la sicurezza in cucina; mantengono i coltelli affilati, garantendo tagli puliti e minimizzando lo sforzo e il rischio di incidenti.

Afiadores são essenciais para a segurança na cozinha; mantêm as facas afiadas, garantindo cortes limpos e minimizando o esforço e o risco de acidentes.

Afilado Perfecto

Perfect Sharpening · Affûtage Parfait · Affilatura Perfetta · Afição perfeita.

Precisión de Uso



Precision of Use · Précision d'Utilisation · Precisione d'Uso · Precisão de Uso.

Uso Rápido e Intuitivo

Quick and intuitive Use · Utilisation Rapide et Intuitive
Uso Rapido e Intuitivo · Uso Rápido e Intuitivo.

Mantenimiento Simple

Simple Maintenance · Entretien Facile · Manutenzione
Semplice · Manutenção Simples.

	Caja	Box	Boîte	Scatola	Caixa
	ABS	ABS	ABS	ABS	ABS



610000

Afilador Profesional ABS
 Professional Sharpener ABS
 Aiguiseur Professionnel ABS
 Affilatore Prof. ABS
 Afiador Profissional ABS

	Blister	Blister	Blister	Blister	Blister
	Plástico	Plastic	Plastique	Plastico	Plástico



610200

Afilador Prof. Bolsillo
 Professional Pocket Sharpener
 Aiguiseur Professionnel Poche
 Affilatore Prof. Tasca
 Afiador Profissional Bolso

	Caja	Box	Boîte	Scatola	Caixa
	ABS + TPE Rodillos Cerámico y Carburo	ABS + TPE Carbide and Ceramic Rollers	ABS + TPE Rouleaux Céramique et Carbone	ABS + TPE Rulli in Ceramica e Carburo	ABS + TPE Rolos de cerâmica e de carboneto



610600

Afilador ABS // Sharpener ABS
 Aiguiseur ABS // Affilatore ABS
 Afiador de Mão ABS

	Caja	Box	Boîte	Scatola	Caixa
	ABS Rodillos Recubiertos Diamante	ABS Diamond-Coated Rolls	ABS Rouleaux Revêtement Diamant	ABS Rulli Rivestiti di Diamante	ABS Rôlos Revestidos com Diamante



603900

Afilador Eléctrico // Electric Knife Sharpener // Aiguseur Electrique Affilatore Elettrico // Afiador Elétrico

	Caja	Box	Boîte	Scatola	Caixa
	ABS + TPE Rodillos Recubiertos Diamante	ABS + TPE Diamond-Coated Rolls	ABS + TPE Rouleaux Revêtement Diamant	ABS + TPE Rulli Rivestiti di Diamante	ABS + TPE Rôlos Revestidos com Diamante



610700

Afilador Profesional Eléctrico Professional Electric Knife Sharpener Aiguseur Professionel Electrique Affilatore Prof.Elettrico Afiador Profissional Elétrico



CHAIRAS

SHARPENING STEELS

FUSILS

ACCIAINI

FUZIS

Los cuchillos sufren un fuerte desgaste debido al uso cotidiano. La utilización de la chaira garantiza el mantenimiento del filo y alarga su vida útil.

Knives undergo heavy wear from daily use. Using a sharpening steel ensures the maintenance of the edge and prolongs its useful life.

Les couteaux subissent une forte usure due à leur utilisation quotidienne. L'utilisation d'un fusil à aiguiser garantit le maintien du tranchant et prolonge leur durée de vie.

I coltelli subiscono un forte usura a causa dell'uso quotidiano. L'utilizzo di una chaira garantisce il mantenimento del filo e ne allunga la vita utile.

As facas sofrem um forte desgaste devido ao uso diário. O uso de uma chaira garante a manutenção do fio e prolonga sua vida útil.

Materiales Resistentes

Resistant materials · Matériaux résistants · Materiali Resistenti
Materiais Resistentes.

Superficie Texturizada

Textured surface · Surface Texturée · Superficie Testurizzata
Superficie Texturizada.

Uso Seguro

Safe Use · Utilisation Sûre · Uso Sicuro · Uso Seguro.

10 Años de Garantía

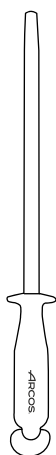

10-Year Warranty · Garantie 10 Ans · Garanzia 10 Anni · Garantia
de 10 Anos.



 	Caja - 279200, 279400 Estuche - 279202	Box - 279200, 279400 Case - 279202	Boîte - 279200, 279400 Étui - 279202	Scatola - 279200, 279400 Astuccio - 279202	Caixa - 279200, 279400 Estojo - 279202
	Acero al Carbono Recubierto de Diamante Polipropileno	Carbon Steel Coated Diamond-coated Polypropylene	Acier au Carbone Revêtement diamant Polypropylène	Acciaio al Carbonio Rivestito di diamante Polipropilene	Aço Carbono Revestido de diamante Polipropileno



279200/ 279202

 280mm/11"
 431mm/16,9"
 17mm /0,6"

Chaira Diamante Ovalada
Diamond Sharpening Steel // Fusil
Diamant Mèche Ovale // Acciaino
al Diamante // Afiador de Aço
(Oval, Revestida de Diamante)



279400



 240mm/9,4"
 365mm/14,3"
 10mm/0,3"

Chaira Diamante
Diamond Sharpening Steel
Fusil Diamant Mèche // Acciaino
al Diamante Afiador de Aço
(Revestida de Diamante)

 	Caja - 278100, 278400, 278200 Estuche - 278138	Box- 278100, 278400, 278200 Case - 278138	Boîte -278100, 278400, 278200 Étui - 278138	Scatola -278100, 278400, 278200 Astuccio - 278138	Caixa - 278100, 278400, 278200 Estojo - 278138
	Acero al Carbono Recubierto de Diamante Polipropileno	Carbon Steel Coated Diamond-coated Polypropylene	Acier au Carbone Revêtement diamant Polypropylène	Acciaio al Carbonio Rivestito di diamante Polipropilene	Aço Carbono Revestido de diamante Polipropileno





278100/278138

 230mm/9,0"
 375mm/14,7"
 10mm/0,3"

Chaira // Sharpening Steel
Fusil Mèche Ronde // Acciaino
Afiador de Aço Preto





278400

 250mm/9,8"
 385mm/15,1"
 10mm /0,3"



Chaira // Sharpening Steel
Fusil Mèche Ronde // Acciaino
Afiador de Aço Preto



278200

 250mm/9,8"
 375mm/14,7"
 13mm/0,5"

Chaira // Sharpening Steel
Fusil Mèche Ronde // Acciaino
Afiador de Aço Preto

	Caja	Box	Boîte	Scatola	Caixa
	Acero al Carbono Cromado Polipropileno	Carbon Steel Chromium Coated Polypropylene	Acier au Carbone Chromé Polypropylène	Acciaio al Carbonio Cromato Polipropilene	Aço carbono cromado Polipropileno



782100

230mm/9"
335mm/13,8"
10mm /0,3"

Chaira // Sharpening Steel
Fusil Mèche Ronde // Acciaino
Afiador de Aço Preto



278510

300mm/11,8"
440mm/17,3"
13mm/0,5"

**Chaira de Grano Fino // Fine Grain
Honing Steel // Fusil Taillage Fin
Mèche Ronde // Affilatoio a Grana
Fine // Afiador de Grão Fino**

● 278511 ● 278512 ● 278513 ○ 278514 ● 278515



279010

300mm/11,8"
440mm/17,3"
17mm /0,6"

Chaira de Grano Fino Ovalada
Fine Grain Oval Honing Steel
Fusil Taillage Fin Mèche Ovale
Affilatoio Ovale a Grana Fine
Afiador de Grão Fino Oval



NEW

279600

300mm/11,8"
440mm/17,3"
20mm /0,7"

**Chaira de Grano Extra Fino
Ovalada // Extra Fine Grain Oval
Honing Steel // Fusil Taillage Extra
-Fin Mèche Ovale // Affilatoio ovale
a Grana Super Fine // Afiador de
Grão Extra Fino Oval**

● 279623



NEW

279900

350mm/13,7"
490mm/19,3"
20mm /0,7"

**Chaira de Grano Extra Fino
Ovalada // Extra Fine Grain Oval
Honing Steel // Fusil Taillage Extra
-Fin Mèche Ovale // Affilatoio ovale
a Grana Super Fine // Afiador de
Grão Extra Fino Oval**

● 279923

Afilar

AFILAR UN CUCHILLO

SHARPENING A KNIFE

AIGUISER UN COUTEAU

COME AFFILARE UN COLTELLO

AFIAR UMA FACA

Si mantiene el filo del cuchillo afilado ayudará a que cumpla su función adecuadamente y alargará la vida de su producto. Lo más aconsejable es el uso periódico de chairas o aceros para el mantenimiento de los filos de sus cuchillos:

Coloque la hoja del cuchillo y la chaira formando un ángulo agudo (20°).

El brazo que sujeta la chaira no debe moverse, y la otra mano apoyará ligeramente la hoja sobre la chaira y la deslizará sobre ésta manteniendo el ángulo.

Pase repetidamente la hoja del cuchillo sobre la chaira.

Afile el otro lado de la hoja repitiendo los mismos movimientos, esta vez por el otro lado de la chaira.

Lo ideal es alternar las pasadas del filo por la chaira, para conseguir una perfecta simetría en un lado sin cargar el otro.

Keeping the blade's cutting edge sharpened will help the knife to work properly and safely and it will last much longer.

Hold the blade at a 20° angle against the honing steel.

Keep the arm that is holding the steel steady and swipe the blade lightly over the steel keeping the angle at 20°.

Sharpen the other side of the blade as before, this time using the other side of the honing steel.

Give each side of the knife an equal number of swipes (about 20).

The ideal is to swipe both sides of the blade alternately to get a perfectly even sharpness on both sides of the blade.

Entretien le fil du couteau permettra à celui-ci de répondre à sa fonction première qui est de couper et allongera sa durée de vie.

Le meilleur conseil est d'utiliser régulièrement un fusil pour maintenir le fil de son couteau:

En positionnant la lame à un angle de 20° par rapport à la mèche, la main qui tient le fusil ne doit pas bouger et l'autre main, appuyant légèrement la lame sur la mèche du fusil, laisse glisser celle-ci en maintenant cet angle.

Passer plusieurs fois la lame du couteau sur le fusil.

Aiguiser l'autre côté de la lame en répétant le même mouvement, mais cette fois-ci de l'autre côté de la mèche du fusil.

L'idéal est d'alterner les passages du fil sur la mèche du fusil, pour obtenir une parfaite symétrie de l'aiguisage de part et d'autre de la lame.

Mantenere il filo ad un coltello contribuisce al buon funzionamento del prodotto ed alla sua durata nel tempo.

Consigli per un utilizzo ottimale per una buona affilatura con acciaino: Posizionate la lama del coltello e l'acciaino in modo da formare un angolo acuto a 20°.

Il braccio e la mano che sostiene l'acciaino non deve muoversi, mentre l'altra mano appoggerà leggermente la lama sull'acciaino e la farà scivolare mantenendo l'angolo come sopra indicato.

Ripetere l'operazione di passaggio della lama sull'acciaino più volte.

Affilate l'altro lato della lama ripetendo i medesimi movimenti.

L'affilatura ideale si ottiene ripassando più volte alternativamente i due lati della lama sull'acciaino.

Manter o gume da sua faca afiado ajuda a desempenhar corretamente a sua função e prolonga a vida útil do seu produto. O mais aconselhável é utilizar periodicamente o fuzil para manter o fio das suas facas: Colocar a lâmina da faca e o fuzil num ângulo agudo (20°). O braço que segura o fuzil não deve mover-se e a outra mão deve apoiar ligeiramente a lâmina no fuzil e deslizará-la sobre o aço de afiar, mantendo o ângulo. Passar repetidamente a lâmina da faca sobre o fuzil. Afie o outro lado da lâmina repetindo os mesmos movimentos, desta vez no outro lado do fuzil. O ideal é alternar as passagens da lâmina sobre o fuzil para obter uma simetria perfeita em ambos os lados.

has context menu

20°





GUANTES DE PROTECCIÓN

SAFETY GLOVES
GANTS PROTECTION
GUANTI ANTITAGLIO
LUA DE POTEÇÃO

El uso de guantes protectores es fundamental al manejar herramientas cortantes, previniendo cortes y lesiones en manos y antebrazos. Proporcionan protección variada y se adaptan a cada necesidad.

The use of protective gloves is fundamental when handling sharp tools, preventing cuts and injuries to hands and forearms. They provide varied protection and adapt to every need.

L'utilisation de gants de protection est fondamentale lors de la manipulation d'outils tranchants, prévenant les coupures et les blessures aux mains et avant-bras. Ils offrent une protection variée et s'adaptent à chaque besoin.

L'uso di guanti protettivi è essenziale nella manipolazione di strumenti affilati per prevenire tagli e lesioni alle mani. Offrono protezione variabile e si adattano ad ogni esigenza.

O uso de luvas protetoras é fundamental ao manusear ferramentas cortantes, prevenindo cortes e lesões em mãos e antebraços. Proporcionam proteção variada e se adaptam a cada necessidade.

Uso Ambidiestro

Ambidextrous Use • Utilisation Ambidextre • Uso Ambidestro • Uso Ambidestro.

Multiples Tallas Disponibles



Multiple Sizes available • Plusieurs Tailles Disponibles • Diverse Taglie Disponibili • Vários Tamanhos Disponíveis.

Protege de Lesiones

Protects from Injuries • Protège des Blessures • Protegge dalle Lesioni • Protege de Lesões.

Refuerzos Flexibles en los Puños

Flexible Reinforcements on the Cuffs • Renforts Flexibles aux poignets • Rinforzi Flessibili Sui Polsini • Reforços Flexíveis nos Punhos.

	Caja	Box	Boîte	Scatola	Caixa
	Acero Inoxidable	Stainless Steel	Acier Inoxydable	Acciaio Inossidabile	Aço Inoxidável



615000

 0-XXS 188mm/7,4"

Guante Malla // Chainmail Glove
Gant en Maille // Guanto In Maglia
Luva de Proteção



615100

 1-XS 200mm/7,8"

Guante Malla // Chainmail Glove
Gant en Maille // Guanto In Maglia
Luva de Proteção



615200

 2-S 212mm/8,3"

Guante Malla // Chainmail Glove
Gant en Maille // Guanto In Maglia
Luva de Proteção



615300

 3-M 225mm/8,8"

Guante Malla // Chainmail Glove
Gant en Maille // Guanto In Maglia
Luva de Proteção



615400

 4-L 237mm/9,3"

Guante Malla // Chainmail Glove
Gant en Maille // Guanto In Maglia
Luva de Proteção



TABLAS

Diseñadas para la rutina culinaria, nuestras tablas ofrecen manejo cómodo, almacenaje sencillo con orificio incorporado. Superficie para cortar sin dañar el filo del cuchillo. Resistente para cortes precisos y elegante presentación de alimentos.

Designed for the culinary routine, our boards offer comfortable handling, simple storage with an incorporated hole. A surface for cutting without damaging the knife's edge. Durable for precise cuts and elegant food presentation.

Conçues pour une utilisation quotidienne en cuisine, nos planches offrent une prise en main confortable, un rangement pratique grâce à leur ouverture intégrée. Une surface de découpe préservant le tranchant du couteau. Robustes pour des coupes précises et une présentation élégante des aliments.

Progettate per la routine culinaria, le nostre tavole offrono una maneggevolezza confortevole, un'immagazzinamento semplice con un foro incorporato. Una superficie per tagliare senza danneggiare il filo del coltello. Resistente per tagli precisi ed elegante presentazione dei cibi.

Desenhadas para a rotina culinária, nossas tábuas oferecem manuseio confortável, armazenamento simples com um orifício incorporado. Superfície para cortar sem danificar o fio da faca. Resistente para cortes precisos e elegante apresentação de alimentos.

Superficie protectora del Filo

Edge-Protecting Surface · Surface Protectrice du Fil · Superficie Protettiva del Filo · Superfície Protetora do Fio.

Orificio para Almacenamiento

Storage Hole · Trou Pour Rangement · Foro per l'immagazzinamento · Orifício para Armazenamento.

Limpieza Rápida y Sencilla

Quick and Easy Cleaning · Nettoyage Rapide et Simple · Pulizia Rapida e Semplice · Limpeza Rápida e Simples.



Variedad de Colores

Variety of Colors · Variété de Couleurs · Varie colorazioni · Variedade de Cores.

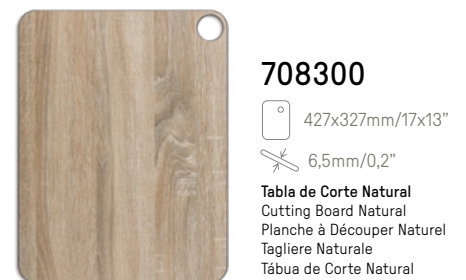
	Caja Fibra de Celulosa y Resina	Box Resin and Cellulose Fibre	Boîte Fibre de Cellulose et Résine	Scatola Fibra di Cellulosa e Resina	Caixa Fibra de Celulose e Resina
--	------------------------------------	----------------------------------	---------------------------------------	--	-------------------------------------



Resistencia al lavavajillas / Dishwasher safe / Compatible lave-vaisselle / Adatto per lavastoviglie / Resistente à máquina de lavar loiça
 No daña los cuchillos / Knife friendly / N'émousse pas le fil des couteaux / Non danneggia il filo dei coltelli / Não danifica as facas
 Resistencia a altas temperaturas / Heat resistant / Résistante aux hautes températures / Resistente alle alte temperature / Resistência a altas temperaturas
 Material Ecológico / ECO select / Matériau écologique / Materiale Ecologico / Material ecológico.

	Caja	Box	Boîte	Scatola	Caixa
	Fibra de Celulosa y Resina	Resin and Cellulose Fibre	Fibre de Cellulose et Résine	Fibra di Cellulosa e Resina	Fibra de Celulose e Resina



766100

 330x230mm/13x9"

 6,5mm/0,2"

Tabla Salsera Mármol
 Serving Board Marble
 Planche à Découper Marbre
 Servire Marmol
 Tábua de Corte Mármore



762110

 330x230mm/13x9"

 6,5mm/0,2"

Tabla de corte Negra
 Cutting Board Black
 Planche à Découper Noire
 Tagliere Nero
 Tábua de Corte Preta



709100

 330x230mm/13x9"

 6,5mm/0,2"

Tabla de corte Natural
 Cutting Board Natural
 Planche à Découper Naturel
 Tagliere Naturale
 Tábua de Corte Natural



766200

 377x227mm/15x9"

 6,5mm/0,2"

Tabla Salsera Mármol
 Serving Board Marble
 Planche à Découper Marbre
 Servire Marmol
 Tábua de Corte Mármore



692210

 377x227mm/15x9"

 6,5mm/0,2"

Tabla Salsera Negra
 Serving Board Black
 Planche à Découper Noire
 Tagliere Servire Nero
 Tábua de Corte Preta



709200

 377x227mm/15x9"

 6,5mm/0,2"

Tabla Salsera Natural
 Serving Board Natural
 Planche à Découper Naturel
 Tagliere Servire Naturale
 Tábua de Corte Natural



766300

 427x327mm/17x13"

 6,5mm/0,2"

Tabla Salsera Mármol
 Serving Board Marble
 Planche à Découper Marbre
 Tagliere Servire Marmol
 Tábua de Corte Mármore



692310

 427x327mm/17x13"

 6,5mm/0,2"

Tabla Salsera Negra
 Serving Board Black
 Planche à Découper Noire
 Tagliere Servire Nero
 Tábua de Corte Preta



709300

 427x327mm/17x13"

 6,5mm/0,2"

Tabla Salsera Natural
 Serving Board Natural
 Planche à Découper Naturel
 Tagliere Servire Naturale
 Tábua de Corte Natural



693810

 323x120mm/12,7x4,7"

 3mm/0,1"

Tabla Servir Negra
 Serving Board Black
 Planche Café Gourmand Noire
 Tagliere Servire Nero
 Tábua de Tapas Preta



709600

 330x230mm/13x9"

 6,5mm/0,2"

Tabla Salsera Natural
 Serving Board Natural
 Planche à Découper Naturel
 Tagliere Servire Naturale
 Tábua de Corte Natural





BOLSAS

KNIVES ROLL BAG

TROUSSE COUTEAUX

BORSA PORTACOLTELLI

BOLSAS PARA FACAS

Para desplazamientos culinarios, las bolsas para cuchillos son el compañero de viaje ideal, ofreciendo comodidad y organización para llevar cuchillos y utensilios esenciales de cocina.

For culinary travels, knife bags are the ideal travel companion, offering comfort and organization to carry knives and essential kitchen utensils.

Pour vos déplacements les déplacements culinaires, les sacs à couteaux sont le compagnon de voyage idéal, offrant confort et organisation pour transporter couteaux et ustensiles de cuisine préférés.

Per i viaggi culinari, le borse per coltelli sono il compagno di viaggio ideale, offrendo comfort e organizzazione per trasportare coltelli e utensili da cucina essenziali.

Para deslocamentos culinários, as bolsas para facas são a companhia de viagem ideal, oferecendo conforto e organização para levar facas e utensílios de cozinha essenciais.

Organización Sencilla



Simple Organization • Organisation Facile • Organizzazione Semplice
Organização Simples.

Diversas Capacidades de Almacenamiento

Various Storage Capacities • Diverses Capacités de Stockage • Diverse
Capacità di Stoccaggio • Diversas Sapacidades de Armazenamento.

Protección en Transporte

Protection in Transport • Protection lors du Transport
Protezione nel Trasporto • Proteção no Transporte.

	Caja	Box	Boîte	Scatola	Caixa
	100% Poliéster	100% Polyester	100% Polyester	100% Poliestere	100% Poliéster



690200

 460x275mm/18x11"

Bolsa Cuchillos // Knife Roll Bag
Trousse Couteaux // Borsa
Portacoltelli // Saco Facas

4 Piezas // 4 Pieces // 4 Places
4 Pezzi // 4 peças



690400

 500x510mm/19,6x20"

Bolsa Cuchillos // Knife Roll Bag
Trousse Couteaux // Borsa
Portacoltelli // Saco Facas

8 Piezas // 8 Pieces // 8 Places
8 Pezzi // 8 peças



690500

 730x510mm/28,7x20"

Bolsa Cuchillos // Knife Roll Bag
Trousse Couteaux // Borsa
Portacoltelli // Saco Facas

12 Piezas // 12 Pieces // 12 Places
12 Pezzi // 12 peças



691400

 520x920mm/20,4x36"

Bolsa Cuchillos // Knife Roll Bag
Trousse Couteaux // Borsa
Portacoltelli // Saco Facas

17 Piezas // 17 Pieces // 17 Places
17 Pezzi // 17 peças

	Bolsa Poliéster 600D con Recubrimiento PVC	Bag Polyester 600D Covering with PVC	Sac Polyester 600D avec Recouvrement PVC	Borsa Poliestere 600D Ricoperto in PVC	Saco Poliéster 600D Revestido de PVC
---	--	--	--	--	--

No incluye cuchillos // Knives not included
Couteaux non fournis // Coltelli non compresi
Não inclui facas.



694900

 330x480x185mm
12,9"x18,8"x7,2"

 ≈ 29L - 1,3Kg

Mochila Porta Cuchillos // Knife Backpack // Sac à dos Porte-couteaux // Zainetto Porta Coltelli Saco Facas

**9 Piezas // 9 Pieces // 9 Places
9 Pezzi // 9peças**

	Caja Bolsa de Piel y Herrajes Metálicos	Box Leather Bag with Metallic Ironworks	Boîte Sac en Cuir et Ferronneries Métalliques	Scatola Borsa in Pelle e Accessori Metallo	Caixa Bolsa de Couro e Ferragens Metálicas
---	---	---	---	--	--



694800

 863 x 446mm/34 x 17,5"

Bolsa Piel Cuchillos // Leather Knife Roll Bag // Trousse couteaux cuir // Borsa in pelle // Estojo de pele

**10 Piezas // 10 Pieces // 10 Places
10 Pezzi // 10 peças**



695100

 470 x 446mm
8,5 x 17,5"

Bolsa Piel Cuchillos // Leather Knife Roll Bag // Trousse couteaux cuir // Borsa in pelle // Estojo de pele

**5 Piezas // 5 Pieces // 5 Places
5 Pezzi // 5 peças**



SOportes PARA CUCHILLOS

KNIFE HOLDER
BLOCS COUTEAUX
PORTA COLTELLI
SUPORTE FACAS

Tacos que preservan el filo de los cuchillos y realzan la cocina con su diseño innovador, garantizando accesibilidad y estilo en cada uso.

Knife blocks that preserve the edge of the knives and enhance the kitchen with their innovative design, ensuring accessibility and style with every use.

Blocs de couteaux qui préservent le tranchant des couteaux et rehaussent la cuisine avec leur design innovant, garantissant accessibilité et style à chaque utilisation.

Blocchi per coltelli che preservano la lama dei coltelli e valorizzano la cucina con il loro design innovativo, garantendo accessibilità e stile in ogni utilizzo.

Blocos que preservam o fio das facas e realçam a cozinha com seu design inovador, garantindo acessibilidade e estilo a cada uso.

Protege el Filo de los Cuchillos

Protects the Knife Edge · Protège le Fil des Couteaux · Protegge il Filo dei Coltelli · Protege o Fio das Facas.

Variedad de Diseños

Various Designs · Designs Variés · Disegni Vari · Design Variados.

Funcionalidad

Functionality · Fonctionnel · Funzionalità · Funcionalidade.

Completa tu Cocina

Complete Your Kitchen · Complétez Votre Cuisine · Completa la Tua Cucina · Complete sua Cozinha.



	Caja Regalo	Gift Box	Boîte Cadeau	Scatola Regalo	Caixa de Presente
	Bambú	Bamboo	Bambou	Bambú	Bambu

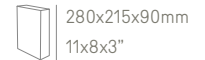

793800



Soporte Cuchillos // Knife Holder
 Bloc Couteaux // Porta Coltelli
 Suporte Facas

	Caja Regalo	Gift Box	Boîte Cadeau	Scatola Regalo	Caixa de Presente
	Caucho Termoplástico + Fibras de Polipropileno (PP)	Thermoplastic Rubber + Polipropylene (PP) Fibre	Caoutchouc Thermoplastique + Fibre Polypropylène (PP)	Caucciù Termoplastico + Fibre di Polipropilene (PP)	Borracha Termoplástica + Fibra Polipropileno (PP)



794400



Soporte Cuchillos Redondo
 Round Knife Holder // Bloc couteaux
 Rond // Porta Coltelli Rotondo
 Suporte Facas Redondo



794000



Soporte Cuchillos Redondo
 Round Knife Holder // Bloc Couteaux
 Rond // Porta Coltelli Rotondo
 Cepo Universal Redondo // Suporte
 Facas

 	Caja Regalo	Gift Box	Boîte Cadeau	Scatola Regalo	Caixa de Presente
	Caucho Termoplástico + Fibras de Polipropileno (PP)	Thermoplastic Rubber + Polipropylene (PP) Fibre	Caoutchouc Thermoplastique + Fibre Polypropylène (PP)	Caucciù Termoplastico + Fibre di Polipropilene (PP)	Borracha Termoplástica + Fibra Polipropileno (PP)



794100

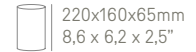

220x160x65mm
8,6 x 6,2 x 2,5"

Soporte Cuchillos Ovalado
Oval Knife Holder // Bloc couteaux
Oval // Porta Coltelli Ovale
Suporte Facas Ovalado



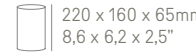

794500



220 x 160 x 65mm
8,6 x 6,2 x 2,5"

Soporte Cuchillos Ovalado
Oval Knife Holder // Bloc Couteaux
Oval // Porta Coltelli Ovale
Suporte Facas Ovalado

 	Caja Regalo	Gift Box	Boîte Cadeau	Scatola Regalo	Caixa
	Bambú	Bamboo	Bambou	Bambú	Bambu

794300



432 x 139 x 39mm
1,5x 17 x5,4"

Soporte Interior Cajón // Knife Holder Drawer // Bloc Universel Tiroir // Porta Coltelli Per Cassetto
Suporte de Bambu Para Gaveta



	Caja Regalo	Gift Box	Boîte Cadeau	Scatola Regalo	Caixa de Presente
	Madera de Caucho Fibras de Polipropileno	Rubberwood Polypropylene Fibers	Bois de Caoutchouc Fibres de Polypropylène	Legno di Gomma Fibre di Polipropilene	Madeira de Borracha Fibras de Polipropileno



794700

 225 x 185 x 150mm
8,8 x 7,2 x 2,3mm

Soporte Cuchillos // Knife Holder
Bloc Couteaux // Porta Coltelli
Suporte Facas

	Caja Regalo	Gift Box	Boîte Cadeau	Scatola Regalo	Caixa de Presente
	Bambú	Bamboo	Bambou	Bambú	Bambu



794800

 150 x 160 x 160mm
5,9 x 6,2 x 6,2"

Soporte Cuchillos // Knife Holder
Bloc Couteaux // Porta Coltelli
Suporte Facas

	Caja Regalo	Gift Box	Boîte Cadeau	Scatola Regalo	Caixa de Presente
	Acero Inoxidable + Fibras de Polipropileno (PP)	Stainless Steel + Polypropylene (PP) Fibre	Acier Inoxydable + Fibre Polypropylène (PP)	Acciaio Inossidabile + Fibre di Polipropilene (PP)	Aço Inoxidável + Fibra Polipropileno (PP)



794900

 220mm/8,6"

 110mm /4,3"

Soporte Cuchillos Redondo
Round Knife Holder // Bloc
Couteaux Rond // Porta Coltelli
Rotondo // Cepo Universal
Redondo // Suporte Facas

	<p>Caja Regalo</p> <p>Piedra Caliza en color Crema Madera de Roble Francés</p>	<p>Gift Box</p> <p>Cream-Colored Limestone French Oak Wood</p>	<p>Boîte Cadeau</p> <p>Pierre Calcaire Crème Bois de Chêne</p>	<p>Scatola Regalo</p> <p>Pietra Calcare di Colore Crema Legno di Rovere Francese</p>	<p>Caixa de Presente</p> <p>Calcário de Cor Creme Madeira de Carvalho Francês</p>
---	--	--	--	--	---



795500



Soporte para Cuchillos de Piedra y Madera // Stone and Wooden Knife Holder // Bloc Couteaux en Pierre et en Bois // Supporto per Coltelli in Pietra e Legno // Suporte para Facas de Pedra e Madeira





SOPORTES MAGNÉTICOS

MAGNETIC RACK
BARRE AIMANTÉE
MAGNET
SUPORTES MAGNÉTICOS

Un lugar muy fiable dónde dejar tus cuchillos son nuestros soportes magnéticos. Tiene un potente imán que sujeta fuertemente las piezas y te permite tenerlas siempre cerca cuidando el estado de tus cuchillos.

Our magnetic knife holders are a very reliable place to leave your knives. They have a strong magnet that securely holds the pieces and allows you to have them always close by, taking care of your knives' condition.

Nos supports magnétiques pour couteaux sont un emplacement sûr pour ranger vos couteaux. Ils ont un aimant puissant qui maintient fermement les pièces en place et vous permet de les avoir toujours à portée de main, en préservant la qualité de vos couteaux.

I nostri supporti magnetici per coltelli sono un luogo molto affidabile dove lasciare i tuoi coltelli. Hanno un magnete potente che tiene saldamente i pezzi e ti permette di averli sempre a portata di mano, curando la condizione dei tuoi coltelli.

Nossos suportes magnéticos para facas são um lugar muito confiável para deixar suas facas. Eles têm um ímã potente que segura firmemente as peças e permite que você as tenha sempre por perto, cuidando da condição de suas facas.

Organización Sencilla

Simple Organization · Organisation Facile · Organizzazione Semplice
Organização Simples.

Previene el Deterioro Prematuro del Cuchillo

Prevents Premature Knife Deterioration · Préviend la Détérioration Prématuurée du Couteau · Previene il Deterioramento Precoce del Coltello · Previne a Deterioração Precoce da Faca.

Potente Imán

Powerful Magnet · Aimant Puissant · Magnete Potente Iman Potente.

Variedad de Diseños

Variety of Designs · Variété de Designs · Varie Design · Variedade de Designs.

	Estuche	Case	Étui	Astuccio	¡ Estojo
	PVC / Acero / ABS	PVC / Steel / ABS	PVC / Acier / ABS	PVC / Acciaio / ABS	PVC / Aço / ABS



692500

 300x45mm/11,8x1,7"

Soporte Magnético // Magnetic Rack // Barre Aimantée // Magnet Suporte Magnético



692600

 450x45mm/17,7x1,7"



Soporte Magnético // Magnetic Rack // Barre Aimantée // Magnet Suporte Magnético



692700

 500x45mm/19,6x1,7"

Soporte Magnético // Magnetic Rack // Barre Aimantée // Magnet Suporte Magnético

	Estuche	Case	Étui	Astuccio	Estojo
	Bambú	Bamboo	Bambou	Bambú	Bambu



692800

 300x45mm/11,8x1,7"

Soporte Magnético // Magnetic Rack // Barre Aimantée // Magnet Suporte Magnético



692900

 450x45mm/17,7x1,7"

Soporte Magnético // Magnetic Rack // Barre Aimantée // Magnet Suporte Magnético

	Estuche	Case	Étui	Astuccio	Estojo
	Madera de Haya	Beechwood	Bois de Hêtre	Legno di Faggio	Madeira de Faia



695000

 400x50mm/15,7x2"

Soporte Magnético // Magnetic Rack // Barre Aimantée // Magnet Suporte Magnético



SACA-CORCHOS

CORKSCREW
TIRE BOUCHON PROF.
CAVATAPPI
SACA-ROLHA

Explora nuestra selección de sacacorchos, desde modelos manuales clásicos hasta opciones eléctricas innovadoras, diseños que combinarán con cualquier estilo de cocina.

Explore our selection of corkscrews, from classic manual models to innovative electric options, designs that will match any kitchen style.

Explorez notre sélection de tire-bouchons, des modèles manuels classiques aux options électriques innovantes, des designs qui s'adapteront à tout style de cuisine.

Esplora la nostra selezione di cavatappi, dai modelli manuali classici alle opzioni elettriche innovative, design che si abbineranno a qualsiasi stile di cucina.

Explore nossa seleção de saca-rolhas, desde modelos manuais clássicos a opções elétricas inovadoras, designs que combinarão com qualquer estilo de cozinha.

Variedad de Diseños

Variety of Designs · Variété de Designs · Varie Design · Variedade de Designs.

Uso Rápido e Intuitivo

Quick and Intuitive use · Utilisation Rapide et Intuitive · Uso Rapido e Intuitivo
Uso Rápido e Intuitivo.

Mantenimiento Simple

Simple Maintenance · Entretien Facile · Manutenzione Semplice
Manutenção Simples.

Materiales Resistentes

Resistant Materials · Matériaux Résistants · Materiali Resistenti
Materiais Resistentes.

	Caja Regalo	Gift Box	Boîte Cadeau	Scatola Regalo	Caixa de Presente
	ABS Aleación de Zinc	ABS Zinc Alloy	ABS Alliage de Zinc	ABS Lega di Zinco	ABS Liga de Zinco



604100

Sacacorchos // Corkscrew
Tire Bouchon Prof // Cavatappi
Saca-Rolhas

Incluye Cortacápsulas / Includes Foil Cutter / Coupe capsule inclus / Comprende Taglia-Capsulei / Inclui corta-cápsulas



607500

Sacacorchos // Corkscrew
Tire Bouchon Prof // Cavatappi
Saca-Rolhas



	Caja Regalo	Gift Box	Boîte Cadeau	Scatola Regalo	Caixa de Presente
	ABS Aleación de Zinc + Elastómero	ABS Zinc Alloy + Elastomer	ABS Alliage de Zinc + Élastomère	ABS Lega di Zinco + Elastomero	Madeira de Borracha Liga de Zinco + Elastómero



604700

Sacacorchos // Corkscrew
Tire Bouchon Prof // Cavatappi
Saca-Rolhas

Incluye Cortacápsulas / Includes Foil Cutter / Coupe capsule inclus / Comprende Taglia-Capsulei / Inclui corta-cápsulas.

 	Caja Regalo	Gift Box	Boîte Cadeau	Scatola Regalo	Caixa de Presente
	604600 ABS 604900 Acero Inoxidable - ABS	604600 ABS 604900 Srainless Steel- ABS	604600 ABS 604900 Acier Inoxydable - ABS	604600 ABS 604900 Acciaio Inossidabile - ABS	604600 ABS 604900 Aço Inoxidável - ABS



604600

Sacacorchos Elec. // Elec. Corkscrew
 Tire Bouchon Prof. Elec. // Cavatappi
 Elec. // Saca-Rolhas Elétrico



604900

Sacacorchos Elec. // Elec. Corkscrew
 Tire Bouchon Prof. Elec. // Cavatappi
 Elec. // Saca-Rolhas Elétrico

Incluye Cargador / Charger Included / Chargeur Fourni / Caricatore Incluso / Inclui carregador

Incluye Cortacápsulas / Includes Foil Cutter / Coupe capsule inclus / Comprende Taglia-Capsulei / Inclui corta-cápsulas.

 	Caja Regalo	Gift Box	Boîte Cadeau	Scatola Regalo	Caixa de Presente
	Aleación Zinc	Zinc Alloy	Alliage de Zinc	Legno di Zinco	Liga de Zinco



603400

195mm/7,6"

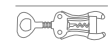

Sacacorchos // Corkscrew
 Tire Bouchon Prof // Cavatappi
 Saca-Rolhas



SOPORTES JAMÓN

HAM HOLDER SUPPORT
SUPPORT À JAMBON
SUPPORTO PROSCIUTTO FRAGGIO
SUPORTE PRESUNTO

Nuestros soportes jamoneros aportan seguridad y versatilidad a tu cocina, ajustándose a cualquier tamaño de jamón o paletilla, y destaca su limpieza sin complicaciones.

Our ham holders provide safety and versatility to your kitchen, adjusting to any size of ham or shoulder, and are notable for their hassle-free cleaning.

Nos supports à jambon offrent sécurité et polyvalence à votre cuisine, s'ajustant à toutes tailles de jambon ou d'épaule et se distinguent par leur facilité d'entretien.

I nostri supporti per prosciutto forniscono sicurezza e versatilità alla tua cucina, adattandosi a qualsiasi dimensione di prosciutto o spalla, e si distinguono per la loro pulizia senza problemi.

Nossos suportes para presunto proporcionam segurança e versatilidade à sua cozinha, ajustando-se a qualquer tamanho de presunto ou paleta, e são notáveis pela sua limpeza descomplicada.

Gran Sujeción y Estabilidad

Great grip and Stability · Grande Prise et Stabilité · Grande Presa e stabilità
Grande Aderência e Estabilidade.

Seguro y fácil de usar

Safe and Easy to Use · Sûr et Facile à Utiliser · Sicuro e Facile da Usare
Seguro e Fácil de Usar.

Diseño Ergonómico

Ergonomic Design · Design Ergonomique · Design Ergonomico
Design Ergonómico.

Materiales resistentes

Resistant Materials · Matériaux résistants · Materiali Resistenti
Materiais Resistentes.

Variedad de Diseños

Variety of Designs · Variété de Designs · Varie Design · Variedade
de Designs.

 	Caja Regalo	Gift Box	Boîte Cadeau	Scatola Regalo	Caixa de Oferta
	Madera de Pino Lacada en Color Caoba Herrajes Metálicos	Mahogany Coloured Pine Lacquered Metallic Ironworks	Bois de Pin Laqué Couleur Acajou Ferrergeries Métalliques	Legno di Pino Laccato di color Mogano Accessori Metallo	Madeira de Pinho Laqueada na Cor Mogno Ferragens Metálicas



683200

 500 x 280 x 180,6mm
19,6 x 11 x 7,1"

Soporte Jamón Pino Lacado
Ham Holder Laquered Pine
Support à Jambon Pin Laqué
Supporto Prosciutto PinoLaccato
Suporte Presunto Pinho Lacado



 	Caja Regalo	Gift Box	Boîte Cadeau	Scatola Regalo	Caixa de Oferta
	Madera de Pino Lacada en Color Natural Herrajes Metálicos	Natural Colour Lacquered Pine Wood Metallic Ironworks	Bois de pin laqué Couleur Naturel Ferrergeries Métalliques	Legno di Pino Laccato di color Naturali Accessori Metallo	Madeira de Pinho Laqueada em Cor Natural Ferragens Metálicas



683300

 500 x 280 x 180,6mm
19,6 x 11 x 7,1"

Soporte Jamón Pino Lacado
Ham Holder Laquered Pine
Support à Jambon Pin Laqué
Supporto Prosciutto PinoLaccato
Suporte Presunto Pinho Lacado

 	Caja Regalo	Gift Box	Boîte Cadeau	Scatola Regalo	Caixa de Presente
	Polietileno PE-500 Acero Inoxidable AISI-304	Polyethylene PE-500 AISI-304 Stainless Steel	Polyéthylène PE-500 Acier Inoxydable AISI-304	Polietileno PE-500 Acciaio Inossidabile AISI-304	Polietileno PE-500 Aço Inoxidável AISI-304



693900

 530 x 386 x 190mm
19,6 x 11 x 7,1"

Soporte Jamón
Ham Holder
Support à Jambon
Supporto Prosciutto
Suporte Presunto

POINT OF SALE DISPLAYS
PRESENTOIRS
EXPOSITORI
EXPOSITORES

www.arcos.com

EXPOSITORES



54221

17 x 37,5cm

Expositor Tablas (Polimetacrilato de Metilo Acrílico) // Cutting Board Display (Polymethyl Methacrylate PMMA) // Prés. Planches à découper (PMMA Polyméthacrylate de Méthyle Acrylique) // Espositore Taglieri (PMMA Polimetacrilato) // Expositor de tábuas (Polimetilmetacrilato PMMA)



54231

45 x 32,8 x 28,8cm

Expositor Sobremesa (Madera y Metacrilato) Counter Display (Wood and Methacrylate) Prés. Comptoir Offices (Bois et Métacrylate) Esp. Multiplo Coltelli (Legno e Metacrilato) Expositor de balcão (Madeira e Metacrilato)



54229

19 x 53,6 x 28,7cm

Exp. Mostrador Mondadores (Madera y Metacrilato) Paring Knives Counter Display (Wood and Methacrylate) Prés. Couteau Office (Bois et Métacrylate) Espositore Coltelli Multiuso (Legno e Metacrilato) Expositor Balcão Descascadores (Madeira e Metacrilato)



54233

30,5 x 37,5 x 16cm

Exp. Mostrador Chuleteros (Madera y Hierro) Steak Knives Counter Display (Wood and Iron) Prés. Couteaux Steak (Bois et Fer) Espositore Coltelli Bistecca (Legno e Ferro) Expositor Balcão para Costoletas (Madeira e Ferro)



54234

29,4 x 25 x 9cm

Exp. Mostrador Cubiertos (Madera y Plástico) Flatware Counter Display (Wood and Plastic) Présentoir Couverts (Bois et Plastique) Espositore Posate (Legno e Plástico) Expositor Balcão Talheres (Madeira e Plástico)



54232

80 x 13cm

Expositor Tira Colgador (Polipropileno) Hanging Display (Polypropylene) Prés. Bande à suspendre (Polypropylène) Espositore Cravatta (Polipropilene) Expositor Tira Peneira (Polipropileno)



54236

54,5 x 171 x 54,5cm

Expositor suelo (Madera y Metal)
Metallic and Wooden Display
Présentoir sol metal et bois
Esp. Da Terra in Legno E Metallo
Exp. Solo Metálico e Madeira



54235

86 x 195 x 86cm

Exp. Cazuelas, Sartenes y Cuchillos (Madera y Metal)
(Metallic and Wooden) Cookware and Knives Display
Prés. Casseroles, poêles et couteaux (Metal et Bois)
Esp. Padelle, Pentole E Coltelli (Legno E Metallo)
Expositor Tachos, Frigideiras E Facas (Metálico e Madeira)



54237

54,5 x 171 x 54,5cm

Expositor suelo (Madera y Metal)
(Metallic and Wooden) Display
Présentoir sol (Metal et Bois)
Espositore Da Terra In Legno (Legno E Metallo)
Exp. Solo (Metálico e Madeira)



54217

145 x 60 x 10cm

Expositor Vitrina Pared (Hierro y Cristal)
Wall Display (Iron and Glass)
Présentoir Vitrine Murale (Fer et Verre)
Espositore vetrina da parete (Ferro e Vetro)
Expositor Vitrine Parede (Ferro e Vidro)



REF :	PÁG:	REF :	PÁG:	REF :	PÁG:	REF :	PÁG:	REF :	PÁG:
100100 102	152600 92	185701 227	188622 105	211900 72
100101 102	160100 42	185721 227	188623 105	212000 73
100400 102	160400 42	185722 227	188624 105	212100 73
100401 102	160600 42	185723 227	188625 105	212200 74
100500 102	160800 42	185725 227	188628 105	212300 74
100501 102	161100 42	185900 230	188631 105	223300 49
100600 103	161300 43	185901 230	188632 105	224900 48
100601 103	161400 43	185924 230	188633 105	225000 49
100700 103	161600 43	186000 228	188634 105	225100 50
100701 103	161900 43	NEW 187000 110	188676 105	225200 50
100800 103	162000 42	187900 106	188677 105	225300 50
100801 103	162300 43	188000 106	188678 105	225600 48
101300 103	162600 43	188100 106	188700 106	225700 48
101301 103	NEW 163200 44	188200 106	188800 106	225800 49
101500 103	163300 44	188300 105	188821 106	225900 49
101501 103	164900 54	188301 105	188822 106	226000 49
102500 102	165000 54	188321 105	188823 106	226200 48
102501 102	165100 54	188322 105	188824 106	226400 48
102700 102	NEW 165300 54	188323 105	188825 106	226500 49
102701 102	165400 55	188325 105	188900 107	226600 48
134900 97	NEW 165500 54	188400 105	189000 108	226700 50
135000 95	165900 55	188401 105	189100 108	226800 50
135200 95	166100 54	188421 105	189421 108	226900 48
135300 95	166400 55	188422 105	189422 108	227000 51
135400 95	166600 56	188500 105	189500 109	228700 51
135500 96	166700 55	188501 105	189621 109	229900 48
135600 96	166800 55	188510 105	189622 109	230200 60
135700 96	167000 57	188521 105	189700 109	230224 66
135800 95	167100 57	188522 105	NEW 189800 110	230500 60
136100 97	167200 56	188523 105	NEW 189900 110	230524 66
136500 97	NEW 167400 54	188524 105	190123 36	230600 60
136700 96	168000 56	188525 105	190423 36	230624 66
150200 90	168100 56	188528 105	190623 36	231000 62
150300 90	168200 56	188576 105	190823 36	231024 68
150500 90	181300 272	188577 105	191123 36	231100 62
150700 90	185300 230	188578 105	191323 37	231124 68
150800 90	185301 230	188600 105	191623 37	231300 62
150900 90	185324 230	188601 105	191923 37	231324 68
151000 91	185400 228	188610 105	192023 37	231500 62
151200 91	185500 228	188611 105	192623 37	231524 68
151400 91	185601 225	188612 105	194000 38	232000 60
151500 91	NEW 185610 226	188613 105	210100 72	232024 66
151600 91	185621 225	188614 105	210400 72	232800 60
151900 92	185622 226	188615 105	210600 72	232824 66
152000 93	185623 226	188618 105	210700 72	232900 62
152100 93	185625 226	188621 105	211100 72	232924 68

REF :	PÁG:	REF :	PÁG:	REF :	PÁG:	REF :	PÁG:	REF :	PÁG:
233000 62	242800 126	280504 79	286004 82	290521 130
233024 68	242900 126	280601 79	286104 85	290522 130
233100 61	243000 123	280604 79	286204 85	290523 130
233124 67	243100 122	280704 80	286304 85	290525 130
233200 61	243200 122	280804 80	286400 85	290600 135
233224 67	243500 126	281004 76	286500 85	290621 135
233300 60	244100 123	281104 76	286600 84	290622 135
233324 66	245400 125	281204 77	286700 116	290623 135
233400 61	260200 114	281304 77	286800 116	290625 135
233424 67	260300 114	281404 77	287000 117	290700 131
233500 61	260400 114	281504 77	287100 117	290721 131
233524 67	262400 114	281604 78	287200 117	290722 131
233600 61	263000 113	281704 78	287300 118	290723 131
233624 67	263100 113	281801 81	287800 117	290724 131
233700 61	263200 113	281804 81	287900 117	290725 131
233724 67	263400 113	281901 81	287400 118	290728 131
233800 61	263600 113	281904 81	288200 84	290800 131
233824 67	270800 113	282004 81	288300 84	290821 131
234200 63	271300 114	282104 80	288400 83	290822 131
234300 63	277000 114	282204 80	288804 82	290823 131
234524 69	277100 261	282404 84	289004 76	290824 131
235024 69	277200 265	282504 76	289104 77	290825 131
240000 122	278100 284	282604 76	289704 82	290828 131
240100 124	278138 284	282704 76	289804 82	290900 131
240200 124	278200 284	282904 116	289904 82	290921 131
240300 124	278400 284	283004 116	290000 130	290922 131
240500 124	278510 285	283104 116	290021 130	290923 131
240600 124	278511 285	283204 116	290022 130	290925 131
240700 124	278512 285	283304 116	290023 130	291100 139
240800 124	278513 285	283704 83	290025 130	291125 139
241000 122	278514 285	283804 81	290031 130	291200 136
241100 122	278515 285	283904 80	290100 130	291222 136
241200 122	279010 285	284004 83	290121 130	291223 136
241300 122	279200 284	284100 78	290122 130	291225 136
241400 123	279202 284	284204 77	290123 130	291300 136
241500 123	279400 284	284304 80	290125 130	291322 136
241600 123	NEW 279600 285	284604 78	290300 135	291323 136
241700 123	NEW 279623 285	284704 78	290325 135	291325 136
242000 125	NEW 279900 285	284804 78	290400 130	291400 138
242100 125	NEW 279923 285	285000 87	290421 130	291424 138
242200 125	280004 76	285100 88	290422 130	291425 138
242300 125	280104 76	285500 86	290423 130	291431 138
242500 125	280204 79	285600 87	290425 130	291500 133
242600 126	280304 79	285700 88	290431 130	291522 133
242700 126	280404 79	285800 86	290500 130	291523 133

REF :	PÁG:	REF :	PÁG:	REF :	PÁG:	REF :	PÁG:	REF :	PÁG:
291525 133	292400 134	293625 138	295123 135	297522 141
291600 133	292422 134	293700 138	295125 135	297525 141
291622 133	292423 134	293724 138	295200 135	298500 140
291623 133	292425 134	293725 138	295222 135	298800 140
291625 133	292500 134	293800 139	295223 135	298825 140
291700 133	292523 134	293825 139	295225 135	299500 142
291722 133	292525 134	293900 139	295300 137	299525 142
291723 133	292600 137	293925 139	295322 137	299600 142
291725 133	292622 137	294000 136	295323 137	299625 142
291800 133	292623 137	294022 136	295325 137	299700 142
291822 133	292625 137	294025 136	295400 137	299725 142
291823 133	292700 137	294100 136	295422 137	370000 185
291825 133	292721 137	294122 136	295423 137	370025 185
291900 133	292722 137	294125 136	295425 137	370100 183
291922 133	292723 137	294200 136	295500 135	370200 183
291923 133	292725 137	294225 136	295522 135	370500 185
291925 133	292800 137	294400 130	295525 135	370525 185
292000 131	292822 137	294422 130	295700 140	370600 185
292021 131	292823 137	294425 130	295725 140	370625 185
292022 131	292825 137	294500 136	295800 134	NEW 371400 161
292023 131	292900 132	294521 136	295822 134	371500 161
292025 131	292922 132	294522 136	295823 134	371501 161
292100 130	292923 132	294523 136	295825 134	NEW 371600 161
292110 130	292925 132	294524 136	295900 134	371601 161
292115 130	293000 132	294525 136	295922 134	NEW 371700 161
292121 130	293022 132	294600 132	295923 134	371800 159
292122 130	293023 132	294622 132	295925 134	371822 159
292123 130	293025 132	294623 132	296000 134	371823 159
292124 130	293100 135	294625 132	296022 134	NEW 371900 159
292125 130	293123 135	294700 132	296023 134	372000 164
292128 130	293125 135	294722 132	296025 134	NEW 372100 159
292131 130	293200 138	294723 132	296100 141	372200 165
292200 131	293224 138	294725 132	296122 141	372300 166
292210 131	293225 138	294800 132	296123 141	372400 169
292215 131	293300 139	294822 132	296125 141	372500 162
292221 131	293322 139	294823 132	296510 132	372600 162
292222 131	293323 139	294825 132	296515 132	372700 162
292223 131	293325 139	294900 139	296700 141	372900 169
292224 131	293400 139	294925 139	296722 141	NEW 373000 159
292225 131	293422 139	295000 138	296723 141	373300 169
292228 131	293425 139	295024 138	296725 141	NEW 373424 100
292300 131	293500 139	295025 138	297200 141	373624 99
292321 131	293525 139	295028 138	297222 141	373631 99
292322 131	293600 138	295100 135	297225 141	373632 100
292325 131	293624 138	295122 135	297500 141	373700 149

REF :	PÁG:	REF :	PÁG:	REF :	PÁG:	REF :	PÁG:	REF :	PÁG:
373723 149	485300 145	562100 209	587200 205	607100 271
373728 149	485329 145	562400 211	587400 204	607200 271
373800 179	485700 145	562500 211	595000 196 <small>NEW</small>	607300 272
373900 150	485729 145	565600 154	595100 196 <small>NEW</small>	607420 272
373923 150	485900 145	570100 214	595200 195	607500 303
373928 150	485929 145	570200 213	595300 196	610700 282
374000 179	500600 234	570300 214	595400 198	610000 281
<small>NEW</small> 374200 162	501100 234	570400 215	595500 196	610200 281
374610 164	502200 233	570600 213	595600 195	610600 281
374700 170	502300 233	570700 214	595700 196	612100 272
374710 164	502400 233	570800 215	595800 198	612200 266
374722 170	504200 234	570900 213	595900 195	612300 266
374724 170	504300 234	570902 213	596000 196	612700 266
374800 170	506100 223	571000 214	596100 198	612800 267
374822 170	507010 221	571100 215	596200 195	613000 266
374824 170	507100 221	572100 214	596300 198	613100 266
375000 171	513500 231	572400 215	596600 197	613200 267
375100 171	516500 231	574100 217	596700 188	613300 270
375200 169	521000 231	574200 217	596800 197	613400 270
375500 153	539000 223	574300 216	596900 197	613600 265
375800 153	539100 223	574400 217	597000 197	613700 268
375900 154	541300 192	574500 216	597100 197	613800 268
376500 153	541500 192	574600 217	597200 197	614200 267
376900 154	541600 192	574700 216	597300 198	614300 267
377000 167	541700 192	574800 216	597400 199	614400 267
377100 166	542000 193	574900 216	597500 199	614500 268
377200 173	560100 208	575000 216	597600 195	614600 268
377400 156	560200 207	585000 202	603000 276	614800 268
377600 167	560300 208	585100 202	603400 304	615000 288
377700 167	560400 210	585200 201	603500 276	615100 288
<small>NEW</small> 377900 155	560500 208	585400 203	603600 276	615200 288
378000 156	560600 207	585600 201	603900 282	615300 288
378100 156	560700 208	585700 202	604100 303	615400 288
378200 156	560800 210	585800 203	604500 276	616600 266
378400 156	560900 207	585900 201	604600 304	616800 267
<small>NEW</small> 379300 99	560902 207	586000 202	604700 303	617100 273
<small>NEW</small> 379400 99	561000 208	586100 203	604900 304	617200 273
<small>NEW</small> 379500 99	561100 210	586200 201	605000 270	683200 306
460100 181	561200 207	586300 203	605100 269	683300 306
460400 181	561300 210	586400 201	606100 269 <small>NEW</small>	685000 275
<small>NEW</small> 479200 189	561600 209	586600 202	606200 269 <small>NEW</small>	685100 275
<small>NEW</small> 479400 189	561700 210	586700 203	606300 269 <small>NEW</small>	685200 275
<small>NEW</small> 479500 189	561800 209	586800 202	606400 270 <small>NEW</small>	685300 275
<small>NEW</small> 479600 189	561900 209	586900 204	606500 269 <small>NEW</small>	685400 275
<small>NEW</small> 480100 190	562000 209	587000 204	607000 271 <small>NEW</small>	685500 275

REF:	PÁG:	REF:	PÁG:	REF:	PÁG:	REF:	PÁG:
NEW 685600 277	714500 257	719800 248	805900 50
689900 262	714600 257	740009 171	806100 107
690200 293	714900 258	765000 290	806200 107
690400 293	715000 258	765100 290	807000 151
690500 293	715100 258	765200 290	807100 151
691400 293	715200 258	765300 290	807200 151
691510 290	715300 258	766100 291	807410 86
691610 290	715400 259	766200 291	809700 223
691710 290	715500 257	766300 291	809800 223
691810 290	715800 259	780800 265	830400 166
692210 291	716010 240	782100 285	830600 173
692310 291	716110 240	784901 225	830700 174
692500 301	716210 240	784911 225	830800 174
692600 301	716310 240	790200 261	NEW 834200 63
692700 301	716410 241	790500 261	838310 63
692800 301	716510 241	790600 263	838410 69
692900 301	716610 241	790800 263	NEW 849300 100
693810 291	716710 241	790900 119	858100 44
693900 306	716810 242	791600 262	858110 38
694800 294	716910 242	791800 263	859800 107
694900 294	717010 242	792300 119	54217 309
695000 301	717110 242	792400 119	54221 308
695100 294	717210 243	792921 111	54229 308
NEW 697400 259	717310 243	793100 227	54231 308
NEW 697500 244	717410 243	793800 296	54232 308
NEW 697900 252	717510 243	794000 296	54233 308
701000 153	717810 244	794100 297	54234 308
701800 155	718000 248	794300 297	54235 309
701900 155	718100 248	794400 296	54236 309
702000 153	718200 248	794500 297	54237 309
702100 154	718300 249	794700 298	2873000 118
702300 156	718400 249	794800 298	2874000 119
708000 290	718500 249	794900 298	2875000 119
708100 290	718600 249	795000 322	2878000 119
708200 290	718700 250	795100 261	2879000 118
708300 290	718800 250	795500 299	7198000 252
709100 291	718900 250	802900 183		
709200 291	719000 250	802910 183		
709300 291	719100 250	803000 171		
709600 291	719200 250	803700 163		
714000 256	719300 251	803800 163		
714100 256	719400 251	803900 163		
714200 256	719500 251	804000 172		
714300 256	719600 251	804100 172		
714400 257	719700 251	805109 172		

CALIDAD

QUALITÀ
QUALITY
QUALITÉ
QUALIDADE

✓ 10 YEAR GUARANTEE

Desde su nacimiento Arcos Hermanos ha trabajado por la mejora constante del nivel de calidad de sus productos. Un equipo humano con una formación excelente y una larga trayectoria profesional, se encarga de automatizar los procesos de trabajo para alcanzar el mejor rendimiento y control, y así lograr los máximos estándares de calidad. El Certificado ISO 9001:2015 lo corrobora y reconoce internacionalmente. Además, ARCOS dispone también de un Registro Sanitario (39.03065/AB), y la prestigiosa certificación norteamericana NSF (National Sanitary Foundation).
ARCOS HNOS. S.A. GARANTIZA SUS PRODUCTOS DURANTE DIEZ AÑOS, contra todo defecto de fabricación, siempre que se haga uso racional de la pieza para el cual está fabricada.

Since our birth as a company, Arcos Hermanos has always strived for the constant improvement of quality in all its products. Our highly specialized and well trained team of professionals constantly strives to improve our manufacturing processes and techniques in order to achieve the highest output and control with the highest quality standards. This is how Arcos achieves our goal of the highest quality standards of all our products. Our ISO 9001:2015 certification confirms and recognizes our international standards of quality control. Arcos also has a national Registry Health Number (39.03065/AB) and has gained the prestigious certification from the NSF (National Sanitary Foundation), an American organization which certifies our products as suitable and safe to be in contact with food.
ARCOS HNOS. S.A. WARRANTS ITS PRODUCTS against defects in material and workmanship under normal and proper use FOR A PERIOD OF TEN YEARS.

Depuis sa naissance, Arcos Hermanos a constamment cherché à améliorer le niveau de qualité de ses produits. Son équipe humaine, d'excellente formation, acquise à travers leur expérience professionnelle, se charge de l'automatisation des procédés de travail afin d'obtenir le meilleur rendement et contrôle permettant par conséquent d'atteindre les maximums standards de qualité. Le Certificat ISO 9001:2015 reflète cette exigence de qualité reconnue mondialement.
ARCOS HNOS. S.A. GARANTIE QUE SES PRODUITS PENDANT DIX ANS, contre tout défaut de fabrication, dans un usage normal d'utilisation. De plus, ARCOS dispose d'un Registre Sanitaire (39.03065/AB), et de la prestigieuse certification nord-américaine NSF (National Sanitary Foundation).

Fino dalla sua nascita, Arcos Hermanos ha lavorato con la finalità di migliorare costantemente il livello di qualità dei suoi prodotti. Un gruppo umano con una formazione eccellente e una grande professionalità è incaricato della automatizzazione dei processi di lavorazione al fine di ottenere il massimo rendimento e controllo produttivo, unitamente al perfezionamento continuo e costante della qualità. Il Certificato ISO 9001:2015 è a testimoniare questo riconoscimento internazionale.



Inoltre ARCOS si fregia del diploma emesso dal Registro Sanitario (39.03065/AB), unitamente alla prestigiosa esclusiva Certificazione U.S.A. NSF (National Sanitary Foundation)
ARCOS HNOS. S.A., in Avda Gregorio Arcos, s/n – ALBACETE-Spagna, GARANTISCE TUTTI I SUOI PRODOTTI PER 10 ANNI, contro tutti i difetti di fabbricazione, purchè si faccia uso corretto dell'utensile per il quale lo stesso è stato prodotto.

Desde o seu nascimento, a Arcos Hermanos tem trabalhado para melhorar constantemente o nível de qualidade dos seus produtos. Uma equipa com excelente formação e uma longa carreira profissional, é responsável pela automatização dos processos de trabalho para alcançar o melhor desempenho e controlo, e assim alcançar os mais elevados padrões de qualidade. O certificado ISO 9001:2015 corrobora e reconhece isto internacionalmente. Além disso, a ARCOS também tem um Registo Sanitário (39.03065/AB), e a prestigiada certificação americana NSF (National Sanitary Foundation).
ARCOS HNOS. S.A. GARANTE OS SEUS PRODUTOS PARA DEZ ANOS, contra todos os defeitos de fabrico, desde que a peça para a qual é fabricada seja utilizada racionalmente.

DISEÑO E INNOVACIÓN

DESIGN AND INNOVATION
DESSIN ET INNOVATION
DESIGN E INNOVAZIONE
DESIGN E INOVAÇÃO

ARCOS HERMANOS es una empresa cuyo compromiso con el Diseño se ha visto reconocido a través de numerosos premios. Fuimos galardonados con el Premio Castilla-La Mancha de Diseño en el año 2007 y estuvimos nominados a los Premios Nacionales de Diseño, un galardón que se encuentra dentro de los más importantes dentro de nuestro país y que es otorgado por el Ministerio de Industria, Turismo y Comercio y la Fundación Barcelona Centre de Disseny. El diseño es para nosotros una pieza fundamental en nuestro trabajo. Al igual que la innovación, que juega un papel crucial dentro de nuestra compañía y se ha convertido en una herramienta estratégica indispensable a la hora de trabajar. Queremos ofrecer nuevas alternativas que mejoren la vida de nuestros clientes. Un ejemplo de ello es el acero exclusivo NITRUM®, una apuesta que nos ha convertido en pioneros en utilizar este tipo de material.

ARCOS HERMANOS is a company whose commitment to design has been recognised with numerous awards. The company was awarded the Castile-La Mancha Design Awards in 2007 and was nominated for the National Design Awards, an award which is among one of the most important in our country and which is awarded by the Ministry of Industry, Tourism and Commerce and the BCF (Barcelona Centre de Disseny) Foundation. The design is for us a cornerstone in our work. Just like innovation, it plays a crucial role within our company and has become an indispensable strategic tool when it comes to working. We want to offer new alternatives which will improve the lives of our customers. One such example is the exclusive steel NITRUM®, a commitment which has made ARCOS pioneers in using this type of material.

ARCOS HERMANOS est une société très primée pour son engagement dans le Design. Nous avons reçu le Prix Castille-La Manche du Design en 2007 et nous avons été nominés aux Prix Nationaux Design, l'un des principaux prix en Espagne, décerné par le Ministère de l'industrie, du Tourisme et du Commerce et par la Fondation Barcelona Centre de Disseny. Pour nous, le design est un élément essentiel dans notre travail. Il en est de même pour l'innovation, qui joue un rôle central dans notre société et qui est devenue un outil stratégique indispensable dans notre travail. Nous souhaitons proposer de nouvelles alternatives capables d'améliorer la vie de nos clients. L'acier exclusif NITRUM® en est un bon exemple, car c'est un pari qui a fait de nous des pionniers dans l'utilisation d'un matériau de cette nature. L'impegno posto dalla ditta ARCOS HERMANOS nel Design è stato



riconosciuto con molti premi. Nel 2007 ricevemmo il Premio Castilla-La Mancha di Design e fummo nominati ai Premi Nazionali di Design, un premio fra i più importanti nel nostro Paese e concesso dal Ministero dell'Industria, del Turismo e del Commercio e dalla Fondazione Barcelona Centre de Disseny. Per noi il design è un elemento fondamentale del nostro lavoro. Come l'innovazione, che gioca un ruolo fondamentale nella nostra compagnia ed è diventata uno strumento strategico indispensabile per il lavoro. Vogliamo offrire nuove alternative che migliorino la vita dei nostri clienti. Un esempio è l'acciaio esclusivo NITRUM®, una scommessa che ci ha fatti diventare dei pionieri nell'utilizzo di questo tipo di materiale.

ARCOS HERMANOS is a company whose commitment to design has been recognised with numerous awards. The company was awarded the Castile-La Mancha Design Awards in 2007 and was nominated for the National Design Awards, an award which is among one of the most important in our country and which is awarded by the Ministry of Industry, Tourism and Commerce and the BCF (Barcelona Centre de Disseny) Foundation. The design is for us a cornerstone in our work. Just like innovation, it plays a crucial role within our company and has become an indispensable strategic tool when it comes to working. We want to offer new alternatives which will improve the lives of our customers. One such example is the exclusive steel NITRUM®, a commitment which has made ARCOS pioneers in using this type of material.

SERVICIO

SERVICE
PROCESSUS ET MATÉRIAUX
SERVIZIO
PROCESSOS E MATERIAIS



Una estrecha relación con el cliente es uno de los pilares de nuestra empresa. Mantener un buen trato con ellos y satisfacer sus necesidades es algo en lo que hacemos mucho hincapié y por ello dedicamos un gran esfuerzo en el tema de logística. Un buen sistema de producción mejora los tiempos de preparación y envío, por eso ponemos toda nuestra confianza en las mejores compañías de mensajería urgente. Esto nos asegura que nuestros productos lleguen en las mejores condiciones y en los tiempos estimados.

A close relationship with the customer is one of the cornerstones of our company. Maintaining good customer service and meeting their needs is something in which we go to great lengths to lay considerable emphasis on and it is for this reason that we devote a great deal of effort as regards logistics. A good production system improves preparation and shipping times, that is why all our trust is placed in the best express courier companies. This ensures that our products arrive in the very best conditions and on-time as per scheduled delivery deadlines.

L'un des piliers essentiels de notre entreprise repose sur la proximité avec nos clients. Nous attachons une grande importance à entretenir des relations solides avec eux et à répondre à leurs besoins. C'est la raison pour laquelle nous investissons considérablement dans notre logistique. Un système de production efficace nous permet d'optimiser les délais de préparation et d'expédition. C'est pourquoi nous faisons entièrement confiance aux meilleures sociétés de transport. Nous veillons ainsi à ce que nos produits parviennent à destination dans les meilleures conditions et dans les délais impartis.

Uno stretto rapporto con il cliente è uno dei pilastri della nostra ditta. Insistiamo molto nel trattare bene i clienti e soddisfare le loro necessità e, per questa ragione, ci sforziamo molto nel campo della logistica. Un buon sistema di produzione migliora i tempi di preparazione ed invio, per questo abbiamo completa fiducia nelle migliori ditte di corrieri espressi. Ciò garantisce che i nostri prodotti arrivino nelle migliori condizioni e rispettando i tempi stimati.

Uma estreita relação com o cliente é um dos pilares da nossa empresa. Manter uma boa relação com eles e satisfazer as suas necessidades é algo em que damos grande ênfase, razão pela qual investimos muito esforço na logística. Um bom sistema de produção melhora os tempos de preparação e entrega, razão pela qual depositamos toda a nossa confiança nas melhores empresas de correio expresso. Isto assegura que os nossos produtos chegam nas melhores condições e dentro do prazo.

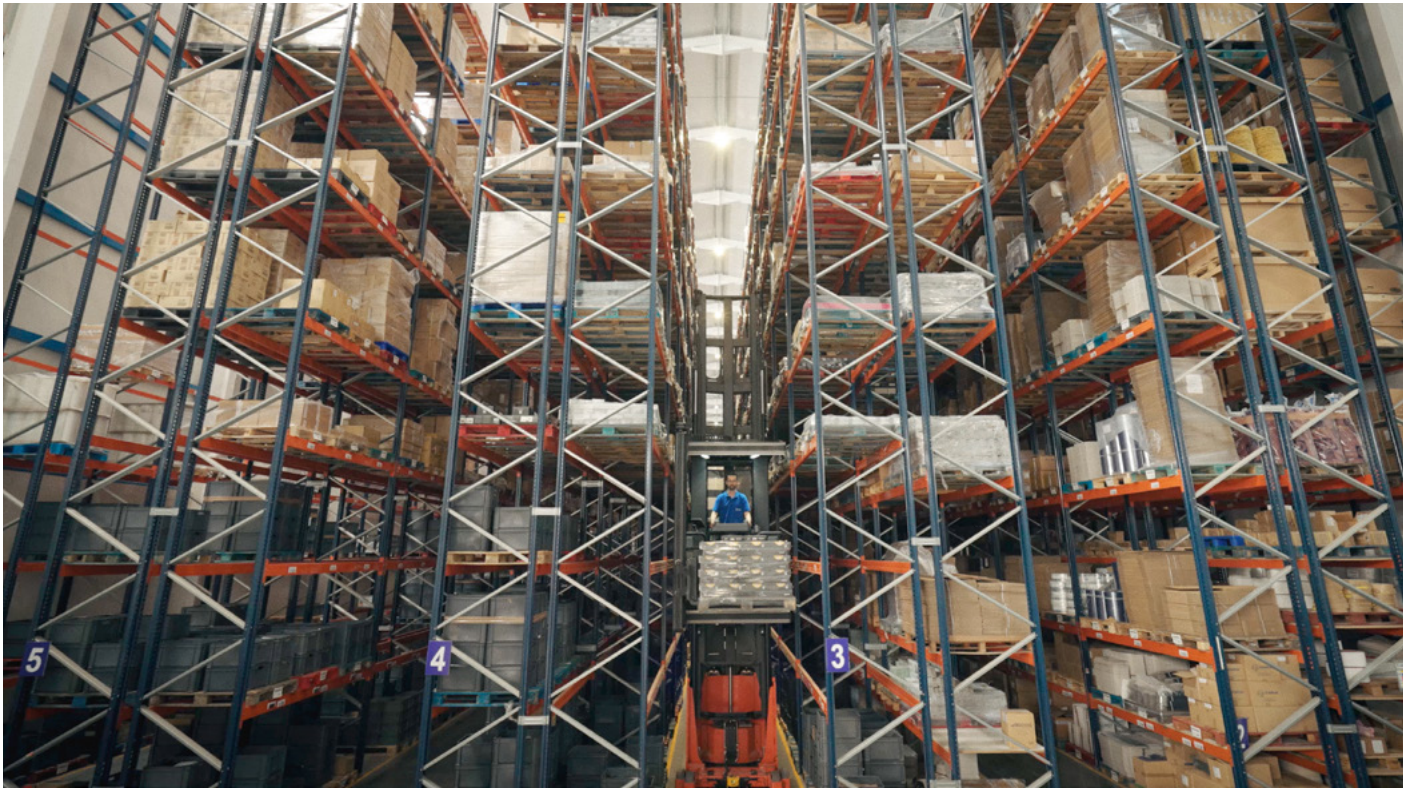

Almacén de materia prima con capacidad de 7.000 palets. // Raw material warehouse with a capacity of 7,000 pallets.

SOSTENIBILIDAD

SUSTAINABILITY
DURABILITÉ
SOSTENIBILITÀ
SUSTENTABILIDADE

En ARCOS Hermanos, nos comprometemos con la sostenibilidad como un valor fundamental. Estamos trazando un camino hacia un packaging más ecoamigable, comenzando por reemplazar el plástico por opciones de cartón reciclable, lo que representa un avance significativo en nuestra estrategia de reducción de residuos y promoción del reciclaje.

Nuestros programas educativos sobre el cuidado y mantenimiento de cuchillos buscan prolongar la vida útil de estos productos, disminuyendo la necesidad de reemplazos frecuentes. Además, en la fabricación, empleamos madera certificada FSC y reciclamos eficientemente los materiales sobrantes. Optimizamos el uso de recursos hídricos y energéticos, incluyendo energía 100% renovable.

Nuestro enfoque hacia la reducción de la huella de carbono también se refleja en iniciativas de compensación ambiental, como la plantación de árboles en proyectos de reforestación, contribuyendo a mitigar el impacto del cambio climático.

El bienestar de nuestros empleados es una prioridad, promovido a través del Arcos Sport Club y programas de salud. Nuestro Plan de Igualdad y estrategias de diversidad e inclusión aseguran un ambiente laboral equitativo. Colaboramos con centros ocupacionales para fomentar la inclusión laboral de personas con discapacidades, reafirmando nuestro compromiso con una sociedad más inclusiva y sostenible.

En ARCOS, nos alineamos con los Objetivos de Desarrollo Sostenible específicos, integrándolos en nuestro plan estratégico para avanzar hacia un futuro más sostenible y equitativo.

At ARCOS Hermanos, we are committed to sustainability as being a basic value. We are tracing a path towards more eco-friendly packaging, by starting to replace plastic with recyclable cardboard options, which is a major step forward in our strategy to reduce waste and promote recycling.

Our educational programmes on knife care and maintenance are aimed at prolonging the lifespan of these products, and therefore cut down on the need to replace them so often. Furthermore, in the manufacturing, we use FSC certified wood and we efficiently recycle the left over materials. We optimize the use of water and energy resources, by including 100% renewable energy.

Our approach on reducing the carbon footprint is also conveyed in environmental compensation initiatives, such as planting trees in reforestation projects, which helps mitigate the impact of climate change.

The well-being of our employees is a priority, which is promoted through the Arcos Sport Club and health programmes. Our Equality Plan and diversity and inclusion strategies ensure an equal and fair working atmosphere. We collaborate with occupational therapy centres to promote the inclusion of people with disabilities into the workforce, which reaffirms our commitment with a more inclusive and sustainable society.

At ARCOS, we meet specific Sustainable Development Objectives, by including them in our strategic plan to make progress towards a more sustainable and equitable future.



Chez ARCOS Hermanos, nous sommes engagés pour la durabilité comme valeur fondamentale. Nous traçons la voie vers des emballages plus respectueux de l'environnement, en commençant par le remplacement du plastique par des options en carton recyclable, ce qui constitue une étape importante dans notre stratégie de réduction des déchets et de promotion du recyclage.

Nos programmes éducatifs sur le soin et l'entretien des couteaux visent à prolonger la durée de vie de ces produits, de sorte à réduire le besoin fréquent de remplacement. De plus, nous utilisons du bois certifié FSC dans la fabrication et recyclons efficacement les matériaux restants. Nous optimisons l'exploitation des ressources en eau et en énergie, moyennant l'intégration des énergies 100 % renouvelables.

Notre approche de la réduction de notre empreinte carbone se reflète également dans des initiatives de compensation environnementale, telles que la plantation d'arbres dans des projets de reboisement, contribuant ainsi à atténuer les effets du changement climatique.

Le bien-être de nos équipes est une priorité, promue par le biais d'Arcos Sport Club et de programmes de santé. Notre plan d'égalité et nos stratégies de diversité et d'inclusion permettent de garantir un environnement de travail équitable. Nous collaborons avec des centres d'activités afin d'encourager l'inclusion professionnelle des personnes handicapées, réaffirmant ainsi notre engagement en faveur d'une société plus inclusive et durable.

Chez ARCOS, nous nous alignons sur des objectifs de développement durable spécifiques, en les intégrant dans notre plan stratégique pour progresser vers un avenir plus durable et plus équitable.



ARCOS si allinea con gli specifici Obiettivi di Sviluppo Sostenibile, integrandoli nel suo piano strategico per avanzare verso un futuro più sostenibile ed equo.

Na ARCOS Hermanos, estamos comprometidos com a sustentabilidade como um valor fundamental. Estamos a traçar um caminho para embalagens mais amigas do ambiente, começando por substituir o plástico por opções de cartão reciclável, o que representa um passo significativo na nossa estratégia para reduzir os resíduos e promover a reciclagem.

Os nossos programas de educação sobre cuidados e manutenção de facas têm como objetivo prolongar a vida útil das nossas facas, reduzindo a necessidade de substituições frequentes. Além disso, utilizamos madeira certificada FSC no fabrico e reciclamos eficazmente os materiais que sobram. Optimizamos a utilização de recursos hídricos e energéticos, incluindo 100% de energia renovável.

A nossa abordagem à redução da nossa pegada de carbono também se reflete em iniciativas de compensação ambiental, como a plantação de árvores em projetos de reflorestação, ajudando a mitigar o impacto das alterações climáticas.

ARCOS Hermanos si impegna nella sostenibilità come valore fondamentale. Stiamo tracciando il cammino verso un packaging maggiormente eco-compatibile, cominciando dalla sostituzione della plastica con opzioni di cartone riciclabile e ciò rappresenta un progresso significativo nella nostra strategia di riduzione dei residui e di promozione del riciclaggio.

I nostri programmi educativi sulla cura e manutenzione dei coltelli hanno lo scopo di prolungare la vita utile di questi prodotti, diminuendo così la necessità di sostituirli frequentemente. Durante il processo di produzione, inoltre, utilizziamo legno certificato FSC e ricicliamo efficientemente i materiali in eccesso. Ottimizziamo l'uso di risorse idriche ed energetiche, impiegando energia rinnovabile al 100%.

In nostro approccio alla riduzione progressiva dell'impronta di carbonio si rispecchia anche nelle iniziative di compensazione ambientale, come il piantare alberi nel seno di progetti di rimboschimento che contribuiscono a mitigare l'impatto del cambiamento climatico.

Il benessere dei nostri dipendenti è una priorità e lo promuoviamo tramite l'Arcos Sport Club e dei programmi di salute. Il nostro Piano per la Parità e le nostre strategie per la diversità e l'inclusione assicurano un ambiente di lavoro equo. Collaboriamo con centri per l'occupazione al fine di promuovere l'inserimento professionale di persone diversamente abili, a conferma del nostro impegno per una società più inclusiva e sostenibile.



ARCOS EN EL MUNDO

ARCOS WORLDWIDE
ARCOS DANS LE MONDE
ARCOS NEL MONDO
ARCOS PELO MUNDO

ARCOS Hermanos tiene una superficie de trabajo dividida en diferentes plantas dentro de la provincia de Albacete (España). Podríamos decir que nuestra empresa no tiene fronteras, ya que podemos encontrar nuestros productos en cualquiera de los continentes. Operando en 94 países, ARCOS Hermanos distribuye sus piezas por todo el mundo, lo que nos convierte en la empresa líder de cuchillería, tanto profesional como de uso doméstico, cuyo nombre es conocido en todas partes. Queremos dejar nuestra huella y el éxito y calidad de nuestros productos nos hace viajar sin límites.

En la actualidad, cuenta con un equipo humano de cerca de 500 personas, que fabrican 1.100 modelos diferentes de cuchillos y una media de 75.000 piezas diarias. En una superficie de más de 30.000 m², dividida en distintas plantas en la provincia de Albacete (España), se levanta esta industria.

Trabaja con la última tecnología de fabricación y la actualiza constantemente, para que el nivel de calidad de cada producto sea siempre óptimo. Así pues, se consolida como empresa líder de cuchillería, tanto profesional como de uso doméstico.

ARCOS Hermanos has a work surface area divided into different plants within the province of Albacete (Spain). It can be said that our company has no borders, given that one can find our products in every continent. Operating in 94 countries, ARCOS Hermanos distributes its pieces worldwide, making us the leading cutlery-knife making company, both professional as well as national level, whose name is known everywhere. We want to leave our mark and the success and quality of our products confers on us the freedom of limitless movement.

Our team of almost five hundred employees produces 1.100 different models of knives with a production average of 75,000 units per day. Our production process is divided between several factories located in the province of Albacete (Spain) with a total factory production area of over 30,000 square meters.

Because we work with the latest technologies and are constantly updating them to ensure the highest quality of our products, Arcos Hermanos, S.A. has become a Global leader in the development of professional and well as home cutlery.

ARCOS Hermanos a un espace de travail composé de plusieurs usines réparties dans la province d'Albacete (Espagne). Nous sommes en mesure d'affirmer que notre société n'a pas de frontières car nos produits se trouvent dans tous les continents. Présente dans 94 pays, ARCOS Hermanos distribue ses produits dans le monde entier, ce qui fait de nous la société leader dans le secteur coutellerie, tant professionnelle que domestique, sous un nom mondialement connu. Nous souhaitons laisser notre empreinte, et le succès et la qualité de nos produits nous font voyager sans aucune limite.

Nous comptons actuellement sur une équipe de plus de 500 personnes qui fabriquent 1.100 modèles différents de couteaux dans une moyenne de 75.000 pièces par jour. C'est sur une superficie de plus de 30 000 m², divisée en plusieurs lieux et située dans la province d'Albacete en Espagne



que se développe cette industrie.

Nous travaillons avec la dernière technologie de fabrication actualisée constamment, an que le niveau de qualité de chaque produit soit toujours pour optimum. Ce qui nous assure la consolidation de notre entreprise comme leader, tant pour le monde professionnel que domestique

ARCOS Hermanos possiede una superficie di lavoro distribuita in varie installazioni nella provincia di Albacete (Spagna). Possiamo dire che la nostra impresa non ha frontiere, giacché possiamo trovare i nostri prodotti in tutti i continenti. ARCOS Hermanos è presente in 94 Paesi e distribuisce i suoi prodotti in tutto il mondo e ciò ci rende la ditta leader di coltelleria, sia di uso professionale come domestico, il cui nome è noto dappertutto. Vogliamo lasciare il nostro segno, e il successo e la qualità dei nostri prodotti ci fa viaggiare oltre tutti i confini.

Fabbricanti di coltelleria da più di 270 anni, attualmente la nostra Azienda può contare su un capitale umano di 500 persone., che attendono alla produzione di 1.100 modelli diversi di coltelli, ad una media di 75.000 pezzi al giorno. La super cie totale coperta delle varie divisioni produttive, in provincia di Albacete , si aggira sui 30.000mq coperti.

Lavoriamo avvalendoci delle ultimissime tecnologie di fabbricazione, aggiornate costantemente, per ottenere una uniformità assoluta di qualità per ciascun prodotto. Siamo inoltre consolidati e riconosciuti come la Impresa Leader sia nella produzione di coltelleria per uso professionale che casalingo.

ARCOS Hermanos tem uma superfície de trabalho dividida em diferentes plantas na província de Albacete (Espanha). Poderíamos dizer que a nossa empresa não tem fronteiras, uma vez que podemos encontrar os nossos produtos em qualquer dos continentes. Operando em 94 países, a ARCOS Hermanos distribui as suas peças por todo o mundo, o que nos torna a principal empresa de cutelaria, tanto profissional como doméstica, cujo nome é conhecido em todo o mundo. Queremos deixar a nossa marca e o sucesso e qualidade dos nossos produtos fazem-nos viajar sem limites.

Atualmente, conta com uma equipa de cerca de 500 pessoas, que fabricam 1.100 modelos diferentes de facas e uma média de 75.000 peças por dia. Esta indústria está localizada numa área de mais de 30.000 m2, dividida em diferentes fábricas na província de Albacete (Espanha).

Trabalha com a mais recente tecnologia de fabrico e atualiza-a constantemente, para que o nível de qualidade de cada produto seja sempre ótimo. Assim, consolidou a sua posição como empresa líder em cutelaria, tanto profissional como para uso doméstico.

BASQUE CULINARY CENTER

Es la primera facultad en gastronomía de España y referencia a nivel mundial. Desde su fundación en 2011 imparte el Grado en Gastronomía y Artes Culinarias y desde entonces ha desarrollado numerosos programas formativos de especialización, atrayendo a jóvenes estudiantes de todo el mundo.

Arcos se suma ahora como empresa colaboradora a este proyecto internacional, que cuenta con el apoyo de algunos de los chefs más influyentes del mundo.

The Basque Culinary Center is the first faculty of Gastronomic Sciences in Spain and is a worldwide reference benchmark. Since its founding in 2011, a Bachelor's Degree in Gastronomy and Culinary Art has been offered and subsequently numerous specialisation training programmes have been developed, attracting young students from all over the world. Arcos now joins as a collaborating company in this international project, which has the backing and support of some of the most influential chefs in the world.

Basque Culinary Center est la première faculté de gastronomie en Espagne et une référence dans le monde. Depuis sa fondation en 2011, elle dispense des études donnant droit au Diplôme en Gastronomie et Arts Culinaires et depuis lors, elle a développé de nombreux programmes de formation de spécialisation, attirant des jeunes étudiants venus des quatre coins du monde. Arcos est désormais une entreprise partenaire de ce projet international, bénéficiant du soutien de certains des chefs les plus influents du monde.

Il Basque Culinary Center è la prima facoltà di gastronomia della Spagna e un riferimento a livello mondiale. Da quando è



stato fondato, nel 2011, impartisce i corsi della Laurea breve in Gastronomia ed Arti Culinarie ed ha sviluppato numerosi programmi formativi di specializzazione, attirando giovani studenti provenienti da tutto il mondo. Ora Arcos si somma a questo progetto internazionale come impresa collaboratrice che possiede il supporto di alcuni fra i più influenti chef del mondo.

O Basque Culinary Center é a primeira faculdade de gastronomia em Espanha e uma referência mundial. Desde a sua fundação em 2011, ensina a Licenciatura em Gastronomia e Artes Culinárias e desde então tem desenvolvido numerosos programas de formação de especialização, atraindo jovens estudantes de todo o mundo. A Arcos junta-se agora a este projeto internacional como uma empresa colaboradora, que tem o apoio de alguns dos chefs mais influentes do mundo.

Después de casi 10 años de colaboración continuamos formando parte de la gran familia Euro-Toques España. Organización de cocineros formada por 800 socios y presidida por Andoni Luis Aduriz, uno de los chefs más influyentes de nuestro tiempo, con dos estrellas Michelin en su restaurante Mugaritz.

After almost 10 years of collaboration, we continue being part of the great Euro-Toques España family. An organisation of chefs made up of 800 members and chaired by Andoni Luis Aduriz, one of the most influential chefs of our time, with his two Michelin star restaurant Mugaritz.

Après près de 10 ans de collaboration, nous faisons toujours partie de la grande famille Euro-Toques Espagne. Organisation de cuisiniers constituée de 800 associés et présidée par Andoni Luis Aduriz, l'un des chefs les plus influents de notre ère, doublement étoilé Michelin dans son restaurant Mugaritz.

Dopo quasi 10 anni di collaborazione, continuiamo a far parte della grande famiglia di Euro-Toques España, un'organizzazione di cuochi che conta 800 soci ed è presieduta da Andoni Luis Aduriz, uno degli chef più influenti dei nostri tempi e il cui ristorante Mugaritz possiede due stelle Michelin.

Após quase 10 anos de colaboração, continuamos a fazer parte da grande família Euro-Toques España. Uma organização de chefs composta por 800 membros e presidida por Andoni Luis Aduriz, um dos chefs mais influentes do nosso tempo, com duas estrelas Michelin no seu restaurante Mugaritz.

EURO- TOQUES



TOLEDO 2022



Karlos Arguiñano en su programa de TV "Cocina Abierta" // Karlos Arguiñano on his TV show "Cocina Abierta"

Arcos ha estado presente en las pantallas de todo el mundo, compartiendo momentos inolvidables en numerosas producciones. No solo en los programas de cocina tan reconocidos como Master Chef, si no también participando en películas de cineastas tan internacionales como Pedro Almodóvar. Pero el cocinero que más tiempo ha confiado en Arcos, trabajando con nuestros cuchillos y ahora con nuestro menaje en su programa durante más de 30 años, es el inigualable Karlos Arguiñano.

Arcos has appeared on screens all over the world, sharing unforgettable moments in numerous productions. Not only in the famous cooking shows such as Master Chef, but also by taking part in the international films of filmmakers like Pedro Almodóvar. However the chef who has trusted in Arcos the longest, working with our knives and now using our tableware in his show for more than 30 years, is the unbeatable Karlos Arguiñano.

Arcos a fait sa marque sur les écrans du monde entier, partageant des moments inoubliables dans de nombreuses productions. Non seulement dans des émissions de cuisine aussi reconnues que Master Chef, mais aussi en participant à des films de réalisateurs aussi internationaux que Pedro Almodóvar. Cependant, le chef qui a le plus longtemps fait confiance à Arcos, travaillant avec nos couteaux et maintenant avec notre équipement dans son émission depuis plus de 30 ans, est le légendaire Karlos Arguiñano.

Arcos è apparsa sugli schermi di tutto il mondo, condividendo momenti indimenticabili in svariate produzioni. Non solo in rinomati programmi di cucina, come Master Chef, ma ha partecipato anche a film di cineasti internazionali, come Pedro Almodóvar. Ma il cuoco che più a lungo si è affidato a Arcos, lavorando nel suo programma con i nostri coltelli per più di 30 anni e ora con il nostro servizio, è l'impareggiabile Karlos Arguiñano.

A Arcos tem estado presente nos ecrãs de todo o mundo, partilhando momentos inesquecíveis em inúmeras produções. Não só em programas de cozinha de renome como Master Chef, mas também participando em filmes de cineastas internacionais como Pedro Almodóvar. Mas o chef há mais tempo a confiar na Arcos, trabalhando com as nossas facas e agora com os nossos utensílios de cozinha no seu programa há mais de 30 anos, é o incomparável Karlos Arguiñano.

EN ESCENA

ON STAGE
SUR SCÈNE
IN SCENA
EM CENA



INFORMACIÓN

INFORMATION
INFORMATION
INFORMAZIONI

1 / PUNTA / TIP / POINTE / PUNTA

Extremo puntiagudo del cuchillo / Pointed end of the knife / Extrême pointe du couteau / Punto estremo finale del coltello

2 / HOJA / BLADE / LAME / LAMA

Lámina generalmente de acero, que constituye la parte cortante de un cuchillo / Usually made from a sheet of steel / Lame généralement en acier qui constitue la partie coupante d'un couteau / Lamina generalmente in acciaio, che costituisce la parte tagliente del coltello

3 / FILO / CUTTING EDGE / FIL / FILO

Borde afilado de la hoja del cuchillo. Este filo puede ser: Filo Simple - Filo Doble - Filo Sierra - Filo Alveolos / Sharp edge of the blade of the knife. The edge can be: Single Edge - Double Edge - Serrated edge - Hollow edge / Bord affilé de la lame. Le fil pourra être: simple fil- double fil- fil cranté - fil alvéolé / Parte o bordo affilato della lama del coltello, che può essere: Filo semplice - doppio filo - seghettatura- filo ad alveoli /

4 / RECAZO / BACK / DOS / DORSO

Parte opuesta al filo del cuchillo / The back of the knife / Partie opposée au fil / Parte opposta al filo della lama del coltello

5 / DEFENSA / DEFENSE / LA GARDE / DIFESA

Tope que ofrece mayor seguridad durante el corte / Near the bottom of the bolster. Shields the hand during the cutting process / Le butoir offre une plus grande sécurité durant la coupe / Bordo accanto alla lama che offre maggior sicurezza durante il taglio

6 / VIROLA / BOLSTER / VIROLE / BILANCIATURA

Parte de unión entre la hoja y el mango, con la que se equilibra el cuchillo / The end of the blade that extends into the handle. Balances the knife / Partie de liaison entre la lame et le manche / Parte di unione fra la lama e il manico che serve per equilibrare il coltello

7 / CACHAS / SCALES / COTES / GUANCETTE

Se denominan así las dos partes que forman el mango / Attached to the tang to form the handle / Ce sont les 2 parties qui sont de part et d'autre du manche / Sono così denominate le due parti che unite formano il manico.

8 / REMACHES / RIVETS / RIVETS / RIVETTI

Unen el mango a la espiga completamente / Connects the handle to the tang / Unissent les cotes et la soie complètement / Uniscono completamente il manico alla spiga del coltello .



CONSEJOS

TIPS

CONSEILS

CONSIGLI

CONSELHOS

CONSEJOS DE UTILIZACIÓN Y MANTENIMIENTO

- 01| Lave los cuchillos inmediatamente después de su uso. Evite el contacto prolongado con restos de alimentos.
- 02| Empleé un detergente neutro o poco alcalino
- 03| No use lejía, sosa o detergentes que contengan cloro o cloruros libres pues corroen el acero o comen el brillo original.
- 04| Evite frotar los cuchillos con productos o estropajos abrasivos así como limpiadores metálicos o sintéticos.
- 05| En el lavavajillas coloque los cuchillos con las hojas hacia abajo, en cestos separados del resto de la vajilla y la cubertería, así evitará cualquier roce.
- 06| No deje los cuchillos sumergidos de forma prolongada en agua, sobre todo si se trata de aguas duras o salinas que afectan al metal.
- 07| Seque inmediatamente los cubiertos con paños suaves y absorbentes.
- 08| El secado del lavavajillas, normalmente no es suficiente para evitar la corrosión.
- 09| Termine de secar las piezas después del ciclo de secado con un paño.
- 10| Procure no dejar mucho tiempo la cubertería en el interior del lavaplatos.

TIPS FOR USE AND MAINTENANCE

- 01| Wash knives immediately after use. Avoid prolonged contact with leftover food.
- 02| Use a neutral or slightly alkaline detergent
- 03| Do not use bleach, soda or detergents containing chlorine or chlorides ions because they rust the steel and cause it to lose its shine.
- 04| Avoid rubbing your knives with abrasive products, cloths, and metallic or synthetic cleaners.
- 05| If you use a dishwasher, place your knives in with the blades facing down and in separate containers from the rest of your cutlery to avoid scratching.
- 06| Avoid leaving your knives submerged in water for long periods of time, especially in hard or saline water which can affect metals.
- 07| Dry immediately with soft, absorbent cloth.
- 08| Leaving your knives to dry in the dishwasher is not recommended.
- 09| Dry your cutlery immediately with a soft and absorbent cloth
- 10| Do not to leave your cutlery in the dishwasher for long periods of time.

CONSEILS D'UTILISATION

- 01| Laver les couteaux immédiatement après leur utilisation afin d'éviter un contact prolongé avec des aliments.
- 02| Utiliser un détergeant neutre et peu alcalin.
- 03| Ne pas utiliser de l'eau de javel, de la soude ou des détergents qui contiennent du chlore qui peuvent attaquer l'acier et enlever le brillant original.
- 04| Eviter de frotter les lames avec des pailles de fer.
- 05| Dans le lave vaisselle, disposer les lames de couteaux vers les bas dans le panier et en les séparant des autres couverts afin de ne pas se blesser.
- 06| Ne pas laisser les couteaux tremper longuement dans de l'eau, surtout si ce sont des eaux dures ou salines.
- 07| Sécher immédiatement les couteaux avec des torchons doux et absorbants.
- 08| Le séchage en lave vaisselle, normalement n'est pas suffisant pour éviter la corrosion.
- 09| Finir de sécher les pièces après un cycle de séchage avec un torchon.
- 10| Ne pas laisser les couteaux longtemps à l'intérieur du lave vaisselle.

CONSIGLI PER IL MIGLIOR UTILIZZO E MANTENIMENTO DEL COLTELLO

- 01| Lavate i coltelli immediatamente dopo l'utilizzo e non lasciateli a lungo a contatto con gli alimenti.
- 02| Utilizzate un detersivo non molto aggressivo.
- 03| Non usare detergenti che contengano cloro o cloruri che possono determinare la corrosione e la perdita della lucentezza del coltello.
- 04| Evitate di sfregare i coltelli con altri oggetti inox, come pulitori metallici etc.
- 05| Collocare i coltelli nella lavastoviglie con la punta della lama rivolta verso il basso, ed in un cesto separati dalle altre stoviglie.
- 06| Non lasciare i coltelli a lungo bagnati, soprattutto se si tratta di acqua salina.
- 07| Asciugare il piu' presto possibile i coltelli con un panno.
- 08| L'asciugatura della lavastoviglie normalmente non è sufficiente.
- 09| Ripassate in seguito il coltello con un panno asciutto.
- 10| Abbiate cura di non lasciare i coltelli a lungo nella lavastoviglie.



ARCOS®

Made in Spain

Since 1734

La empresa se reserva el derecho a cualquier modificación / The company reserves the right to any modification
L'entreprise se réserve le droit à toutes modifications / La ditta si riserva di apportare qualsiasi modifica al presente catalogo che venga ritenuta necessaria
A empresa reserva-se o direito a qualquer modificação.



www.arcos.com



Patrocinador Oficial
Official Sponsor



EUROTOQUES

Empresa colaboradora del Basque Culinary Center
Basque Culinary Center collaborating company



ARCOS[®]

Albacete (Spain) Since 1734

ARCOS HERMANOS, S.A.
Avda. Gregorio Arcos, 38
02007 Albacete - España.

Tel. +34 967 210 261
Fax +34 967 241 318
GPS: 39° 01.040'N - 1° 52.883'W

