

2019



INDUSTRIA 90



INDUSTRIA 90

Fabricación y diseño

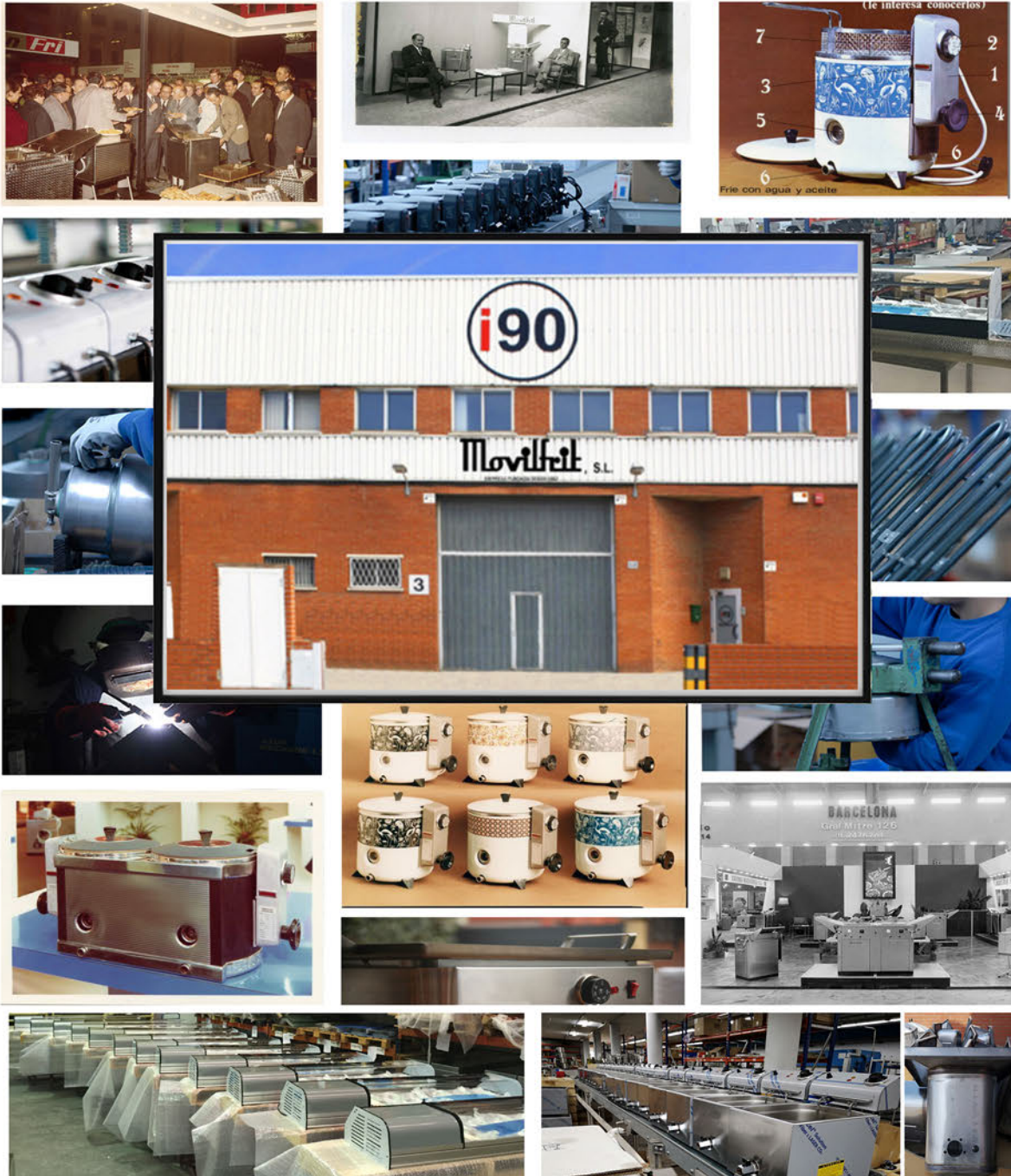

INDUSTRIA 90 pertenece a una empresa familiar que nace en el sector de la fabricación y comercialización de maquinaria para la hostelería desde 1962.

Compromiso, seriedad y confianza son los valores de nuestra marca. Desde siempre, en nuestro centro de desarrollo y montaje ubicado en Sant Boi del Llobregat (Barcelona) diseñamos los mejores productos para ofrecer la mayor calidad garantizada a nuestros clientes.

*De parte de todo el equipo de **INDUSTRIA 90** queremos darles las gracias por su confianza.*

Administrador Único Industria90 S.L.

Administrador Único Movilfrit S.L.
y
Cotitular Marca Movilfrit

Gines Fernández Avellanet

Gines Fernández Avellanet



ORIGINAL
1962
— 100% original —
— PRODUCE IN SPAIN —



EMPRESA COMPANY ENTREPRISE



EMPRESA COMPANY ENTREPRISE

En **INDUSTRIA 90** llevamos más de 50 años en el sector. Somos **auténticos fabricantes** y nuestros reconocidos diseños están fabricados en España por eso verificamos al detalle su calidad . Ya en sus inicios apostó por la fabricación de productos de alta calidad, novedosa tecnología desarrollo y evolución en las últimas tendencias de mercado.

Gracias a nuestra logística garantizamos nuestras **entregas en 24/48h** salida de fábrica una vez realizado el pedido.

Trabajamos con los mejores materiales, cuidamos nuestra imagen y producción. Disponemos de una **atención al cliente** de calidad , personalizada e ininterrumpida .

PERSONALIZAMOS todos nuestros productos **GRATUITAMENTE** con el logo que desee el cliente sin demoras y sin importar las unidades a personalizar.

Contamos con una **amplia red de delegados** por todo el territorio nacional e internacional y un reconocido **servicio técnico** eficaz y eficiente.

INDUSTRIA 90 contribuye a la sostenibilidad y **respeto con el medio ambiente**, es por eso que tiene un gran interés en el uso adecuado de los residuos , el reciclaje y reutilización de los materiales y la buena gestión de consumo de recursos naturales .



+ 50 AÑOS EXPERIENCIA
+ 50 YEARS OF EXPERIENCE
+ 50 ANS D'EXPERIENCE



AUTÉNTICOS FABRICANTES
AUTHENTIC MANUFACTURERS
FABRICANTS AUTHENTIQUES



ENTREGAS EN 24/48H
DELIVERIES IN 24/48H
LIVRAISONS EN 24/48H



ATENCIÓN AL CLIENTE
CUSTOMER SUPPORT
ATTENTION AU CLIENT



RED DELEGADOS COMERCIALES
NETWORK OF COMMERCIAL DELEGATES
RÉSEAU DE DÉLÉGUÉS COMMERCIAUX



SERVICIO TÉCNICO
TECHNICAL SERVICE
SERVICE TECHNIQUE



CONFIANZA Y SERIEDAD
CONFIDENCE AND SERIOUSNESS
CONFIANCE ET SERIEUSE



PERSONALIZA TU PEDIDO GRATUITAMENTE
CUSTOMIZE YOUR ORDER FREE
PERSONNALISEZ VOTRE DEMANDE GRATUIT



SOSTENIBLE
SUSTAINABLE
DURABLE

Personaliza.

Escoja el logo que quiera. Nosotros lo marcamos.



índice

index

index

FREIDORAS ECONÓMICAS
ECONOMIC FRYERS
FRITEUSES ECONOMIQUE



8

FREIDORAS ACEITE
OIL FRYERS
FRITETTES A L'HUILE



20

FREIDORAS AGUA/ACEITE
WATER/OIL FRYERS
FRITEUSES EAU ET HUILE



34

FREIDORAS A GAS
GAS FRYERS
FRITEUSES À GAZ



40

VITRINAS REFRIGERADAS
REFRIGERATED DISPLAY CASES
VITRINES RÉFRIGÉRÉES



44

VITRINAS CALIENTES
HOT DISPLAY CASES
VITRINES CHAUDES



66

VITRINAS NEUTRAS
NEUTRAL DISPLAY CASES
VITRINES NEUTRES



74

VITRINAS ESPECIALES
SPECIAL DISPLAY CASES
VITRINES SPÉCIALES



80

índice

index

index

PLANCHAS /FRYTOP
GRIDDLES /FRYTOP
PLAQUES /FRYTOP



84

COCINAS
KITCHENS
CUISINES



90

SERIE 550
SERIES 550
SÉRIE 550



94

SERIE 700
SERIES 700
SÉRIE 700



104

TERMOS
THERMOS
THERMOS



110

VARIOS
VARIOUS
DIVERS



114

DOMÉSTICO
DOMESTIC
DOMESTIQUE



118

RECAMBIOS
SPARE PARTS
PIÈCES DÉTACHÉES



128

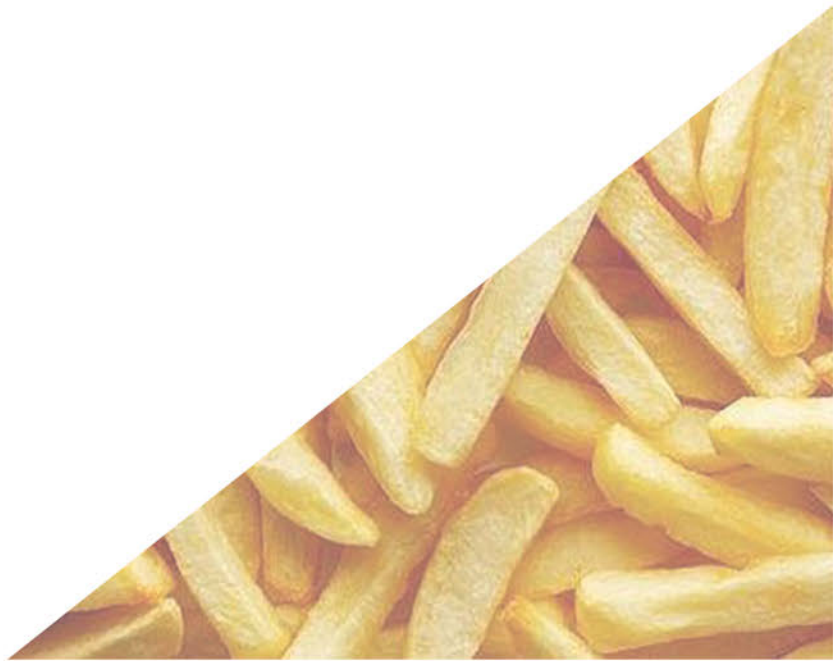

FREIDORAS ECONÓMICAS
ECONOMIC FRYERS
FRITEUSES ECONOMIQUE

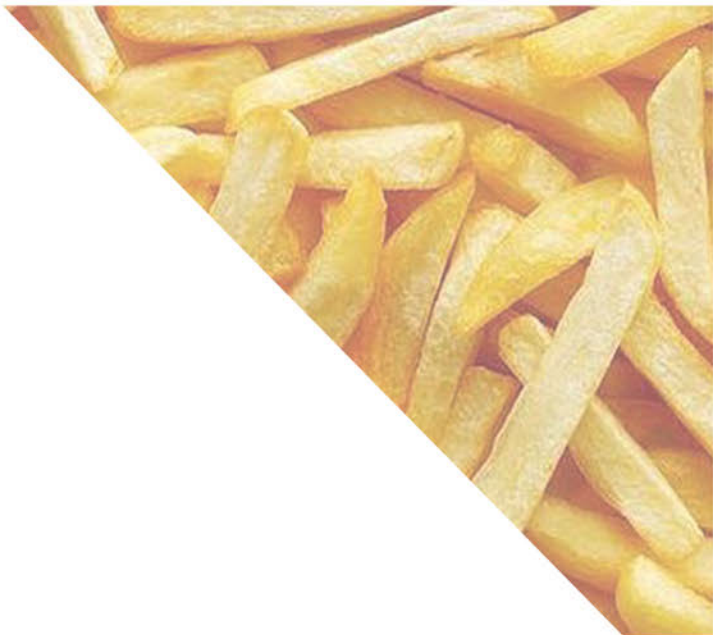

FA



Personaliza



Aceite



Cabezal Fijo



0°C/200°C



Electrica 230/400 V

CARACTERÍSTICAS CHARACTERISTICS CARACTÉRISTIQUES

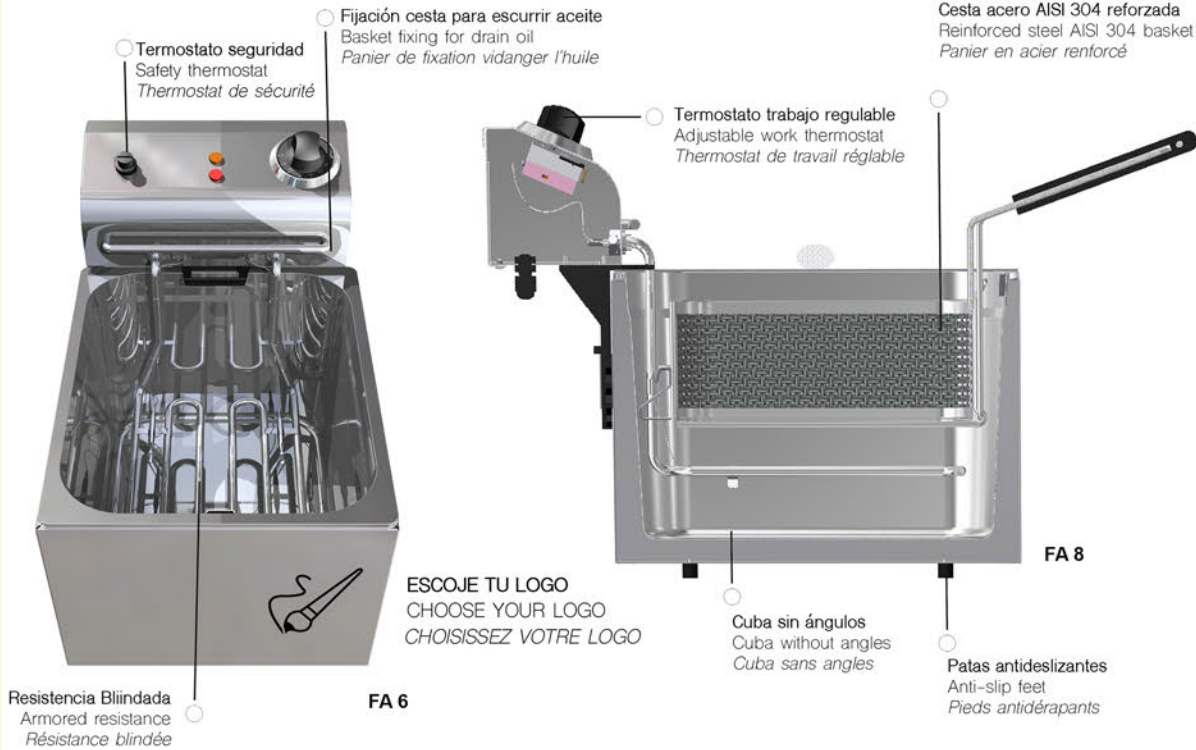

CONSTRUIDA TOTALMENTE EN ACERO INOXIDABLE AISI 304 (18/10)
TOTALLY BUILT IN STAINLESS STEEL AISI 304 (18/10)
TOILEMENT CONSTRUIT EN ACIER INOXYDABLE AISI 304 (18/10)

ACCESORIOS ACCESSORIES ACCESSOIRES



FA

FREIDORAS ECONÓMICAS ACEITE SIN GRIFO
OIL ECONOMIC FRYERS WITHOUT TAP
FRITEUSES D'HUILE ÉCONOMIQUES SANS TAP



INDUSTRIA 90



Modelo	Código	Dimensiones L x P x H (mm)	Potencia Kw	Voltaje V	Capacidad L	Cesta L x P x H (mm)	Raciones 200g	Peso Kg	Precio euros
FA4 S/GRIFO	157399	180X425X282	2	230	4	120X240X85	20	4	235
FA6 S/GRIFO	157400	265X420X335	3	230	6	210X235X95	30	6,5	238
FA6+6 S/GRIFO	157401	530X420X335	3+3	230	6+6	210X235X95	60	12	442
FA8 S/GRIFO	157410	265X420X335	4	230	8	210X235X110	45	7	286
FA8+8 S/GRIFO	157411	530X420X335	4+4	230	8+8	210X235X110	90	12	532
FA10 S/GRIFO	157500	265X420X335	4	230	9	210X235X110	50	7,5	286
FA10+10 S/GRIFO	157501	530X420X335	4+4	230	9+9	210X235X110	100	13	532
FA10 MAX 230 S/GRIFO	157502	265X430X335	6	230	9	210X235X110	75	10	635
FA10+10 MAX 230 S/GRIFO	157503	530X430X335	6+6	230	9+9	210X235X110	150	20	1202
FA10 MAX 400 S/GRIFO	157504	265X430X335	6	400	9	210X235X110	75	10	680
FA10+10 MAX 400 S/GRIFO	157505	530X430X335	6+6	400	9+9	210X235X110	150	20	1291

FA



Personaliza



Aceite



Cabezal Fijo



0°C/200°C



Electrica 230/400 V



CARACTERÍSTICAS CHARACTERISTICS CARACTÉRISTIQUES

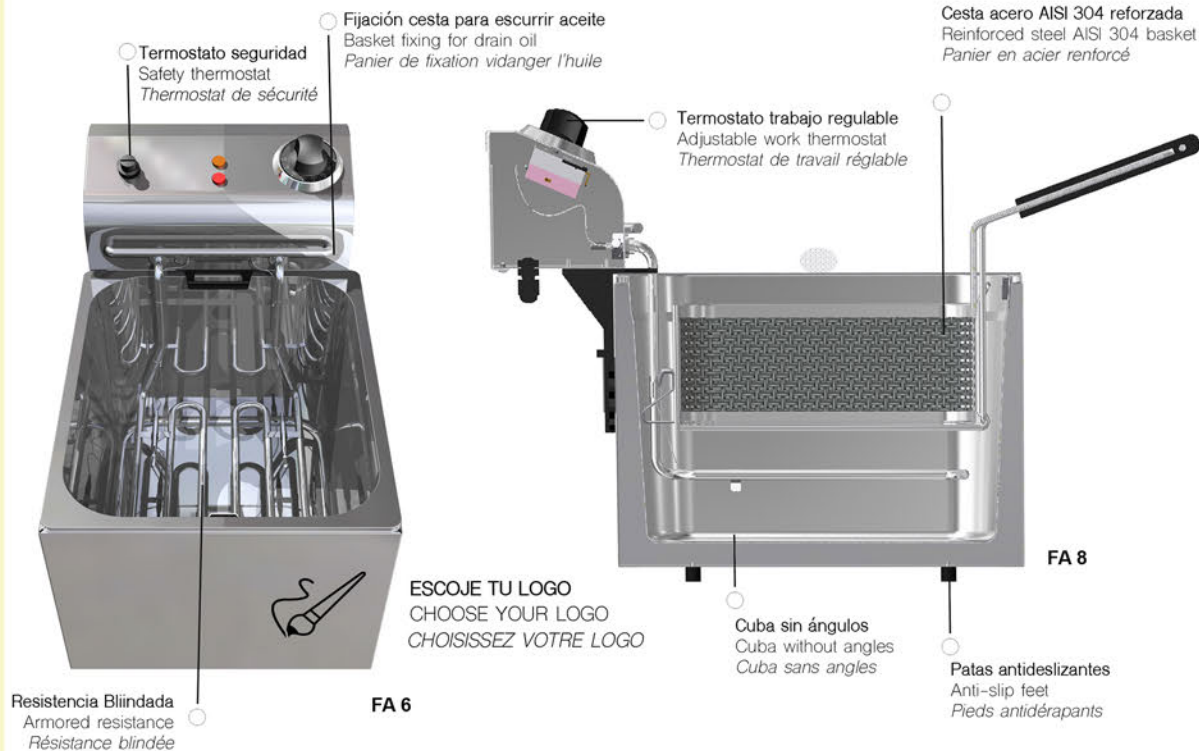

CONSTRUIDA TOTALMENTE EN ACERO INOXIDABLE AISI 304 (18/10)
TOTALLY BUILT IN STAINLESS STEEL AISI 304 (18/10)
TOILEMENT CONSTRUIT EN ACIER INOXYDABLE AISI 304 (18/10)

ACCESORIOS ACCESSORIES ACCESSOIRES



FA



FREIDORAS ECONÓMICAS ACEITE CON GRIFO
OIL ECONOMIC FRYERS WITH TAP
FRITEUSES D'HUILE ÉCONOMIQUES AVEC TAP

i90

INDUSTRIA 90



Modelo	Código	Dimensiones L x P x H (mm)	Potencia Kw	Voltaje V	Capacidad L	Cesta L x P x H (mm)	Raciones 200g	Peso Kg	Precio euros
FA8 C/GRIFO	157506	265X420X335	4	230	8	210X235X110	45	7	307
FA8+8 C/GRIFO	157507	530X420X335	4+4	230	8+8	210X235X110	90	12	576
FA10 C/GRIFO	157412	265X420X335	4	230	9	210X235X110	50	7,5	307
FA10+10 C/GRIFO	157413	530X420X335	4+4	230	9+9	210X235X110	100	13	576
FA10 MAX 230 C/GRIFO	157414	265X430X335	6	230	9	210X235X110	75	10	675
FA10+10 MAX 230 C/GRIFO	157415	530X430X335	6+6	230	9+9	210X235X110	150	20	1276
FA10 MAX 400 C/GRIFO	157416	265X430X335	6	400	9	210X235X110	75	10	722
FA10+10 MAX 400 C/GRIFO	157417	530X430X335	6+6	400	9+9	210X235X110	150	20	1371

FA DOBLE CONTACTOR



Personaliza Aceite Cabezal Fijo 0°C/200°C Eléctrica 230/400

CARACTERÍSTICAS CHARACTERISTICS CARACTÉRISTIQUES

Cesta acero AISI 304 reforzada
Reinforced steel AISI 304 basket
Panier en acier renforcé



DOBLE CONTACTOR
DOUBLE CONTACTOR
DOUBLE CONTACTEUR

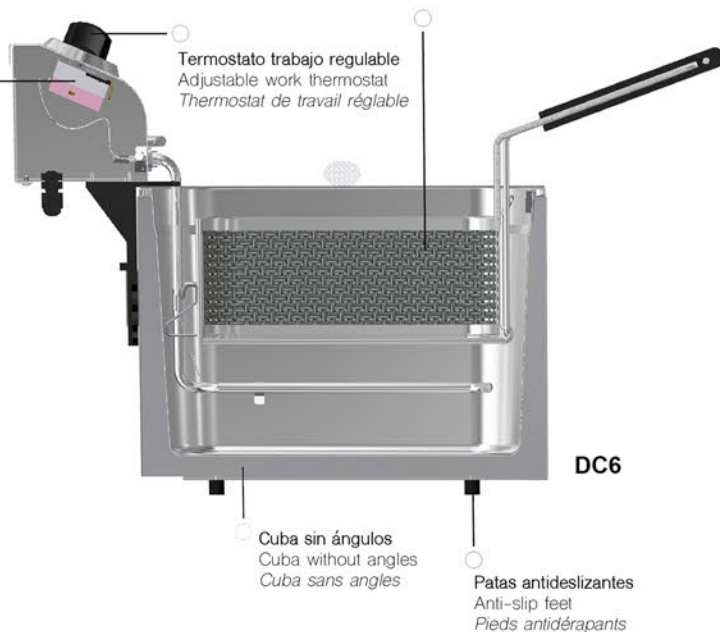

Termostato trabajo regulable
Adjustable work thermostat
Thermostat de travail réglable

DC6

Cuba sin ángulos
Cuba without angles
Cuba sans angles

Patas antideslizantes
Anti-slip feet
Pieds antidérapants

Fijación cesta para escurrir aceite
Basket fixing for drain oil
Panier de fixation vidanger l'huile

Termostato seguridad
Safety thermostat
Thermostat de sécurité

Cabezal eléctrico extraíble fácil limpieza
Removable electric head - easy clean
Tête électrique amovible-nettoyage facile

ACCESORIOS ACCESSORIES ACCESSOIRES



ESCOJE TU LOGO
CHOOSE YOUR LOGO
CHOISISSEZ VOTRE LOGO

Resistencia Bliindada
Armored resistance
Résistance blindée

DC8

FA DOBLE CONTACTOR



FREIDORAS ECONÓMICAS ACEITE SIN GRIFO

OIL ECONOMIC FRYERS WITHOUT TAP

FRITEUSES D'HUILE ÉCONOMIQUES SANS TAP



DC10+10

DC8

Modelo	Código	Dimensiones	Potencia	Voltaje	Capacidad	Cesta	Raciones	Peso	Precio
		L x P x H (mm)	Kw	V	L	L x P x H (mm)	200g	Kg	euros
DOBLE CONTACTOR DC6 S/GRIFO	157380	265X420X335	3	230	6	210X235X95	30	6,5	370
DOBLE CONTACTOR DC6+6 S/GRIFO	157381	530X420X335	3+3	230	6+6	210X235X95	60	12	690
DOBLE CONTACTOR DC8 S/GRIFO	157382	265X420X335	4	230	8	210X235X110	45	7	355
DOBLE CONTACTOR DC8+8 S/GRIFO	157383	530X420X335	4+4	230	8+8	210X235X110	90	12	669
DOBLE CONTACTOR DC-10 S/GRIFO	157386	265X420X335	4	230	9	210X235X110	50	7,5	355
DOBLE CONTACTOR DC-10+10 S/GRIFO	157387	530X420X335	4+4	230	9+9	210X235X110	100	13	669

FA DOBLE CONTACTOR

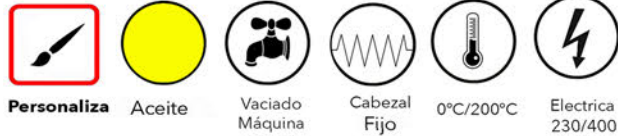

CARACTERÍSTICAS CHARACTERISTICS CARACTÉRISTIQUES

Termostato seguridad
Safety thermostat
Thermostat de sécurité

Termostato trabajo regulable
Adjustable work thermostat
Thermostat de travail réglable

Resistencia Blindada
Armored resistance

Cesta acero AISI 304 reforzada
Reinforced steel AISI 304 basket
Panier en acier renforcé



Cuba sin ángulos
Cuba without angles
Cuba sans angles



DOBLE CONTACTOR
DOUBLE CONTACTOR
DOUBLE CONTACTEUR

FA 10+10 C/GRIFO

ESCOJE TU LOGO
CHOOSE YOUR LOGO
CHOISISSEZ VOTRE LOGO

Grifo incorporado para evacuar aceite
Built-in tap to evacuate oil
Robinet intégré pour évacuer l'huile

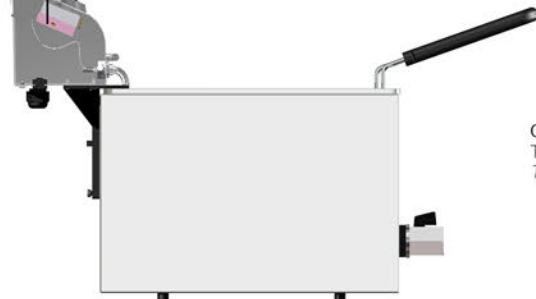

FA 10 C/GRIFO

Patas antideslizantes
Anti-slip feet
Pieds antidérapants

CONSTRUIDA TOTALMENTE EN ACERO INOXIDABLE AISI 304 (18/10)
TOTALLY BUILT IN STAINLESS STEEL AISI 304 (18/10)
TOTALEMENT CONSTRUIT EN ACIER INOXYDABLE AISI 304 (18/10)

Cabezal eléctrico extraíble fácil limpieza
Removable electric head - easy clean
Tête électrique amovible-nettoyage facile



FA 8 C/GRIFO

ACCESORIOS ACCESSORIES ACCESSOIRES



CONTROLADOR TIEMPO FRITURA
CHECK FRIT TIME
CONTRÔLEUR DE TEMPS DE FRITURE



MEDIDOR CALIDAD ACEITE
OIL QUALITY METER
COMPTEUR DE QUALITE D'HUILE

FA DOBLE CONTACTOR



FREIDORAS ECONÓMICAS ACEITE CON GRIFO
OIL ECONOMIC FRYERS WITH TAP
FRITEUSES D'HUILE ÉCONOMIQUES AVEC TAP



DC10

DC10+10

Modelo	Código	Dimensiones L x P x H (mm)	Potencia Kw	Voltaje V	Capacidad L	Cesta L x P x H (mm)	Raciones 200g	Peso Kg	Precio euros
DOBLE CONTACTOR DC8 C/GRIFO	157388	265X420X335	4	230	8	210X235X110	45	7	400
DOBLE CONTACTOR DC8+8 C/GRIFO	157389	530X420X335	4+4	230	8+8	210X235X110	90	12	770
DOBLE CONTACTOR DC-10 C/GRIFO	157384	265X420X335	4	230	9	210X235X110	50	7,5	400
DOBLE CONTACTOR DC-10+10 C/GRIFO	157385	530X420X335	4+4	230	9+9	210X235X110	100	13	770

NEW

FA 20

-  Personaliza
-  Aceite
-  Vaciado Máquina
-  Cabezal Fijo
-  0°C/200°C
-  Eléctrica 230/400 V

CARACTERÍSTICAS CHARACTERISTICS CARACTÉRISTIQUES

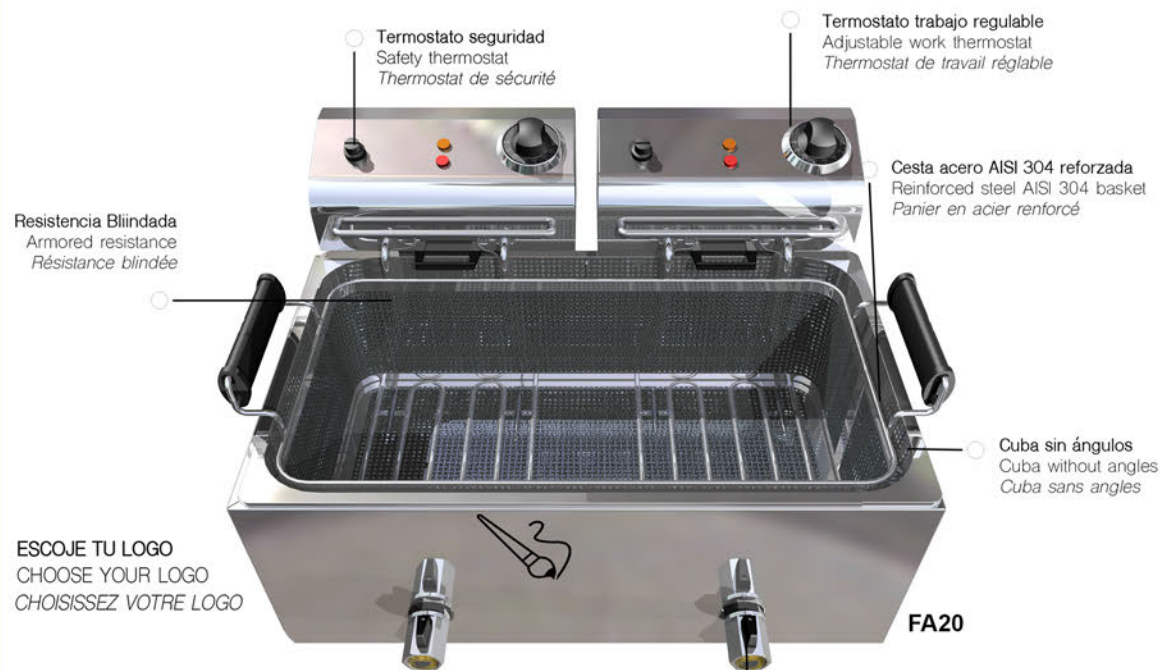

Termostato seguridad
Safety thermostat
Thermostat de sécurité

Termostato trabajo regulable
Adjustable work thermostat
Thermostat de travail réglable

Resistencia Blindada
Armored resistance
Résistance blindée

Cesta acero AISI 304 reforzada
Reinforced steel AISI 304 basket
Panier en acier renforcé

ESCOJE TU LOGO
CHOOSE YOUR LOGO
CHOISISSEZ VOTRE LOGO

Cuba sin ángulos
Cuba without angles
Cuba sans angles

FA20

Grifo incorporado para evacuar aceite
Built-in tap to evacuate oil
Robinet intégré pour évacuer l'huile

CONSTRUIDA TOTALMENTE EN ACERO INOXIDABLE AISI 304 (18/10)
TOTALLY BUILT IN STAINLESS STEEL AISI 304 (18/10)
TOTALEMENT CONSTRUIT EN ACIER INOXYDABLE AISI 304 (18/10)



Cabezal eléctrico extraíble fácil limpieza
Removable electric head - easy clean
Tête électrique amovible-nettoyage facile

Patas antideslizantes
Anti-slip feet
Pieds antidérapants

FA20

ACCESORIOS ACCESSORIES ACCESSOIRES



NEW

FA 20

FREIDORAS ECONÓMICAS ACEITE CON GRIFO
OIL ECONOMIC FRYERS WITH TAP
FRITEUSES D'HUILE ÉCONOMIQUES AVEC TAP



FA20

Modelo	Código	Dimensiones L x P x H (mm)	Potencia Kw	Voltaje V	Capacidad L	Cesta L x P x H (mm)	Raciones 200g	Peso Kg	Precio euros
FA20 C/GRIFO	157510	530X430X335	4+4	230	9+9	470X250X110	100	14	1460



FREIDORAS ACEITE
OIL FRYERS
FRIETTES A L'HUILE





Personaliza



Aceite

Vaciado
MáquinaCabezal
Fijo

0°C/200°C

Eléctrica
230/400

CARACTERÍSTICAS CHARACTERISTICS CARACTÉRISTIQUES

CABEZAL FRONTAL
FRONTAL HEAD
TÊTE AVANTFijación cesta para escurrir aceite
Basket fixing for drain oil
Panier de fixation vidanger l'huile

FAPA 8

Patas antideslizantes regulables
Anti-slip feet adjustable
Pieds antidérapants réglableCuba sin ángulos
Cuba without angles
Cuba sans anglesCONSTRUIDA TOTALMENTE EN ACERO INOXIDABLE AISI 304 (18/10)
TOTALLY BUILT IN STAINLESS STEEL AISI 304 (18/10)
TOTALLEMENT CONSTRUIT EN ACIER INOXYDABLE AISI 304 (18/10)

FAPA 6

ESCOJE TU LOGO
CHOOSE YOUR LOGO
CHOISISSEZ VOTRE LOGOCesta acero AISI 304 reforzada
Reinforced steel AISI 304 basket
Panier en acier renforcéResistencia Bliindada
Armored resistance
Résistance blindée

FAPA 6

Cabezal eléctrico extraíble fácil limpieza
Removable electric head - easy clean
Tête électrique amovible-nettoyage facile

ACCESORIOS ACCESSORIES ACCESSOIRES



NEW!

CONTROLADOR TIEMPO FRITURA
CHECK FRIT TIME
CONTRÔLEUR DE TEMPS DE FRITTER

NEW!

MEDIDOR CALIDAD ACEITE
OIL QUALITY METER
COMPTEUR DE QUALITE D'HUILEFREIDORA ACEITE CABEZAL FRONTAL
OIL FRYER FRONTAL HEAD
TÊTE FRONTALE À FRITEUSE À L'HUILE

FAPA 8

Modelo	Código	Dimensiones	Potencia	Voltaje	Capacidad	Cesta	Raciones	Peso	Precio
		L x P x H (mm)	Kw	V	L	L x P x H (mm)	200g	Kg	euros
FAPA-6	157511	265X450X360	3	230	6	210X235X95	30	8	506
FAPA-8	157512	265X450X360	4	230	8	210X235X110	45	9	580

FAP



Personaliza



Aceite



Vaciado
Máquina



Cabezal
Fijo



0°C/200°C



Electrica
230/400 V

CARACTERÍSTICAS CHARACTERISTICS CARACTÉRISTIQUES

Termostato trabajo regulable
Adjustable work thermostat
Thermostat de travail réglable

ESCOJE TU LOGO
CHOOSE YOUR LOGO
CHOISISSEZ VOTRE LOGO

ESCOJE TU LOGO
CHOOSE YOUR LOGO
CHOISISSEZ VOTRE LOGO

(mod. 25/35)
POSSIBILIDAD DOBLE CESTA
POSSIBILITY DOUBLE BASKET
POSSIBILITÉ DE DOUBLE PANIER

ACCESORIOS ACCESSORIES ACCESSOIRES



CONSTRUIDA TOTALMENTE EN ACERO INOXIDABLE AISI 304 (18/10)
TOTALLY BUILT IN STAINLESS STEEL AISI 304 (18/10)
TOTALEMENT CONSTRUIT EN ACIER INOXYDABLE AISI 304 (18/10)

Cabezal eléctrico extraíble fácil limpieza
Removable electric head - easy clean
Tête électrique amovible-nettoyage facile

Grifo incorporado para evacuar aceite
Built-in tap to evacuate oil
Robinet intégré pour évacuer l'huile

Cuba sin ángulos
Cuba without angles
Cuba sans angles

Patas antideslizantes
Anti-slip feet
Pieds antidérapants

FAP



INDUSTRIA 90

FREIDORAS ACEITE CABEZAL FIJO OIL FRYERS FIXED HEAD FRITEUSES D'HUILE TÊTE FIXE



FAP 12+12

FAP 10

Modelo	Código	Dimensiones L x P x H (mm)	Potencia Kw	Voltaje V	Capacidad L	Cesta L x P x H (mm)	Raciones 200g	Peso Kg	Precio euros
FAP10	157407	325X510X475	4	230	10	185X245X110	55	14	650
FAP10+10	157409	650X510X475	4+4	230	10+10	185X245X110	110	27	1250
FAHP10 230	157424	325X600X450	6	230	10	185X245X110	91	18	1061
FAHP10+10 230	157425	650X600X450	6+6	230	10+10	185X245X110	182	34	2072
FAHP10 400	157426	325X600X450	6	400	10	185X245X110	91	18	1103
FAHP10+10 400	157427	650X600X400	6+6	400	10+10	185X245X110	182	34	2156
FAP12 230	157430	360X580X360	6	230	12	205X285X120	93	27	1197
FAP12+12 230	157431	786X580X360	6+6	230	12+12	205X285X120	184	51	2344
FAP12 400	157432	360X580X360	7	400	12	205X285X120	93	27	1213
FAP12+12 400	157433	786X580X360	7+7	400	12+12	205X285X120	184	51	2369
FAP17 230	157418	360X645X940	6	230	17	205X285X120	110	18	1384
FAP17+17 230	157419	720X645X940	6+6	230	17+17	205X285X120	220	51	2623
FAP17 400	157420	360X645X940	7	400	17	205X285X120	110	28	1427
FAP17+17 400	157423	720X645X940	7+7	400	17+17	205X285X120	220	51	2713
FAP25	157434	410X645X940	15	400	25	235X325X140	260	38	1755
FAP25+25	157435	820X645X940	15+15	400	25+25	235X325X140	520	71	3460
FAP35	157436	530X645X940	15	400	35	350X325X150	275	44	1992
FAP35+35	157437	1065X645X940	15+15	400	35+35	350X325X150	550	86	3763

FAH



Personaliza

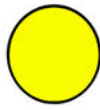

Aceite



Vaciado
Máquina

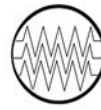

Cabezal
Móvil



0°C/200°C



Electrica
230/400

CARACTERÍSTICAS CHARACTERISTICS CARACTÉRISTIQUES

POSSIBILIDAD DOBLE CESTA
POSSIBILITY DOUBLE BASKET
POSSIBILITÉ DE DOUBLE PANIER
(mod. 25/35)



Termostato seguridad
Safety thermostat
Thermostat de sécurité

Cesta acero AISI 304 reforzada
Reinforced steel AISI 304 basket
Panier en acier renforcé

Cuba sin ángulos
Cuba without angles
Cuba sans angles

ESCOJE TU LOGO
CHOOSE YOUR LOGO
CHOISISSEZ VOTRE LOGO

ESCOJE TU LOGO
CHOOSE YOUR LOGO
CHOISISSEZ VOTRE LOGO

FAH 25+25

FAH 17

Patas regulables antideslizantes
Adjustable anti-slip feet
Pieds antidérapants réglables

CONSTRUIDA TOTALMENTE EN ACERO INOXIDABLE AISI 304 (18/10)
TOTALLY BUILT IN STAINLESS STEEL AISI 304 (18/10)
TOILEMENT CONSTRUIT EN ACIER INOXYDABLE AISI 304 (18/10)

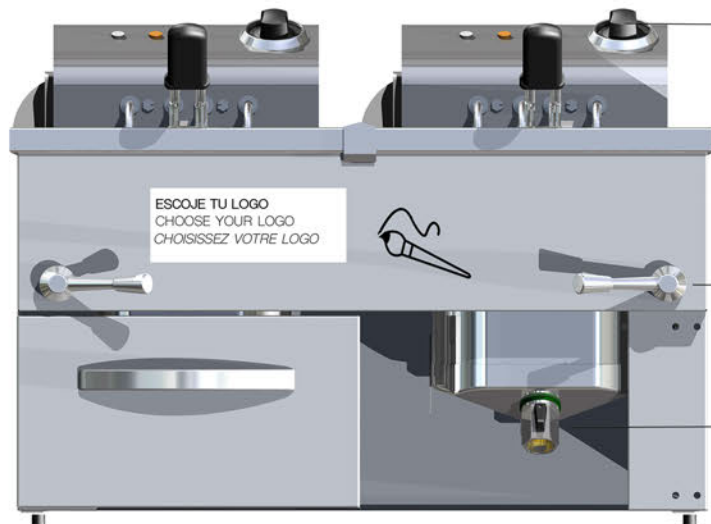

Termostato trabajo regulable
Adjustable work thermostat
Thermostat de travail réglable

ESCOJE TU LOGO
CHOOSE YOUR LOGO
CHOISISSEZ VOTRE LOGO

Sistema elevación
Lifting system
Système de levage

Grifo incorporado para evacuar aceite
Built-in tap to evacuate oil
Robinet intégré pour évacuer l'huile

FAH 10+10

FAH

FREIDORAS ACEITE CABEZAL MÓVIL
OIL FRYERS MOBILE HEAD
FRITEUSES D'HUILE TÊTE MOBILE



INDUSTRIA 90



FAH10+10

FAH10

Modelo	Código	Dimensiones L x P x H (mm)	Potencia Kw	Voltaje V	Capacidad L	Cesta L x P x H (mm)	Raciones 200g	Peso Kg	Precio euros
FAH10 230	157356	325X600X450	6	230	10	185X245X110	91	17	1098
FAH10+10 230	157358	650X600X450	6+6	230	10+10	185X245X110	182	33	2171
FAH10 400	157357	325X600X450	6	400	10	185X245X110	91	17	1142
FAH10+10 400	157359	650X600X450	6+6	400	10+10	185X245X110	182	33	2259
FAH12 230	157340	360X580X450	6	230	12	205X285X120	93	27	1246
FAH12+12 230	157341	720 X580X450	6+6	230	12+12	205X285X120	184	51	2467
FAH12 400	157342	360X580X450	7	400	12	205X285X120	93	27	1297
FAH12+12 400	157343	720 X580X450	7+7	400	12+12	185X245X110	184	51	2569
FAH17 230	157360	360X645X940	6	230	17	185X245X110	110	27	1434
FAH17+17 230	157362	720 X645X940	6+6	230	17+17	185X245X110	220	51	2772
FAH17 400	157361	360X645X940	7	400	17	185X245X110	110	27	1476
FAH17+17 400	157363	720 X645X940	7+7	400	17+17	185X245X110	220	51	2861
FAH25	157365	410X645X940	15	400	25	235X325X140	260	37	1815
FAH25+25	157367	820X645X940	15+15	400	25+25	235X325X140	520	69	3598
FAH35	157368	530X645X940	15	400	35	350X325X150	275	41	2060
FAH35+35	157370	1065X645X940	15+15	400	35+35	350X325X150	550	86	3981

FAR



Personaliza

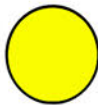

Aceite



Vaciado
Máquina

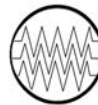

Cabezal
Móvil



0°C/200°C



Electrica
230/400

CARACTERÍSTICAS CHARACTERISTICS CARACTÉRISTIQUES



POSSIBILIDAD DOBLE CESTA
POSSIBILITY DOUBLE BASKET
POSSIBILITÉ DE DOUBLE PANIER
(mod. 25/35)

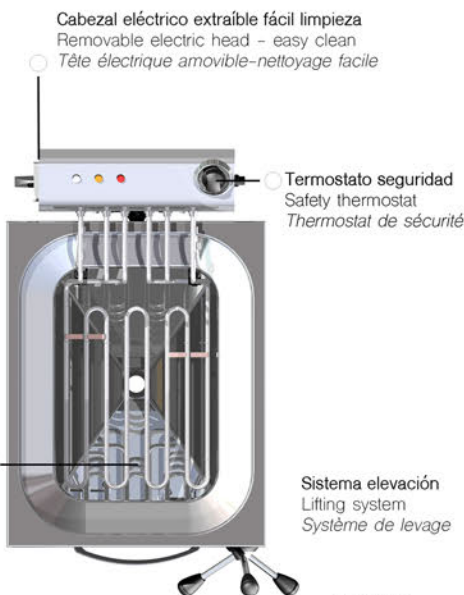

Cabezal eléctrico extraíble fácil limpieza
Removable electric head - easy clean
Tête électrique amovible-nettoyage facile

Termostato seguridad
Safety thermostat
Thermostat de sécurité

Resistencia Bliindada
Armored resistance
Résistance blindée

Sistema elevación
Lifting system
Système de levage

FAR 25

Termostato trabajo regulable
Adjustable work thermostat
Thermostat de travail réglable

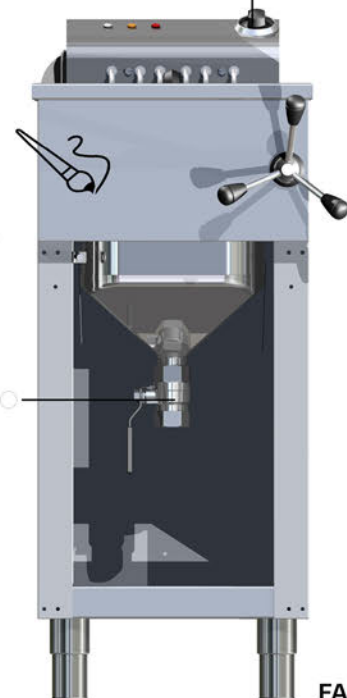

ESCOJE TU LOGO
CHOOSE YOUR LOGO
CHOISISSEZ VOTRE LOGO

Grifo incorporado para evacuar aceite
Built-in tap to evacuate oil
Robinet intégré pour évacuer l'huile

Patas antideslizantes
Anti-slip feet
Pieds antidérapants

FAR 25

ACCESORIOS ACCESSORIES ACCESSOIRES



NEW!

CONTROLADOR TIEMPO FRITURA
CHECK FRIT TIME
CONTRÔLEUR DE TEMPS DE FRITTER



NEW!

MEDIDOR CALIDAD ACEITE
OIL QUALITY METER
COMPTEUR DE QUALITE D'HUILE

FAR

FREIDORAS ACEITE ALTO RENDIMIENTO
OIL FRYERS HIGH PERFORMANCE
FRITEUSES D'HUILE HAUT RENDEMENT



INDUSTRIA 90



FAR 17



FAR 10

Modelo	Código	Dimensiones	Potencia	Voltaje	Capacidad	Cesta	Raciones	Peso	Precio
		L x P x H (mm)	Kw	V	L	L x P x H (mm)	200g	Kg	euros
FAR10	157320	325X600X450	10	400	10	185X245X110	160	17	1535
FAR10+10	157319	650x600x450	10+10	400	10+10	185X245X110	320	33	2872
FAR17	157321	360X645X940	17	400	17	205X285X120	220	27	1954
FAR17+17	157322	780x645x940	17+17	400	17+17	205X285X120	440	51	3655
FAR25	157324	410X645X940	25	400	25	235X325X140	35	37	2613
FAR25+25	157325	820x645x940	25+25	400	25+25	235X325X140	700	69	5047

NEW

FARP



Personaliza



Aceite



Vaciado
Máquina



Cabezal
Móvil



0°C/200°C



Eléctrica
230/400

CARACTERÍSTICAS CHARACTERISTICS CARACTÉRISTIQUES

Cesta acero AISI 304 reforzada
Reinforced steel AISI 304 basket
Panier en acier renforcé



POSSIBILIDAD DOBLE CESTA
POSSIBILITY DOUBLE BASKET
POSSIBILITÉ DE DOUBLE PANIER
(mod. 25/35)



FARP 25+25

CONSTRUIDA TOTALMENTE EN ACERO INOXIDABLE AISI 304 (18/10)
TOTALLY BUILT IN STAINLESS STEEL AISI 304 (18/10)
TOILEMENT CONSTRUIT EN ACIER INOXYDABLE AISI 304 (18/10)



FARP 25

ESCOJE TU LOGO
CHOOSE YOUR LOGO
CHOISISSEZ VOTRE LOGO

Patas antideslizantes
Anti-slip feet
Pieds antidérapants

Termostato trabajo regulable
Adjustable work thermostat
Thermostat de travail réglable

Resistencia Bliindada
Armored resistance
Résistance blindée

Cabezal eléctrico extraíble fácil limpieza
Removable electric head - easy clean
Tête électrique amovible-nettoyage facile

ACCESORIOS ACCESSORIES ACCESSOIRES



CONTROLADOR TIEMPO FRITURA
CHECK FRIT TIME
CONTRÔLEUR DE TEMPS DE FRITTER



MEDIDOR CALIDAD ACEITE
OIL QUALITY METER
COMPTEUR DE QUALITE D'HUILE

NEW

FARP

FREIDORA ALTO RENDIMIENTO SIN ELEVACIÓN
HIGH PERFORMANCE FRYER WITHOUT ELEVATION
FRITEUSE HAUTE PERFORMANCE SANS ELEVATION



INDUSTRIA 90



FARP 10



FARP 17

Modelo	Código	Dimensiones L x P x H (mm)	Potencia Kw	Voltaje V	Capacidad L	Cesta L x P x H (mm)	Raciones		Precio
							200g	Kg	
FARP10	157326	325X600X450	10	400	10	185X245X110	160	17	1484
FARP10+10	157327	650x600x450	10+10	400	10+10	185X245X110	320	33	2776
FARP17	157328	360X645X940	17	400	17	205X285X120	220	27	1889
FARP17+17	157329	780x645x940	17+17	400	1717	205X285X120	440	51	3533
FARP25	157330	410X645X940	25	400	25	235X325X140	35	37	2525
FARP25+25	157331	820x645x940	25+25	400	25+25	235X325X140	700	69	4878

NEW

iFAP



Digital

Personaliza

Aceite

Vaciado
Máquina

Cabezal
Fijo

0°C/200°C

Electrica
230/400

CARACTERÍSTICAS CHARACTERISTICS CARACTÉRISTIQUES



Tapa antisplacaduras
Splash cap
Casquette Splash

Cabezal eléctrico extraíble fácil limpieza
Cabezal eléctrico extraíble - easy clean
Tête électrique amovible-nettoyage facile

iFAP

Patas antideslizantes
Anti-slip feet
Pieds antidérapants



CON PANTALLA TÁCTIL PROGRAMADA
WITH PROGRAMMED TACTILE SCREEN
AVEC ÉCRAN TACTILE PROGRAMMÉ

NEW!



CON PANTALLA TÁCTIL PROGRAMADA
WITH PROGRAMMED TACTILE SCREEN
AVEC ÉCRAN TACTILE PROGRAMMÉ



Termostato seguridad
Safety thermostat
Thermostat de sécurité

ON/OFF

Termostato trabajo regulable
Adjustable work thermostat
Thermostat de travail réglable

Cuba sin ángulos
Cuba without angles
Cuba sans angles

NEW!

iFAP

ACCESORIOS ACCESSORIES ACCESSOIRES



NEW!

CONTROLADOR TIEMPO FRITURA
CHECK FRIT TIME
CONTRÔLEUR DE TEMPS DE FRITTER

ESCOJE TU LOGO
CHOOSE YOUR LOGO
CHOISISSEZ VOTRE LOGO



NEW!

MEDIDOR CALIDAD ACEITE
OIL QUALITY METER
COMPTEUR DE QUALITE D'HUILE

CONSTRUIDA TOTALMENTE EN ACERO INOXIDABLE AISI 304 (18/10)
TOTALLY BUILT IN STAINLESS STEEL AISI 304 (18/10)
TOTALLEMENT CONSTRUIT EN ACIER INOXYDABLE AISI 304 (18/10)

NEW

iFAP



INDUSTRIA 90

FREIDORA ACEITE DIGITAL
DIGITAL OIL FRYER
FRITEUSE À HUILE NUMÉRIQUE



iFAP

Modelo	Código	Dimensiones L x P x H (mm)	Potencia Kw	Voltaje V	Capacidad			Cesta L x P x H (mm)	Raciones 200g	Peso Kg	Precio euros
					Agua(L)	Aceite(L)	Total(L)				
iFAP17	157518	400X700X940	6	230	4,5	15	19,5	208X285X120	110	30	3723
iFAP17+17	157519	800X700X940	6+6	230	4,5+4,5	15+15	19,5+19,5	208X285X120	220	55	6966

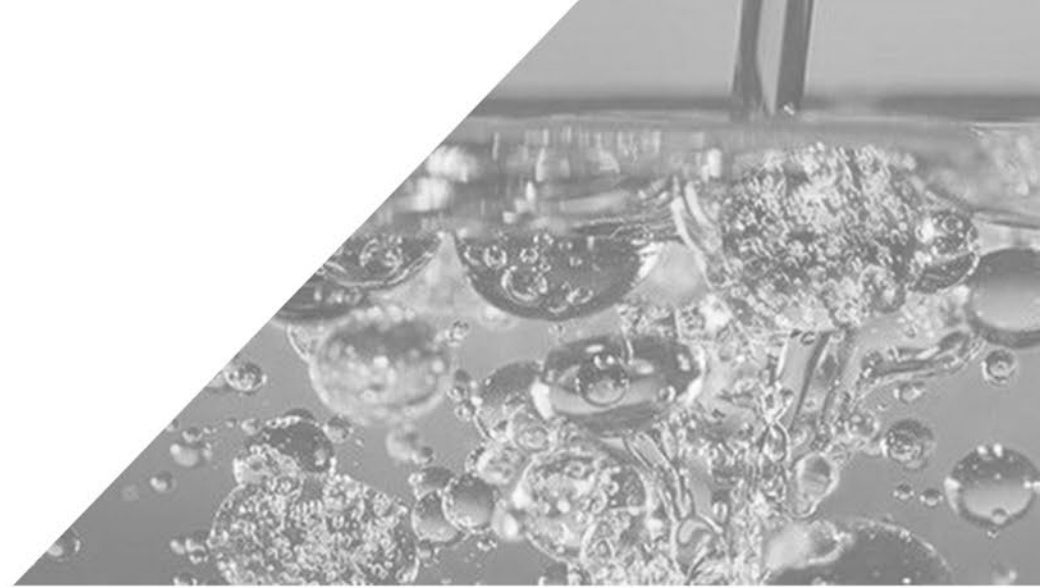

FREIDORAS AGUA - ACEITE
WATER / OIL FRYERS
FRIETTES EAU ET HUILE

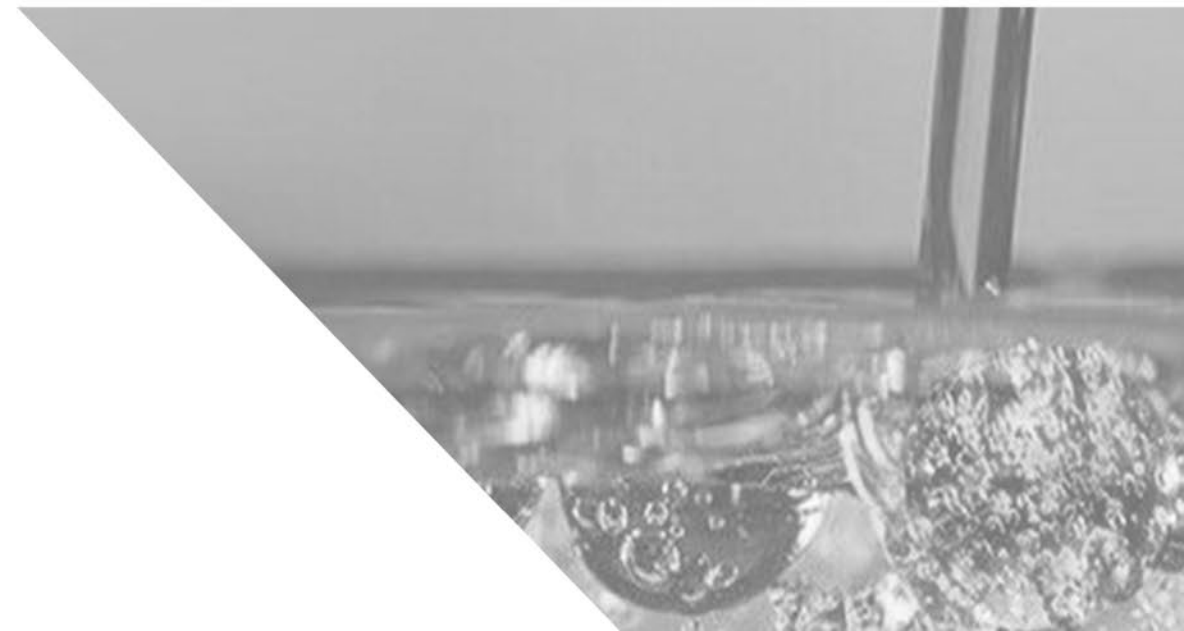

F



Personaliza



Agua/Aceite



Vaciado
Máquina



Cabezal
Móvil



Visor
Agua/Aceite



0°C/200°C



Eléctrica
230 V

CARACTERÍSTICAS CHARACTERISTICS CARACTÉRISTIQUES

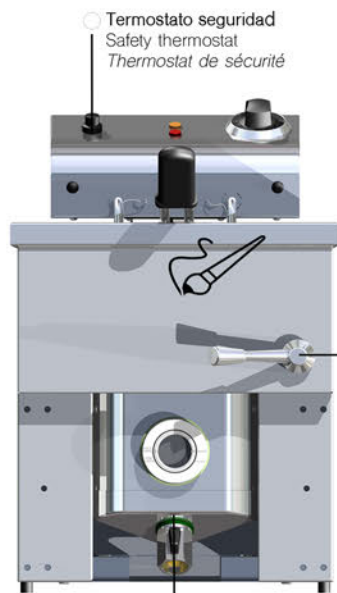

Termostato seguridad
Safety thermostat
Thermostat de sécurité

ESCOJE TU LOGO
CHOOSE YOUR LOGO
CHOISISSEZ VOTRE LOGO

Sistema elevación
Lifting system
Système de levage

F10

Grifo incorporado para evacuar aceite
Built-in tap to evacuate oil
Robinet intégré pour évacuer l'huile



SISTEMA AGUA ACEITE
WATER OIL SYSTEM
SYSTÈME D'EAU ET D'HUILE

- Mayor duración del aceite
- Ahorro de energía
- Permite freír sin mezclar sabores

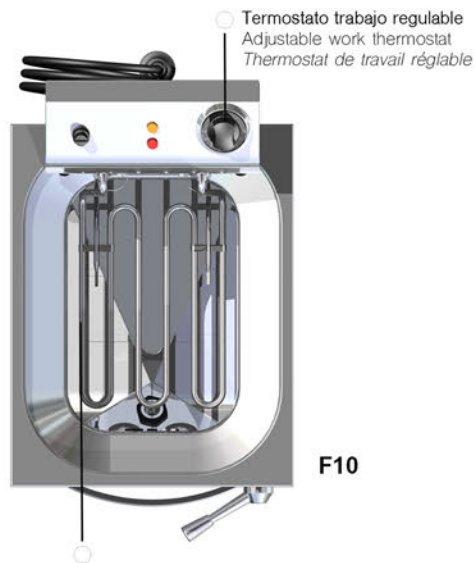

Termostato trabajo regulable
Adjustable work thermostat
Thermostat de travail réglable

F10

Resistencia blindada en acero inoxidable
Armored resistance in stainless steel
Résistance blindée en acier inoxydable

CONSTRUIDA TOTALMENTE EN ACERO INOXIDABLE AISI 304 (18/10)
TOTALLY BUILT IN STAINLESS STEEL AISI 304 (18/10)
TOTALEMENT CONSTRUIT EN ACIER INOXYDABLE AISI 304 (18/10)

Cabezal eléctrico extraíble fácil limpieza
Removable electric head - easy clean
Tête électrique amovible-nettoyage facile

ACCESORIOS ACCESSORIES ACCESSOIRES



NEW!

CONTROLADOR TIEMPO FRITURA
CHECK FRIT TIME
CONTRÔLEUR DE TEMPS DE FRITTER



NEW!

MEDIDOR CALIDAD ACEITE
OIL QUALITY METER
COMPTÉUR DE QUALITÉ D'HUILE



F10+10

Patas antideslizantes
Anti-slip feet
Pieds antidérapants

F



INDUSTRIA 90

FREIDORA AGUA/ACEITE CABEZAL MÓVIL ECONÓMICAS
WATER AND OIL ECONOMIC FRYERS
FRITEUSES ECONOMIQUE EAU ET HUILE



F10

Modelo	Código	Dimensiones	Potencia	Voltaje	Capacidad			Cesta	Raciones	Peso	Precio
		L x P x H (mm)	Kw	V	Agua(L)	Aceite(L)	Total(L)	L x P x H (mm)	200g	Kg	euros
F10	107066	325X510X475	4	230	3,5	10	13,5	185X245X110	55	14	789
F10+10	107067	650X510X475	4+4	230	3,5+3,5	10+10	13,5+13,5	185X245X110	110	27	1568



Personaliza



Vaciado Agua



Agua/Aceite



Vaciado Máquina



Cabezal Móvil



Visor Agua/Aceite



0°C/200°C



Electrica 230/400 V

CARACTERÍSTICAS CHARACTERISTICS CARACTÉRISTIQUES

CONSTRUIDA TOTALMENTE EN ACERO INOXIDABLE AISI 304 (18/10)
TOTALLY BUILT IN STAINLESS STEEL AISI 304 (18/10)
TOILEMENT CONSTRUIT EN ACIER INOXYDABLE AISI 304 (18/10)



FH10+10

Termostato trabajo regulable
Adjustable work thermostat
Thermostat de travail réglable

Cabezal eléctrico extraíble fácil limpieza
Removable electric head - easy clean
Tête électrique amovible-nettoyage facile

Termostato seguridad
Safety thermostat
Thermostat de sécurité

Grifo incorporado para evacuar aceite
Built-in tap to evacuate oil
Robinet intégré pour évacuer l'huile



SISTEMA AGUA ACEITE
WATER OIL SYSTEM
SYSTÈME D'EAU ET D'HUILE

- Mayor duración del aceite
- Ahorro de energía
- Permite freír sin mezclar sabores

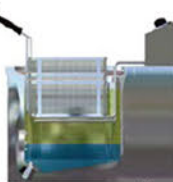

POSSIBILIDAD DOBLE CESTA
POSSIBILITY DOUBLE BASKET
POSSIBILITÉ DE DOUBLE PANIER
(mod. 25/35)



FH35+35

Patas antideslizantes
Anti-slip feet
Pieds antidérapants

ACCESORIOS ACCESSORIES ACCESSOIRES



CONTROLADOR TIEMPO FRITURA
CHECK FRIT TIME
CONTRÔLEUR DE TEMPS DE FRITTER



MEDIDOR CALIDAD ACEITE
OIL QUALITY METER
COMPTEUR DE QUALITE D'HUILE

FREIDORAS AGUA/ACEITE CABEZAL MÓVIL WATER AND OIL FRYERS MOBILE HEAD TÊTE MOBILE DE FRITEUSE A EAU ET HUILE



FH10+10

Modelo	Código	Dimensiones L x P x H (mm)	Potencia Kw	Voltaje V	Capacidad			Cesta L x P x H (mm)	Raciones 200g	Peso Kg	Precio euros
					Agua(L)	Aceite(L)	Total(L)				
FH10 230	107306	325X600X450	6	230	3,5	10	13,5	185x245x110	91	18	1143
FH10+10 230	107308	325X600X450	6+6	230	3,5+3,5	10+10	13,5+13,5	185x245x110	182	34	2236
FH10 400	107307	325X600X450	6	400	3,5	10	13,5	185x245x110	91	18	1191
FH10+10 400	107309	325X600X450	6+6	400	3,5+3,5	10+10	13,5+13,5	185x245x110	182	34	2332
FH17 230	107310	360X645X940	6	230	4,5	15	19,5	205x285x120	110	28	1468
FH17+17 230	107312	360X645X940	6+6	230	4,5+4,5	15+15	19,5+19,5	205x285x120	220	51	2795
FH17 400	107311	360X645X940	7	400	4,5	15	19,5	205x285x120	110	28	1526
FH17+17 400	107313	360X645X940	7+7	400	4,5+4,5	15+15	19,5+19,5	205x285x120	220	51	2895
FH25	107315	410X645X940	15	400	8	23	31	235x325x140	260	38	1989
FH25+25	107317	410X645X940	15+15	400	8+8	23+23	31+31	235x325x140	520	71	3810
FH35	107318	530X645X940	15	400	14	30	44	350x325x150	275	44	2175
FH35+35	107320	530X645X940	15+15	400	14+14	30+30	44+44	350x325x150	550	86	3995



FREIDORAS A GAS
GAS FRYERS
FRITEUSES À GAZ



CARACTERÍSTICAS CHARACTERISTICS CARACTÉRISTIQUES

Cubeta embutida sin soldaduras
Inlaid bucket without welds
Seau incrusté sans soudures

Fabricadas en acero AISI 304 con ángulos redondeados
Made of AISI 304 steel with rounded corners
Fabriqué en acier AISI 304 avec angles arrondis



ESCOJE TU LOGO
CHOOSE YOUR LOGO
CHOISISSEZ VOTRE LOGO

FG10+10



ESCOJE TU LOGO
CHOOSE YOUR LOGO
CHOISISSEZ VOTRE LOGO

Termostado regulación
Thermostat regulation
Réglage du thermostat

Termostato de Seguridad
Safety thermostat
Thermostat de sécurité

FG10

Válvula de gas mecánica con termostato integrado
Mechanical gas valve with integrated thermostat
Robinet à gaz mécanique avec thermostat intégré

Cámara de combustión Ecológica sin materiales aislantes
Ecological combustion chamber without insulating materials
Chambre de combustion écologique sans matériaux isolants



ESCOJE TU LOGO
CHOOSE YOUR LOGO
CHOISISSEZ VOTRE LOGO

Amplia zona fría
Wide cold area
Large zone froide

Termostato de Seguridad
Safety thermostat
Thermostat de sécurité

FG20+20



ESCOJE TU LOGO
CHOOSE YOUR LOGO
CHOISISSEZ VOTRE LOGO

FG20

Gestión electrónica y simplificada con dos temperaturas de funcionamiento regulables
Electronic and simplified management with two adjustable operating temperatures
Gestion électronique et simplifiée avec deux températures de fonctionnement réglables

FREIDORAS GAS GAS FRYERS FRITEUSES À GAZ



FG17

Modelo	Código	Dimensiones	Potencia		Capacidad	Tensión	Cesta	Peso	Precio
			Kw	Kcal/h					
		L x P x H (mm)			L	V	L x P x H (mm)	Kg	euros
FG-10	500000	400X600X698	6,5	7151	10	--	290X215X120	9	1632
FG-10+10	500001	700X600X698	6,5+6,5	1430	10+10	--	290X215X120	18	2697
FG-17	500002	400X700X1139	12	1320	17	--	375X215X120	18	2431
FG-17+17	500003	700X700X1139	12+12	2640	17+17	--	375X215X120	36	4353
FG-20+20	500004	800X700X1110	15+15	3300	20+20	230	260X280X150	44	4769
FG-20	500005	400X700X1110	15	1650	20	230	260X280X150	22	2755

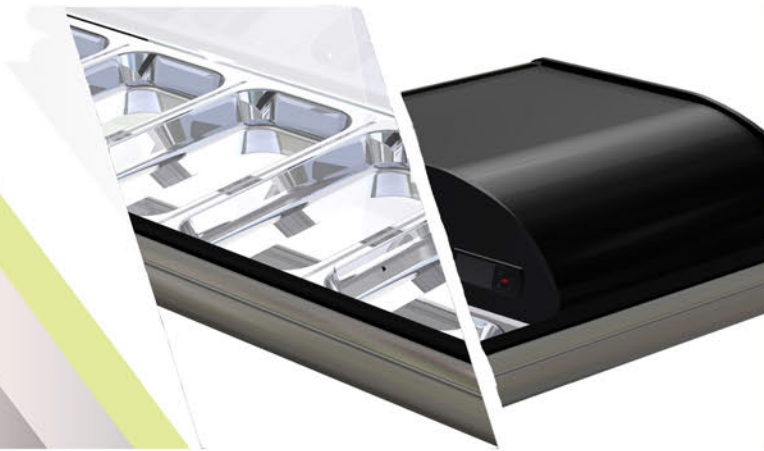

VITRINAS REFRIGERADAS
REFRIGERATED DISPLAY CASES
VITRINES RÉFRIGÉRÉES



IRON



CARACTERÍSTICAS CHARACTERISTICS CARACTÉRISTIQUES

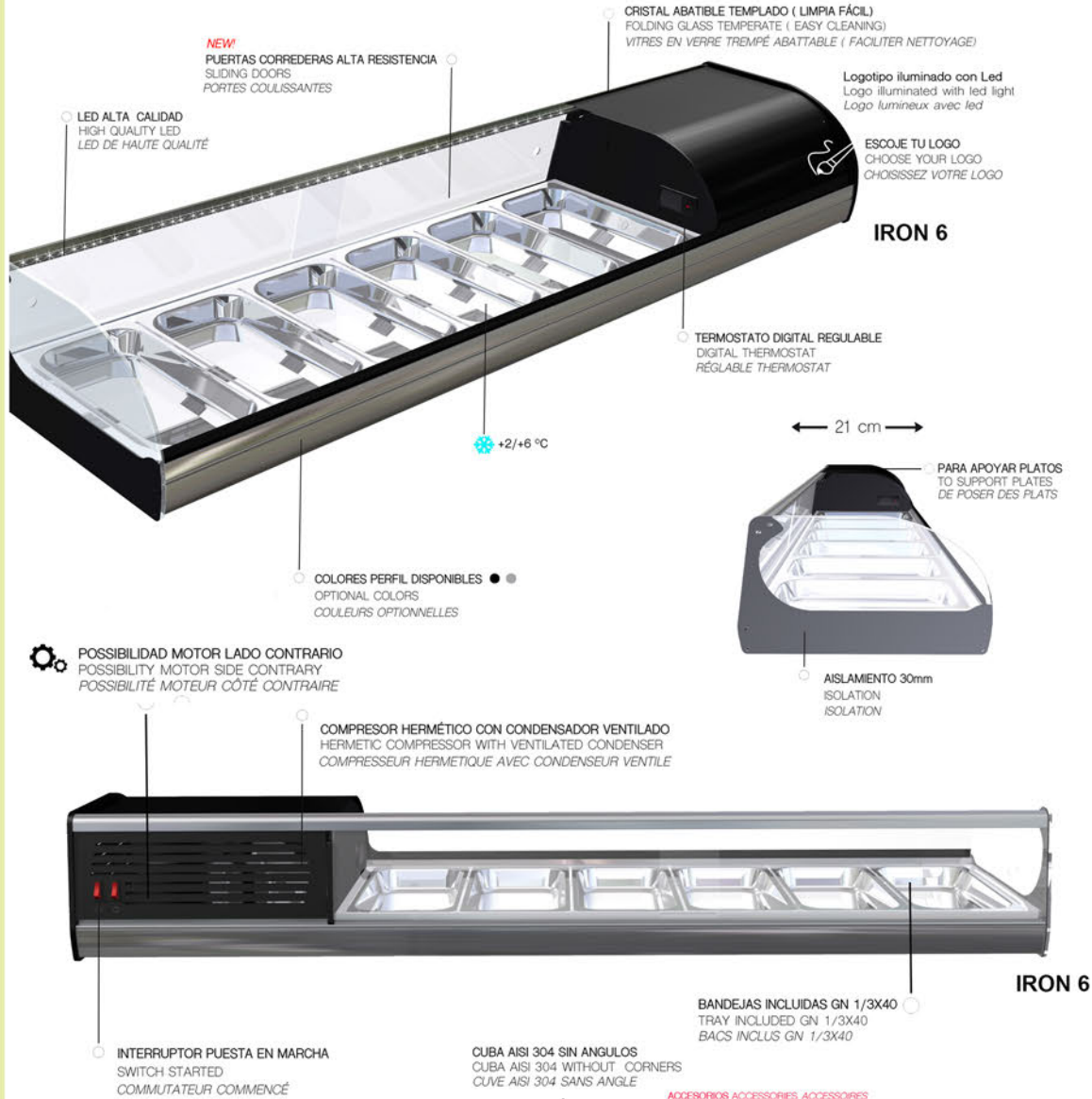

IRON 6

IRON 6



COLORES DISPONIBLES
CHOOSE YOUR COLOUR
COULEURS DISPONIBLES



POSSIBILIDAD CUBA PLANA
POSSIBILITY OF FLAT PLATE
POSSIBILITÉ DE CUVE PLANE (SANS BAC)

IRON



VITRINAS REFRIGERADAS CRISTAL CURVO ABATIBLE REFRIGERATED DISPLAY CASES CURVE CRYSTAL VITRINES RÉFRIGÉRÉES VITRE ABATTABLE COURBÉ



IRON 4 CUBA PLANA



IRON 6

Modelo	Código			Dimensiones L x P x H (mm)	Pot. w	Temp. °C	Tensión V	Capacidad	Peso Kg	Precio euros
	Negra	Blanca	Roja							
IRON 4	877015	877024	877021	1146X390X215	160	+2°C/+6°C	230	4XGN1/3x40	24	759
IRON 6	877016	877025	877022	1487X390X215	160	+2°C/+6°C	230	6XGN1/3x40	34	869
IRON 8	877017	877026	877023	1826X390X215	160	+2°C/+6°C	230	8XGN1/3x40	40	954
IRON REMOTA 6	876909	-	-	1146X390X215	160	+2°C/+6°C	230	6XGN1/3x40	32	990
IRON REMOTA 8	876910	-	-	1487X390X215	160	+2°C/+6°C	230	8XGN1/3x40	35	1088
IRON 4 CUBA PLANA	877033	877039	877036	1146X390X215	160	+2°C/+6°C	230	sin bandejas	24	759
IRON 6 CUBA PLANA	877034	877040	877037	1487X390X215	160	+2°C/+6°C	230	sin bandejas	34	869
IRON 8 CUBA PLANA	877035	877041	877038	1826X390X215	160	+2°C/+6°C	230	sin bandejas	40	954
IRON REMOTA 6 CUBA PLANA	876912	-	-	1146X390X215	160	+2°C/+6°C	230	sin bandejas	32	990
IRON REMOTA 8 CUBA PLANA	876913	-	-	1487X390X215	160	+2°C/+6°C	230	sin bandejas	35	1088

IRON SUSHI



CARACTERÍSTICAS CHARACTERISTICS CARACTÉRISTIQUES

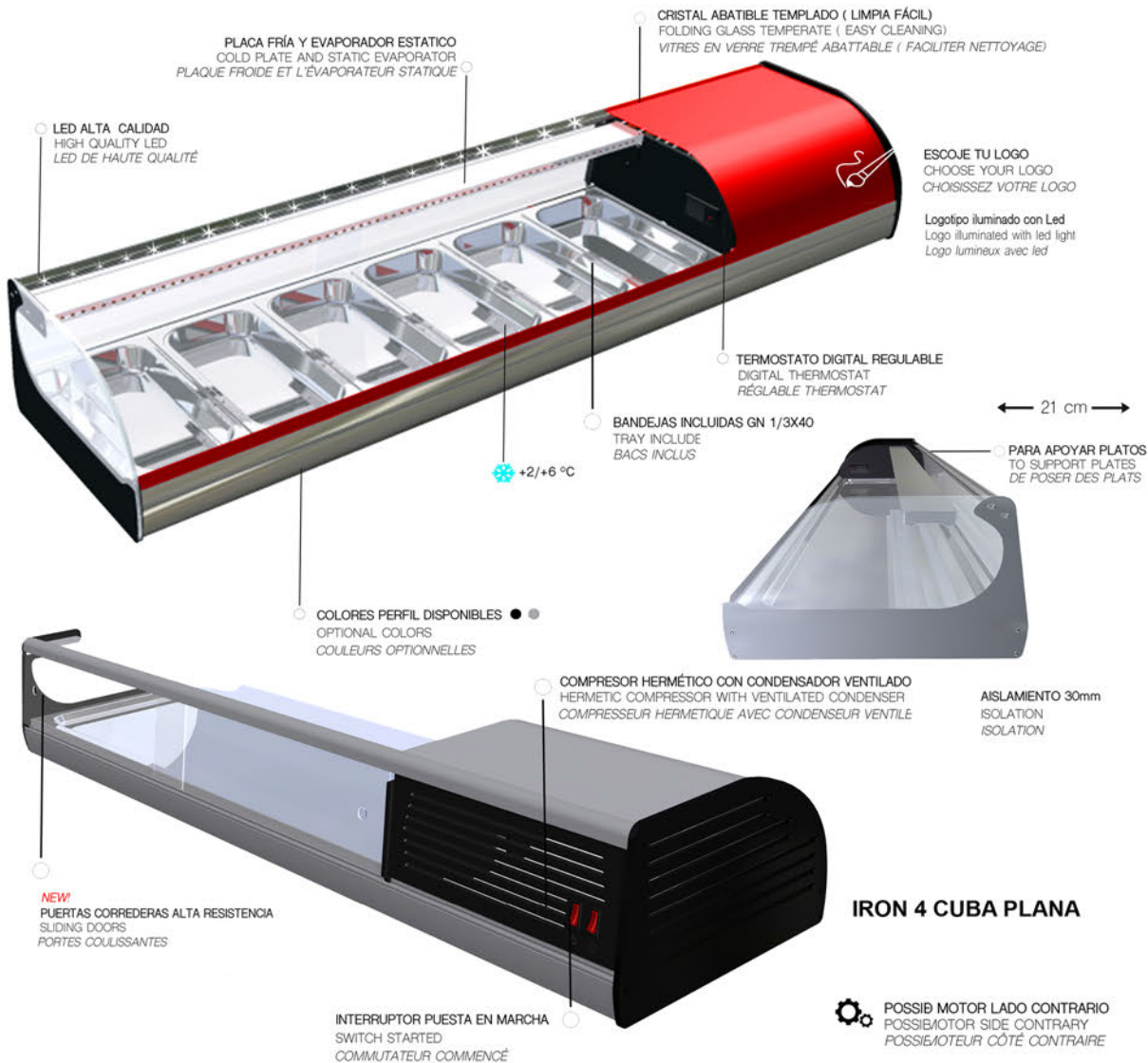

IRON 4 CUBA PLANA

IRON SUSHI



VITRINAS REFRIGERADAS CRISTAL CURVO ABATIBLE REFRIGERATED DISPLAY CASES CURVE CRYSTAL VITRINES RÉFRIGÉRÉES VITRE ABATTABLE COURBÉ

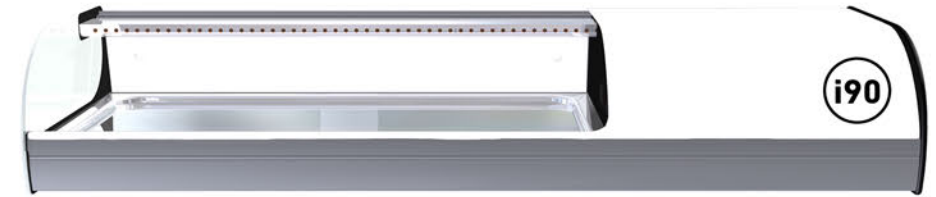

IRON SUSHI 4 CUBA PLANA



IRON SUSHI 6



COLORES DISPONIBLES
 CHOOSE YOUR COLOUR
 COULEURS DISPONIBLES



POSIBILIDAD CUBA PLANA
 POSSIBILITY OF FLAT PLATE
 POSSIBILITÉ DE CUVE PLANE (SANS BAC)



Modelo	Código			Dimensiones L x P x H (mm)	Pot. w	Temp. °C	Tensión V	Capacidad	Peso Kg	Precio euros
	Negra	Blanca	Roja							
IRON 4 SUSHI	877042	877048	877045	1146X390X215	160	+2°C/+6°C	230	4XGN1/3x40	24	886
IRON 6 SUSHI	877046	877049	877046	1487X390X215	160	+2°C/+6°C	230	6XGN1/3x40	34	954
IRON 8 SUSHI	877044	877050	877047	1826X390X215	160	+2°C/+6°C	230	8XGN1/3x40	40	1069
IRON 4 SUSHI CUBA PLANA	877051	877057	877054	1146X390X215	160	+2°C/+6°C	230	sin bandejas	24	886
IRON 6 SUSHI CUBA PLANA	877052	877058	877055	1487X390X215	160	+2°C/+6°C	230	sin bandejas	34	954
IRON 8 SUSHI CUBA PLANA	877053	877059	877056	1826X390X215	160	+2°C/+6°C	230	sin bandejas	40	1069

IRON 2 PISOS



CARACTERÍSTICAS CHARACTERISTICS CARACTÉRISTIQUES

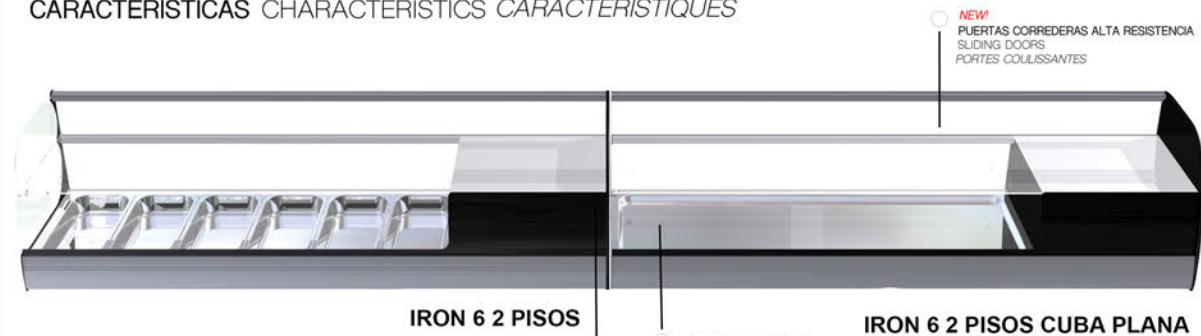

IRON 6 2 PISOS

IRON 6 2 PISOS CUBA PLANA

POSSIBILIDAD MOTOR LADO CONTRARIO
POSSIBILITY MOTOR SIDE CONTRARY
POSSIBILITÉ MOTEUR CÔTÉ CONTRAIRE

AISLAMIENTO 30mm
ISOLATION
ISOLATION

NEW!
PUERTAS CORREDERAS ALTA RESISTENCIA
SLIDING DOORS
PORTES COULISSANTES

ESTANTE DE CRISTAL
GLASS SHELF
ETAGÈRE EN VERRE

CRISTAL ABATIBLE TEMPLADO (LIMPIA FÁCIL)
FOLDING GLASS TEMPERATE (EASY CLEANING)
VITRES EN VERRE TREMPÉ ABATTABLE (FACILITER NETTOYAGE)

LED ALTA CALIDAD
HIGH QUALITY LED
LED DE HAUTE QUALITÉ

Logotipo iluminado con Led
Logo illuminated with led light
Logo lumineux avec led

ESCOJE TU LOGO
CHOOSE YOUR LOGO
CHOISISSEZ VOTRE LOGO

IRON 6 2 PISOS

TERMOSTATO DIGITAL REGULABLE
DIGITAL THERMOSTAT
RÉGLABLE THERMOSTAT

+2/+6 °C

COLORES PERFIL DISPONIBLES
OPTIONAL COLORS

PARA APOYAR PLATOS
TO SUPPORT PLATES
DE POSER DES PLATS



← 21 cm →

CUBA AISI 304 SIN ANGULOS
CUBA AISI 304 WITHOUT CORNERS
CUVE AISI 304 SANS ANGLE

ACCESORIOS ACCESSORIES ACCESSOIRES

JUEGO SOPORTES VITRINA
SUPPORT SET FOR DISPLAY CASES
JEU DE SUPPORTS EN SAILLIE POUR VITRINE



NEW!

JUEGO PUERTAS EFECTO ESPEJO
SPECIAL MIRROR EFFECT DOORS
JEU DE PORTES VITRÉES MIRROR



BANDEJAS COLORES
COLOR TRAYS
PLATEAUX COULEURS
NEW!



White Red Cristal Blue Inox



COLORES DISPONIBLES
CHOOSE YOUR COLOUR
COULEURS DISPONIBLES

POSSIBILIDAD CUBA PLANA
POSSIBILITY OF FLAT PLATE
POSSIBILITÉ DE CUVE PLANE (SANS BAC)

IRON 2 PISOS



INDUSTRIA 90

VITRINAS REFRIGERADAS CRISTAL CURVO ABATIBLE
REFRIGERATED DISPLAY CASES CURVE CRYSTAL
VITRINES RÉFRIGÉRÉES VITRE ABATTABLE COURBÉ



IRON 4 2 PISOS CUBA PLANA

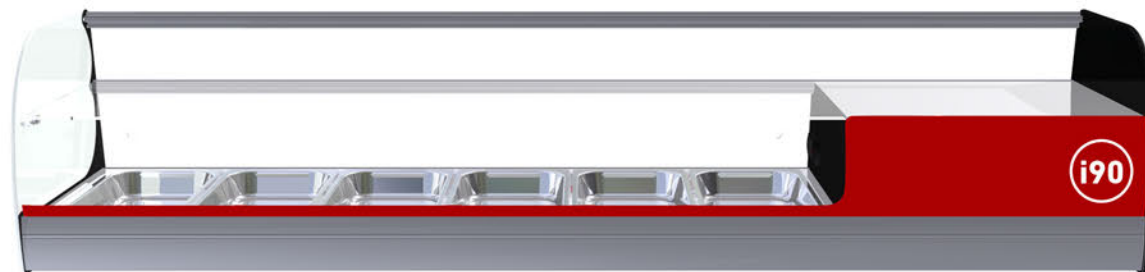

IRON 6 2 PISOS

Modelo	Código			Dimensiones L x P x H (mm)	Pot. w	Temp. °C	Tensión V	Capacidad	Peso Kg	Precio euros
	Negra	Blanca	Roja							
IRON 4 2 PISOS	877018	877030	877027	1146X390X315	160	+2°C/+6°C	230	4XGN1/3x40	30	981
IRON 6 2 PISOS	877019	877031	877028	1487X390X315	160	+2°C/+6°C	230	6XGN1/3x40	43	1059
IRON 8 2 PISOS	877020	877032	877029	1826X390X315	160	+2°C/+6°C	230	8XGN1/3x40	51	1101
IRON REMOTA 6 2 PISOS	876916	-	-	1146X390X315	160	+2°C/+6°C	230	6XGN1/3x40	38	1141
IRON REMOTA 8 2 PISOS	876917	-	-	1487X390X315	160	+2°C/+6°C	230	8XGN1/3x40	45	1254
IRON 4 2 PISOS CUBA PLANA	877060	877090	877091	1146X390X315	160	+2°C/+6°C	230	sin bandejas	30	981
IRON 6 2 PISOS CUBA PLANA	877061	877092	877093	1487X390X315	160	+2°C/+6°C	230	sin bandejas	43	1059
IRON 8 2 PISOS CUBA PLANA	877062	877094	877095	1826X390X315	160	+2°C/+6°C	230	sin bandejas	51	1101
IRON REMOTA 6 2 PISOS CUBA PLANA	876914	-	-	1146X390X315	160	+2°C/+6°C	230	sin bandejas	38	1141
IRON REMOTA 8 2 PISOS CUBA PLANA	876913	-	-	1487X390X315	160	+2°C/+6°C	230	sin bandejas	45	1254

CUB



Personaliza



LUZ



2°/6°C



BANDEJA GASTRONORM



ELÉCTRICA



COLORES DISPONIBLES

CARACTERÍSTICAS CHARACTERISTICS CARACTÉRISTIQUES

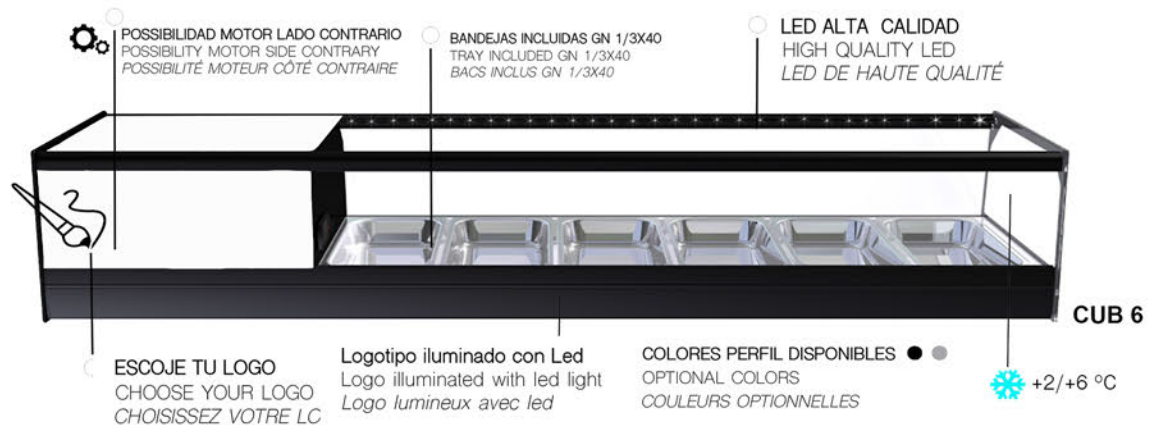

CUB 6

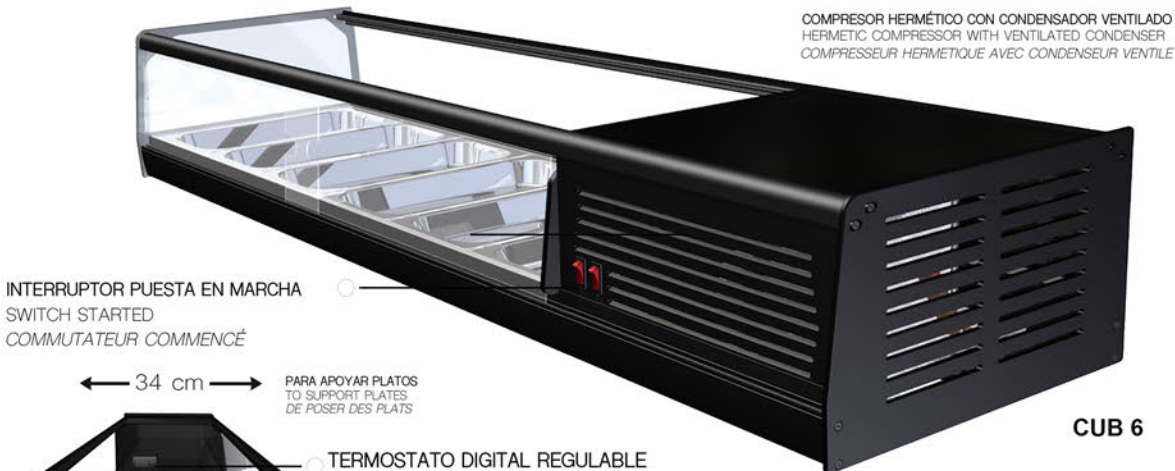

CUB 6



CUBA AISI 304 SIN ANGULOS
CUBA AISI 304 WITHOUT CORN
CUVE AISI 304 SANS ANGLE



COLORES DISPONIBLES
CHOOSE YOUR COLOUR
COULEURS DISPONIBLES

POSIBILIDAD CUBA PLANA
POSSIBILITY OF FLAT PLATE
POSSIBILITÉ DE CUVE PLANE (SANS BAC)

ACCESORIOS

JUEGO SOPORTES VITRINA
SUPPORT SET FOR DISPLAY CASES
JEU DE SUPPORTS EN SAILLIE POUR VITRINE



NEW!



JUEGO PUERTAS EFECTO ESPEJO
SPECIAL MIRROR EFFECT DOORS
JEU DE PORTES VITRÉES MIROIR



NEW!
BANDEJAS COLORES COLOR TRAYS PLATEAUX COULEURS

CUB



INDUSTRIA 90

VITRINAS REFRIGERADAS CRISTAL PLANO REFRIGERATED DISPLAY CASES STRAIGHT CRYSTAL VITRINES RÉFRIGÉRÉES VITRE CRISTAL DROIT



CUB 6 PLACA FRÍA

CUB 6 NEUTRA

CUB 6 HOT



CUB 4 CUBA PLANA



CUB 6

Modelo	Código			Dimensiones L x P x H (mm)	Pot. w	Temp. °C	Tensión V	Capacidad	Peso Kg	Precio euros
	Negra	Blanca	Roja							
CUB 4	307000	307003	307006	1146X390X252	160	+2°C/+6°C	230	4XGN1/3x40	24	925
CUB 6	307001	307004	307007	1487X390X252	160	+2°C/+6°C	230	6XGN1/3x40	34	1022
CUB 8	307002	307005	307008	1826X390X252	160	+2°C/+6°C	230	8XGN1/3x40	40	1107
CUB 4 CUBA PLANA	306990	306993	306996	1146X390X252	160	+2°C/+6°C	230	sin bandejas	24	925
CUB 6 CUBA PLANA	306991	306994	306997	1487X390X252	160	+2°C/+6°C	230	sin bandejas	34	1022
CUB 8 CUBA PLANA	306992	306995	306998	1826X390X252	160	+2°C/+6°C	230	sin bandejas	40	1107
CUB 4 REMOTA	307009			805X390X252	160	+2°C/+6°C	230	4XGN1/3x40	22	1056
CUB 6 REMOTA	307010			1146X390X252	160	+2°C/+6°C	230	6XGN1/3x40	32	1164
CUB 8 REMOTA	307011			1487X390X252	160	+2°C/+6°C	230	8XGN1/3x40	38	1278

CUB 2 PISOS



CARACTERÍSTICAS CHARACTERISTICS CARACTÉRISTIQUES

Logotipo iluminado con Led
Logo illuminated with led light
Logo lumineux avec led

TERMOSTATO DIGITAL REGULABLE
DIGITAL THERMOSTAT
RÉGLABLE THERMOSTAT

LED ALTA CALIDAD
HIGH QUALITY LED
LED DE HAUTE QUALITÉ

CUB 6 2 PISOS

COLORES PERFIL DISPONIBLES ● ●
OPTIONAL COLORS
COULEURS OPTIONNELLES

NEW
PUERTAS CORREDEAS ALTA RESISTENCIA
SLIDING DOORS
PORTES COUSSANTES

+2/+6 °C

BANDEJAS INCLUIDAS GN 1/3X40
TRAY INCLUDED GN 1/3X40
BACS INCLUS GN 1/3X40

PARA APOYAR PLATOS
TO SUPPORT PLATES
DE POSER DES PLATS

34 cm

INTERRUPTOR PUESTA EN MARCHA
SWITCH STARTED
COMMUTATEUR COMMENCÉ

COMPRESOR HERMÉTICO CON CONDENSADOR VENTILADO
HERMETIC COMPRESSOR WITH VENTILATED CONDENSER
COMPRESSEUR HERMETIQUE AVEC CONDENSEUR VENTILE

CUB 8 2 PISOS

POSSIBILIDAD MOTOR LADO CONTRARIO
POSSIBILITY MOTOR SIDE CONTRARY
POSSIBILITÉ MOTEUR CÔTÉ CONTRAIRE

ACCESORIOS

JUEGO SOPORTES VITRINA
SUPPORT SET FOR DISPLAY CASES
JEU DE SUPPORTS EN SAILLIE POUR VITRINE

NEW!

JUEGO PUERTAS EFECTO ESPEJO
SPECIAL MIRROR EFFECT DOORS
JEU DE PORTES VITRÉES MIROIR

White Red Cristal Blue Inox

NEW!
BANDEJAS COLORES COLOR TRAYS PLATEAUX COULEURS

COLORES DISPONIBLES
CHOOSE YOUR COLOUR
COULEURS DISPONIBLES

POSIBILIDAD CUBA PLANA
POSSIBILITY OF FLAT PLATE
POSSIBILITÉ DE CUVE PLANE (SANS BAC)

ISLAMIENTO 30mm
ISOLATION
ISOLATION

CUBA AISI 304 SIN ANGULOS
CUBA AISI 304 WITHOUT CORN
CUVE AISI 304 SANS ANGLE

CUB 2 PISOS



INDUSTRIA 90

VITRINAS REFRIGERADAS CRISTAL PLANO REFRIGERATED DISPLAY CASES STRAIGHT CRYSTAL VITRINES RÉFRIGÉRÉES VITRE CRISTAL DROIT



CUB 4 CUBA PLANA 2 PISOS



CUB 6 2 PISOS

Modelo	Código			Dimensiones L x P x H (mm)	Pot. w	Temp. °C	Tensión V	Capacidad	Peso Kg	Precio euros
	Negra	Blanca	Roja							
CUB 4 2 PISOS	307069	307075	307078	1146X390X330	160	+2°C/+6°C	230	4XGN1/3x40	24	1036
CUB 6 2 PISOS	307070	307076	307079	1487X390X330	160	+2°C/+6°C	230	6XGN1/3x40	34	1169
CUB 8 2 PISOS	307071	307077	307080	1826X390X330	160	+2°C/+6°C	230	8XGN1/3x40	40	1205
CUB 4 2 PISOS CUBA PLANA	307074	307081	307084	1146X390X330	160	+2°C/+6°C	230	sin bandejas	24	1036
CUB 6 2 PISOS CUBA PLANA	307072	307082	307085	1487X390X330	160	+2°C/+6°C	230	sin bandejas	34	1169
CUB 8 2 PISOS CUBA PLANA	307073	308073	307086	1826X390X330	160	+2°C/+6°C	230	sin bandejas	40	1205
CUB 4 REMOTA 2 PISOS	307012	-	-	805X390X330	160	+2°C/+6°C	230	4XGN1/3x40	22	1254
CUB 6 REMOTA 2 PISOS	307013	-	-	1146X390X330	160	+2°C/+6°C	230	6XGN1/3x40	32	1332
CUB 8 REMOTA 2 PISOS	307014	-	-	1487X390X330	160	+2°C/+6°C	230	8XGN1/3x40	38	1375

NEW

CUB COLD 2 PISOS



CARACTERÍSTICAS CHARACTERISTICS CARACTÉRISTIQUES

LED ALTA CALIDAD
HIGH QUALITY LED
LED DE HAUTE QUALITÉ

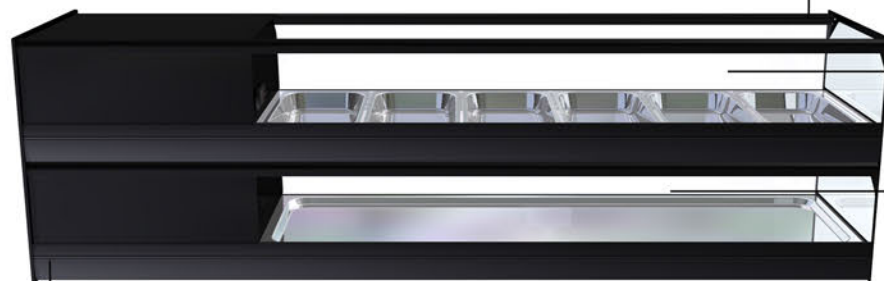

CUB 6 COLD 2 PISOS

CUB 6 COLD 2 PISOS
CUBA PLANA

COLORES PERFIL DISPONIBLES
OPTIONAL COLORS
COULEURS OPTIONNELLES

BANDEJAS INCLUIDAS GN 1/3X40
TRAY INCLUDED GN 1/3X40
BACS INCLUS GN 1/3X40

CUB 6 COLD 2 PISOS

NEW
PUERTAS CORREDERAS ALTA RESISTENCIA
SLIDING DOORS
PORTES COULISSANTES

Logotipo iluminado con Led
Logo illuminated with led light
Logo lumineux avec led

CUBA AISI 304 SIN ANGULOS
CUBA AISI 304 WITHOUT CORN
CUVE AISI 304 SANS ANGLE

PARA APOYAR PLATOS
TO SUPPORT PLATES
DE POSER DES PLATS

34 cm



COMPRESOR HERMÉTICO CON CONDENSADOR VENTILADO
HERMETIC COMPRESSOR WITH VENTILATED CONDENSER
COMPRESSEUR HERMETIQUE AVEC CONDENSEUR VENTILE

AISLAMIENTO 30mm
ISOLATION
ISOLATION

TERMOSTATO DIGITAL REGULABLE
DIGITAL THERMOSTAT
RÉGLABLE THERMOSTAT

POSSIBILIDAD CUBA PLANA
POSSIBILITY OF FLAT PLATE
POSSIBILITÉ DE CUVE PLANE (SANS BAC)



COLORES DISPONIBLES
CHOOSE YOUR COLOUR
COULEURS DISPONIBLES

ACCESORIOS ACCESSORIES ACCESSOIRES

JUEGO SOPORTES VITRINA
SUPPORT SET FOR DISPLAY CASES
JEU DE SUPPORTS EN SAILLIE POUR VITRINE



NEW!

JUEGO PUERTAS EFECTO ESPEJO
SPECIAL MIRROR EFFECT DOORS
JEU DE PORTES VITRÉES MIROIR



White Red Cristal Blue Inox

BANDEJAS COLORES
COLOR TRAYS
PLATEAUX COULEURS
NEW!

NEW

CUB COLD 2 PISOS



INDUSTRIA 90

VITRINA REFRIGERADA CRISTAL PLANO DOBLE FRÍO
DOUBLE COLD DISPLAY CASE CRYSTAL GLASS COOLER
VITRINES RÉFRIGÉRÉES CRISTAUX DOUBLES REFROIDIS



CUB 4 COLD 2 PISOS

Modelo	Código			Dimensiones L x P x H (mm)	Pot. w	Temp. °C	Tensión V	Capacidad	Peso Kg	Precio euros
	Negra	Blanca	Roja							
CUB COLD 4 2 PISOS	306984	306985	306986	1146X390X515	320	+2°C/+6°C	230	4XGN1/3x40	48	1700
CUB COLD 6 2 PISOS	306987	306988	306989	1487X390X515	320	+2°C/+6°C	230	6XGN1/3x40	68	1850

ONIX



CARACTERÍSTICAS CHARACTERISTICS CARACTÉRISTIQUES

ESCOJE TU LOGO
CHOOSE YOUR LOGO
CHOISISSEZ VOTRE LOGO

CRISTAL ABATIBLE TEMPLADO (LIMPIA FÁCIL)
FOLDING GLASS TEMPERATE (EASY CLEANING)
VITRES EN VERRRE TREMPÉ ABATTABLE (FACILITER NETTOYAGE)

LED ALTA CALIDAD
HIGH QUALITY LED
LED DE HAUTE QUALITÉ

BANDEJAS INCLUIDAS GN 1/3X40
TRAY INCLUDED GN 1/3X40
BACS INCLUS GN 1/3X40

POSSIBILIDAD MOTOR LADO CONTRARIO
POSSIBILITY MOTOR SIDE CONTRARY
POSSIBILITE MOTEUR CÔTÉ CONTRAIRE

Logotipo iluminado con Led
Logo illuminated with led light
Logo lumineux avec led

TERMOSTATO DIGITAL REGULABLE
DIGITAL THERMOSTAT
RÉGLABLE THERMOSTAT

NEW!
PUERTAS CORREDERAS ALTA RESISTENCIA
SLIDING DOORS
PORTES COULISSANTES

COLORES PERFIL DISPONIBLES
OPTIONAL COLORS
COULEURS OPTIONNELLES

+2/+6 °C

ONIX 6



ONIX 6

12 cm

PARA APOYAR PLATOS
TO SUPPORT PLATES
DE POSER DES PLATS

AISLAMIENTO 30mm
ISOLATION
ISOLATION

INTERRUPTOR PUESTA EN MARCHA
SWITCH STARTED
COMMUNTEUR COMMENCÉ

COMPRESOR HERMÉTICO CON CONDENSADOR VENTILADO
HERMETIC COMPRESSOR WITH VENTILATED CONDENSER
COMPRESSEUR HERMETIQUE AVEC CONDENSEUR VENTILE

CUBA AISI 304 SIN ANGULOS
CUBA AISI 304 WITHOUT CORNERS
CUVE AISI 304 SANS ANGLE

ACCESORIOS

JUEGO SOPORTES VITRINA
SUPPORT SET FOR DISPLAY CASES
JEU DE SUPPORTS EN SAILLIE POUR VITRINE



NEW!



JUEGO PUERTAS EFECTO ESPEJO
SPECIAL MIRROR EFFECT DOORS
JEU DE PORTES VITRÉES MIROIR



White Red Cristal Blue Inox

NEW!
BANDEJAS COLORES COLOR TRAYS PLATEAUX COULEURS

POSSIBILIDAD CUBA PLANA
POSSIBILITY OF FLAT PLATE
POSSIBILITÉ DE CUVE PLANE (SANS BAC)

COLORES DISPONIBLES
CHOOSE YOUR COLOUR
COULEURS DISPONIBLES

ONIX



VITRINAS REFRIGERADAS CRISTAL DOBLE CURVA REFRIGERATED DISPLAY CASES DOUBLE CURVE CRYSTAL VITRINES RÉFRIGÉRÉES VITRE DOUBLE COURBE



ONIX 6 REMOTA



ONIX 6

Modelo	Código			Dimensiones L x P x H (mm)	Pot. w	Temp. °C	Tensión V	Capacidad	Peso Kg	Precio euros
	Negra	Blanca	Roja							
ONIX 4	306900	306901	306902	1146X390X227	160	+2°C/+6°C	230	4XGN1/3x40	24	859
ONIX 6	306903	306904	306905	1487X390X227	160	+2°C/+6°C	230	6XGN1/3x40	34	969
ONIX 8	306906	306907	306908	1826X390X227	160	+2°C/+6°C	230	8XGN1/3x40	40	1054
ONIX REMOTA 6	306909			1146X390X227	160	+2°C/+6°C	230	6XGN1/3x40	32	1090
ONIX REMOTA 8	306910			1487X390X227	160	+2°C/+6°C	230	8XGN1/3x40	35	1188
ONIX 4 CUBA PLANA	306937	306938	306939	1146X390X227	160	+2°C/+6°C	230	sin bandejas	24	859
ONIX 6 CUBA PLANA	306911	306912	306913	1487X390X227	160	+2°C/+6°C	230	sin bandejas	34	969
ONIX 8 CUBA PLANA	306914	306915	306916	1826X390X227	160	+2°C/+6°C	230	sin bandejas	40	1054
ONIX REMOTA 6 CUBA PLANA	306918			1146X390X227	160	+2°C/+6°C	230	sin bandejas	32	1090
ONIX REMOTA 8 CUBA PLANA	306919			1487X390X227	160	+2°C/+6°C	230	sin bandejas	35	1188



CARACTERÍSTICAS CHARACTERISTICS CARACTÉRISTIQUES

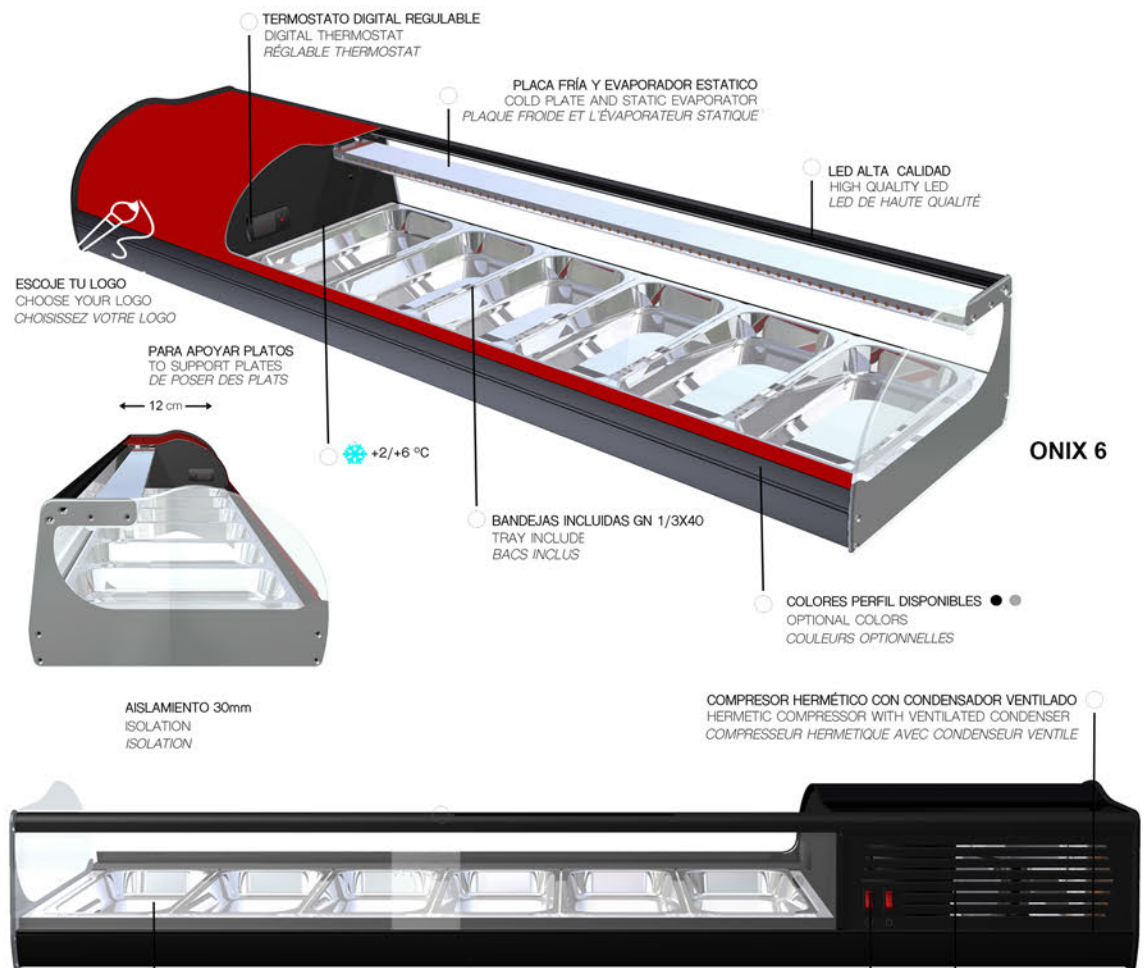

ONIX 6



ONIX 6

ACCESORIOS

JUEGO SOPORTES VITRINA
SUPPORT SET FOR DISPLAY CASES
JEU DE SUPPORTS EN SAILLIE POUR VITRINE

NEW!

JUEGO PUERTAS EFECTO ESPEJO
SPECIAL MIRROR EFFECT DOORS
JEU DE PORTES VITRÉES MIROIR

White Red Cristal Blue Inox

NEW!
BANDEJAS COLORES COLOR TRAYS PLATEAUX COULEURS



POSSIBILIDAD CUBA PLANA
POSSIBILITY OF FLAT PLATE
POSSIBILITÉ DE CUVE PLANE (SANS BAC)

COLORES DISPONIBLES
CHOOSE YOUR COLOUR
COULEURS DISPONIBLES

VITRINAS REFRIGERADAS CRISTAL DOBLE CURVA REFRIGERATED DISPLAY CASES DOUBLE CURVE CRYSTAL VITRINES RÉFRIGÉRÉES VITRE DOUBLE COURBE



ONIX 6 CUBA PLANA



ONIX 6

Modelo	Código			Dimensiones L x P x H (mm)	Pot. w	Temp. °C	Tensión V	Capacidad	Peso Kg	Precio euros
	Negra	Blanca	Roja							
ONIX 4 SUSHI	306964	306965	306966	1146X390X227	160	+2°C/+6°C	230	4XGN1/3x40	24	960
ONIX 6 SUSHI	306928	306929	306930	1487X390X227	160	+2°C/+6°C	230	6XGN1/3x40	34	1026
ONIX 8 SUSHI	306931	306932	306933	1826X390X227	160	+2°C/+6°C	230	8XGN1/3x40	40	1162
ONIX 4 SUSHI CUBA PLANA	306958	306959	306960	1146X390X227	160	+2°C/+6°C	230	sin bandejas	24	960
ONIX 6 SUSHI CUBA PLANA	306952	306953	306954	1487X390X227	160	+2°C/+6°C	230	sin bandejas	34	1026
ONIX 8 SUSHI CUBA PLANA	306955	306956	306957	1826X390X227	160	+2°C/+6°C	230	sin bandejas	40	1162

ONIX 2 PISOS

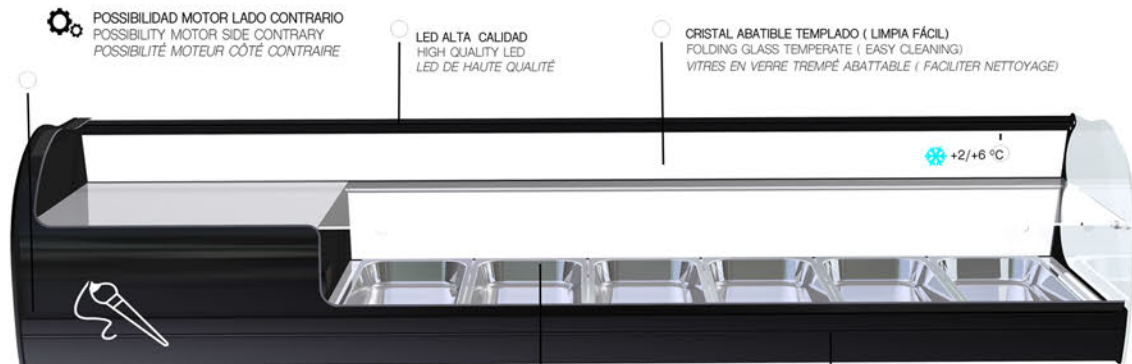

POSSIBILIDAD MOTOR LADO CONTRARIO
POSSIBILITY MOTOR SIDE CONTRARY
POSSIBILITÉ MOTEUR CÔTÉ CONTRAIRE

LED ALTA CALIDAD
HIGH QUALITY LED
LED DE HAUTE QUALITÉ

CRISTAL ABATIBLE TEMPLADO (LIMPIA FÁCIL)
FOLDING GLASS TEMPERATE (EASY CLEANING)
VITRES EN VERRRE TREMPÉ ABATTABLE (FACILITER NETTOYAGE)

ESCOJE TU LOGO
CHOOSE YOUR LOGO
CHOISISSEZ VOTRE LOGO

Logotipo iluminado con Led
Logo illuminated with led light
Logo lumineux avec led

BANDEJAS INCLUIDAS GN 1/3X40
TRAY INCLUDED GN 1/3X40
BACS INCLUS GN 1/3X40

ONIX 6 2 PISOS

COLORES PERFIL DISPONIBLES ● ● ●
OPTIONAL COLORS
COULEURS OPTIONNELLES



NEW!
PUERTAS CORREDERAS ALTA RESISTENCIA
SLIDING DOORS
PORTES COULISSANTES

INTERRUPTOR PUESTA EN MARCHA
SWITCH STARTED
COMMUTEUR COMMENCÉ

ONIX 6 2 PISOS

COMPRESOR HERMÉTICO CON CONDENSADOR VENTILADO
HERMETIC COMPRESSOR WITH VENTILATED CONDENSER
COMPRESSEUR HERMETIQUE AVEC CONDENSEUR VENTILE



AISLAMIENTO 30mm
 ISOLATION
 ISOLATION

CUBA AISI 304 SIN ANGULOS
CUBA AISI 304 WITHOUT CORN
CUVE AISI 304 SANS ANGLE

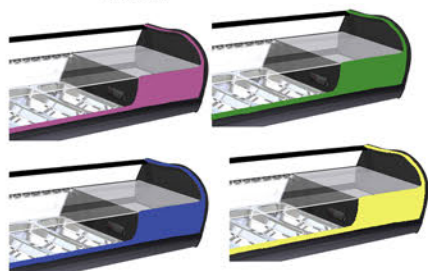

CHOOSE YOUR COLOUR
COULEURS DISPONIBLES

POSSIBILIDAD CUBA PLANA
POSSIBILITY OF FLAT PLATE
POSSIBILITÉ DE CUVE PLANE (SANS BAC)

ACCESORIOS

JUEGO SOPORTES VITRINA
SUPPORT SET FOR DISPLAY CASES
JEU DE SUPPORTS EN SAILUE POUR VITRINE



NEW!



JUEGO PUERTAS EFECTO ESPEJO
SPECIAL MIRROR EFFECT DOORS
JEU DE PORTES VITRÉES MIROIR



White Red Cristal Blue Inox

NEW!
BANDEJAS COLORES COLOR TRAYS PLATEAUX COULEURS

ONIX 2 PISOS



INDUSTRIA 90

VITRINAS REFRIGERADAS CRISTAL DOBLE CURVA
REFRIGERATED DISPLAY CASES DOUBLE CURVE CRYSTAL
VITRINES RÉFRIGÉRÉES VITRE DOUBLE COURBE



ONIX 6 2 PISOS



ONIX 6 2 PISOS

Modelo	Código			Dimensiones L x P x H (mm)	Pot. w	Temp. °C	Tensión V	Capacidad	Peso Kg	Precio euros
	Negra	Blanca	Roja							
ONIX 6 2 PISOS	306920	306921	306922	1487X390X330	160	+2°C/+6°C	230	6XGN1/3x40	34	1159
ONIX 8 2 PISOS	306923	306924	306925	1826X390X330	160	+2°C/+6°C	230	8XGN1/3x40	40	1201
ONIX REMOTA 6 2 PISOS	306926			1146X390X330	160	+2°C/+6°C	230	6XGN1/3x40	32	1241
ONIX REMOTA 8 2 PISOS	306927			1487X390X330	160	+2°C/+6°C	230	8XGN1/3x40	35	1354

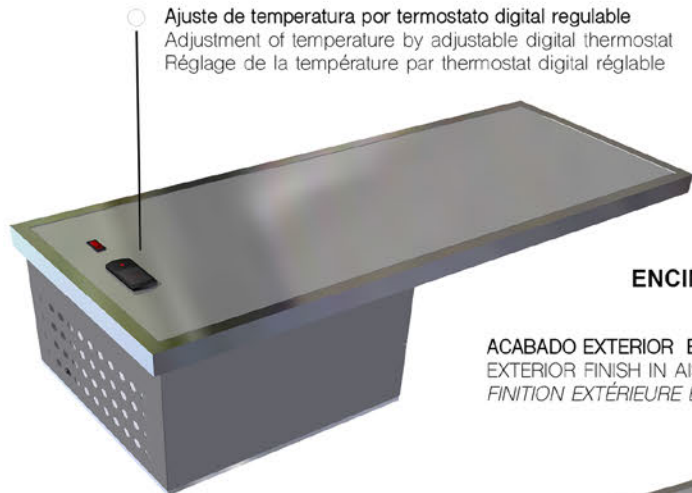

ENCIMERA 1000 CON GRUPO MOTOR

ACABADO EXTERIOR EN TUBO PERIMETRAL ACERO INOXIDABLE AISI 304
EXTERIOR FINISH IN AISI 304 STAINLESS STEEL PERIMETER TUBE
FINITION EXTÉRIEURE EN TUBE À PÉRIMÈTRE EN ACIER INOX AISI 304

POSSIBILIDAD MOTOR LADO CONTRARIO
POSSIBILITY MOTOR SIDE CONTRARY
POSSIBILITÉ MOTEUR CÔTÉ CONTRAIRE

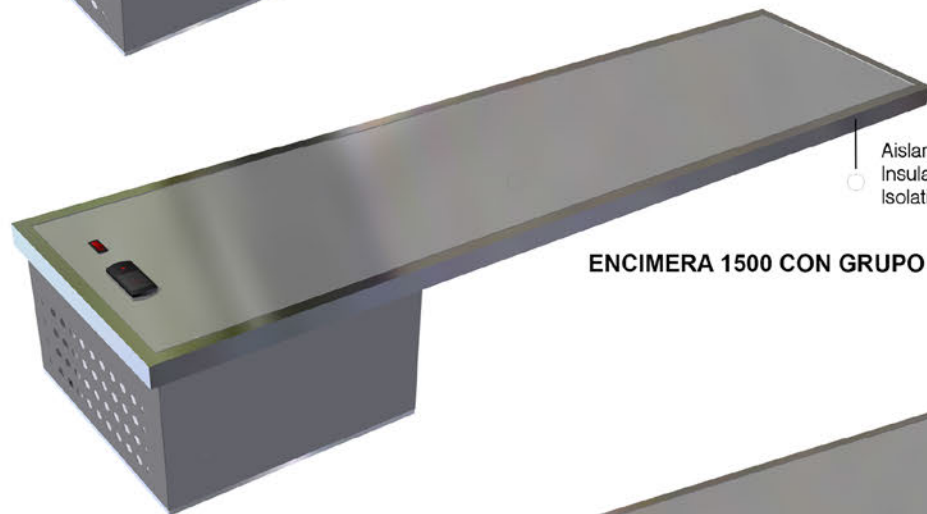

ENCIMERA 1500 CON GRUPO MOTOR

Aislamiento 30 mm
Insulation 30 mm
Isolation 30 mm

Base Plana AISI 304
Flat Base AISI 304
Base plate AISI 304

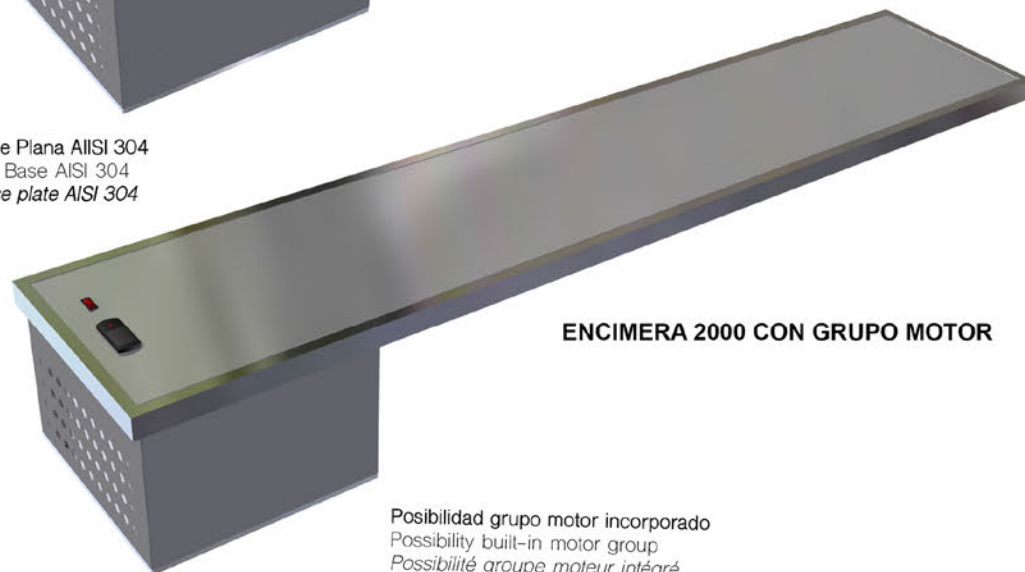

ENCIMERA 2000 CON GRUPO MOTOR

Posibilidad grupo motor incorporado
Possibility built-in motor group
Possibilité groupe moteur intégré



* DISPONIBILIDAD EN FRIO Y EN CALOR

Modelo	Código	Dimensiones L x P x H (mm)	Potencia w	Temperatura °C	Tensión V	Capacidad	Peso Kg	Precio euros
ENCIMERA 1000	306561	1000X400X50			230	sin bandejas	5	777
ENCIMERA 1500	306562	1500X400X50			230	sin bandejas	7	898
ENCIMERA 2000	306563	2000X400X50			230	sin bandejas	9	1020
ENCIMERA 1000 CON GRUPO MOTOR	306564	1000X400X330	160	+2°C/+6°C	230	sin bandejas	10	977
ENCIMERA 1500 CON GRUPO MOTOR	306565	1500X400X330	160	+2°C/+6°C	230	sin bandejas	12	1260
ENCIMERA 2000 CON GRUPO MOTOR	306566	2000X400X330	160	+2°C/+6°C	230	sin bandejas	14	1465

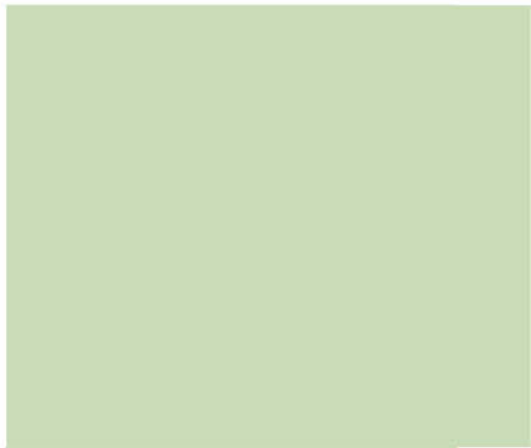
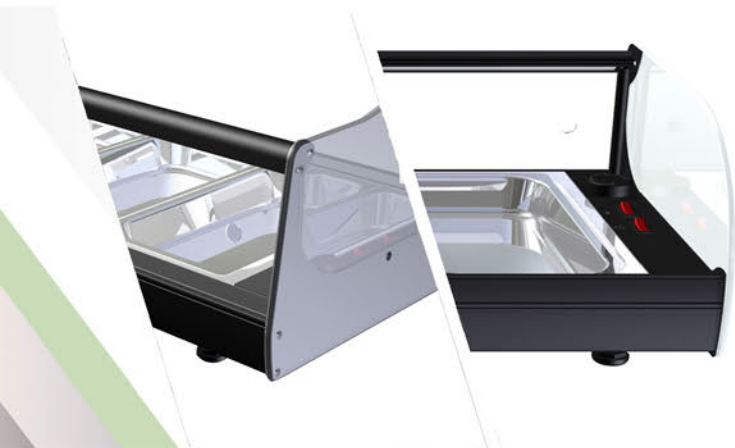
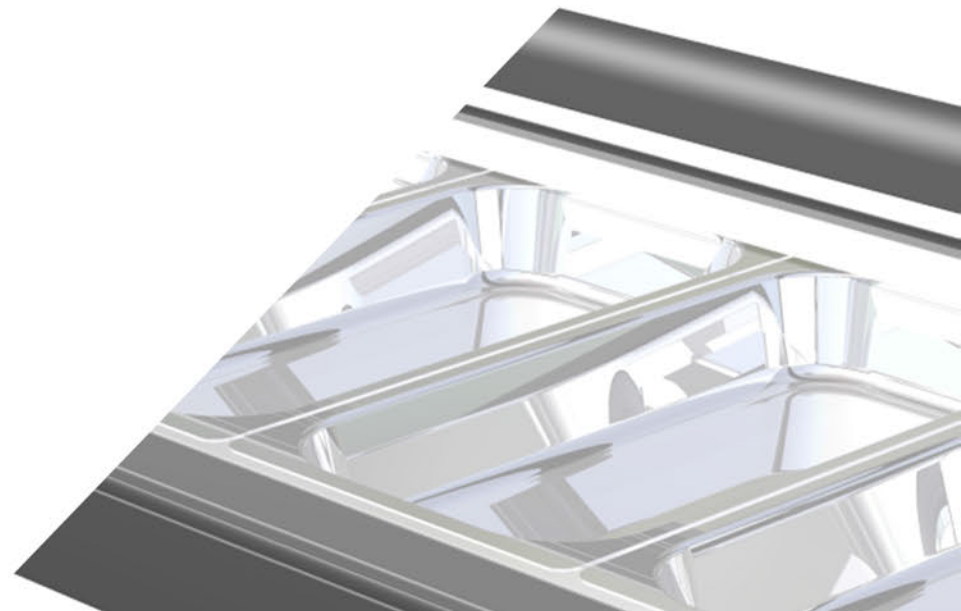

VITRINAS CALIENTES
HOT DISPLAY CASES
VITRINES CHAUDES

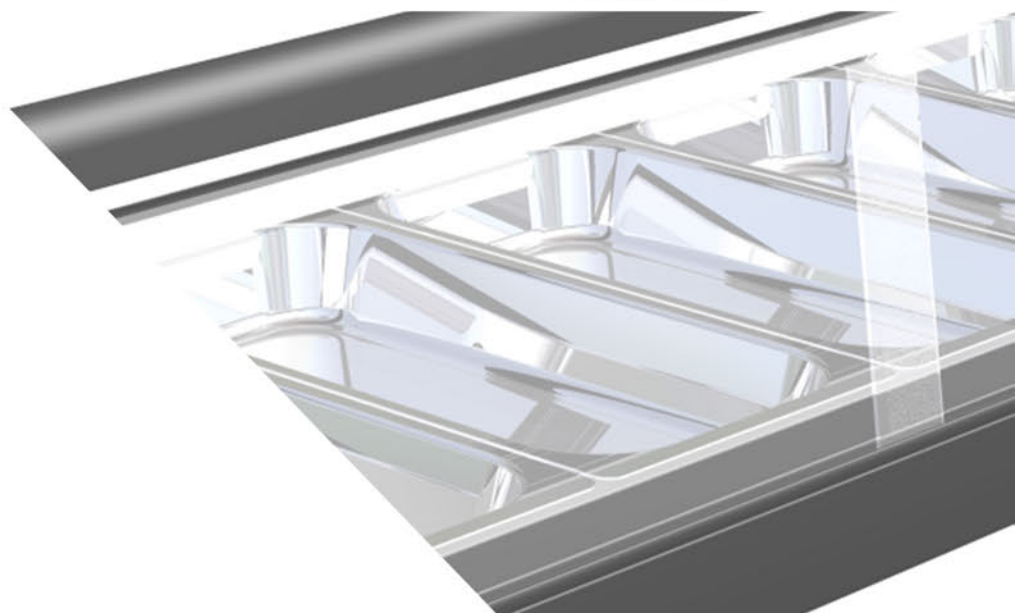

CALENTADOR TAPAS IRON

CALENTADOR TAPAS IRON

CARACTERÍSTICAS CHARACTERISTICS CARACTÉRISTIQUES

VITRINAS CALIENTES CRISTAL CURVO ABATIBLE
HOT DISPLAY CASES CURVE CRYSTAL
VITRINES CHAUD CRISTAL VITRE ABATTABLE COURBÉ



Puertas correderas de alta resistencia
High resistance sliding doors
Portes coulissantes à haute résistance

IRON 6 HOT



Ajuste de temperatura por termostato digital regulable
Adjustment of temperature by adjustable digital thermostat
Réglage de la température par thermostat digital réglable

LED ALTA CALIDAD
HIGH QUALITY LED
LED DE HAUTE QUALITÉ

ESCOJE TU LOGO
CHOOSE YOUR LOGO
CHOISISSEZ VOTRE LOGO

COLORES PERFIL DISPONIBLES ● ●
OPTIONAL COLORS
COULEURS OPTIONNELLES

IRON 6 HOT

AISLAMIENTO POLIURETANO INYECTADO DE 30 MM DE ESPESOR, LIBRE DE CFC'S Y DENSIDAD DE 40 KG/M
 INSULATED POLYURETHANE INSULATION OF 30 MM THICKNESS, FREE OF CFC'S AND DENSITY OF 40 KG / M
 ISOLANT ISOLÉ EN POLYURÉTHANE D'UNE ÉPAISSEUR DE 30 MM, EXEMPT DE CFC ET D'UNE DENSITÉ DE 40 KG / M

CUBA AISI 304 SIN ANGULOS
CUBA AISI 304 WITHOUT CORNERS
CUVE AISI 304 SANS ANGLE

FUNCIONAMIENTO CON AGUA
OPERATION WITH WATER
FONCTIONNEMENT AVEC DE L'EAU

ACCESORIOS ACCESSORIES ACCESSOIRES

NEW!

JUEGO SOPORTES VITRINA
SUPPORT SET FOR DISPLAY CASES
JEU DE SUPPORTS EN CHAÎNE POUR VITRINE

JUEGO PUERTAS EFECTO ESPEJO
SPECIAL MIRROR EFFECT DOORS
JEU DE PORTES VITRES MIRROR

NEW!

BANDEJAS COLORES
COLOR TRAYS
PLATEAUX COULEURS

White Red Cristal Blue Inox



BAÑO MARÍA
WATER BATH
BAIN-MARIE



INDUSTRIA 90

IRON 6 HOT

* Vitrinas Hot : con cable calefactor
* Calentadores : con resistencia

Modelo	Código	Dimensiones	Potencia	Temperatura	Tensión	Capacidad	Peso	Precio
		L x P x H (mm)	w	°C	V	Kg	euros	
IRON 4 HOT BAÑO MARIA	306981	807X390X215	260	+30°C/+90°C	230	4XGN1/3x40	20	490
IRON 6 HOT BAÑO MARIA	306982	1146X390X215	340	+30°C/+90°C	230	6XGN1/3x40	28	520
IRON 8 HOT BAÑO MARIA	306983	1457X390X215	460	+30°C/+90°C	230	8XGN1/3x40	35	550
IRON 4 CALENTADOR BAÑO MARIA	807094	807X390X215	1000	+30°C/+90°C	230	4XGN1/3x40	20	490
IRON 6 CALENTADOR BAÑO MARIA	807095	1146X390X215	1000	+30°C/+90°C	230	6XGN1/3x40	28	520

CALENTADOR TAPAS CUB

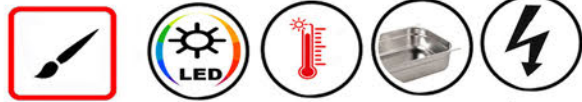

Personaliza LUZ 0°C/90°C BANDEJA GASTRONORM ELÉCTRICA

CARACTERÍSTICAS CHARACTERISTICS CARACTÉRISTIQUES



Superficie plana para apoyar los platos
Flat surface to support the dishes
Surface plane pour supporter la vaisselle



34 cm

Cristal plano
Flat crystal
Cristal plat

Gran visibilidad del producto
Great visibility of the product
Grande visibilité du produit



AISLAMIENTO POLIURETANO INYECTADO DE 30 MM DE ESPESOR ,
LIBRE DE CFC'S Y DENSIDAD DE 40 KG/M
INSULATED POLYURETHANE INSULATION OF 30 MM THICKNESS,
FREE OF CFC'S AND DENSITY OF 40 KG / M
ISOLANT ISOLÉ EN POLYURÉTHANE D'UNE ÉPAISSEUR DE 30 MM,
EXEMPT DE CFC ET D'UNE DENSITÉ DE 40 KG / M



Puertas correderas de alta resistencia
High resistance sliding doors
Portes coulissantes à haute résistance



POSIBILIDAD CUBA PLANA
POSSIBILITY OF FLAT PLATE
POSSIBILITÉ DE CUBE PLANE (SANS BAC)

CALENTADOR TAPAS CUB

VITRINAS CALIENTES CRISTAL PLANO
HOT DISPLAY CASES STRAIGHT CRYSTAL
VITRINES CHAUD CRISTAL DROIT



CUB 6 HOT BAÑO MARÍA

* Vitrinas Hot : con cable calefactor
* Calentadores : con resistencia

Modelo	Código	Dimensiones L x P x H (mm)	Potencia w	Temperatura °C	Tensión V	Capacidad	Peso Kg	Precio euros
CUB 4 HOT BAÑO MARIA	307023	807X390X252	260	+30°C/+90°C	230	4XGN1/3x40	20	713
CUB 6 HOT BAÑO MARIA	307024	1146X390X252	340	+30°C/+90°C	230	6XGN1/3x40	28	753
CUB 8 HOT BAÑO MARIA	307025	1457X390X252	460	+30°C/+90°C	230	8XGN1/3x40	35	778
CUB 4 CALENTADOR BAÑO MARIA	807096	807X390X252	260	+30°C/+90°C	230	4XGN1/3x40	20	713
CUB 6 CALENTADOR BAÑO MARIA	807097	1146X390X252	340	+30°C/+90°C	230	6XGN1/3x40	28	753

CALENTADOR TAPAS ONIX

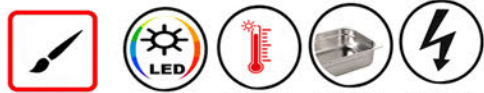

Personaliza LUZ 0°C/90°C BANDEJA GASTRONORM ELÉCTRICA

CARACTERÍSTICAS CHARACTERISTICS CARACTÉRISTIQUES

Acabado en aluminio anodizado negro
Finished in black anodized aluminum
Fini en aluminium anodisé noir

LED ALTA CALIDAD
HIGH QUALITY LED
LED DE HAUTE QUALITÉ



ONIX 6 HOT

COLORES PERFIL DISPONIBLES
OPTIONAL COLORS
COULEURS OPTIONNELLES

Cristal templado abatible para fácil limpieza
Folding tempered glass for easy cleaning
Verre trempé pliant pour un nettoyage facile

ESCOJE TU LOGO
CHOOSE YOUR LOGO
CHOISISSEZ VOTRE LOGO

Elegante cristal curvo con máxima visibilidad
Elegant curved glass with maximum visibility
Verre courbé élégant avec une visibilité maximale

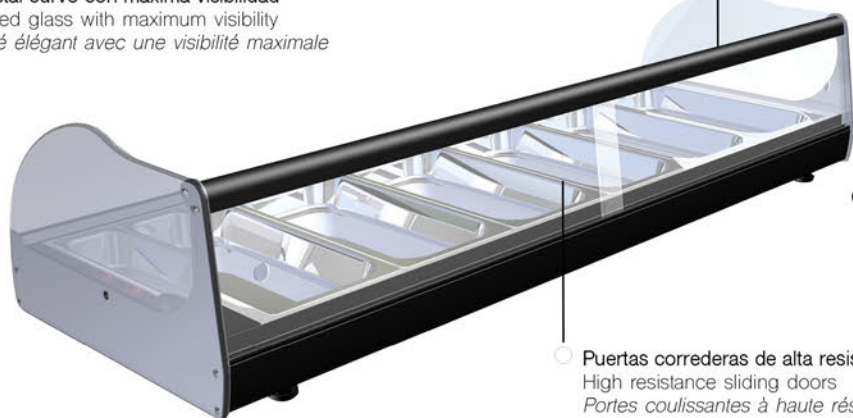

ONIX 6 HOT

Puertas correderas de alta resistencia
High resistance sliding doors
Portes coulissantes à haute résistance

AISLAMIENTO POLIURETANO INYECTADO DE 30 MM DE ESPESOR,
LIBRE DE CFC'S Y DENSIDAD DE 40 KG/M

INSULATED POLYURETHANE INSULATION OF 30 MM THICKNESS,
FREE OF CFC'S AND DENSITY OF 40 KG / M

ISOLANT ISOLÉ EN POLYURÉTHANE D'UNE ÉPAISSEUR DE 30 MM,
EXEMPT DE CFC ET D'UNE DENSITÉ DE 40 KG / M

FUNCIONAMIENTO CON AGUA
OPERATION WITH WATER
FONCTIONNEMENT AVEC DE L'EAU

CUBA AISI 304 SIN ANGULOS
CUBA AISI 304 WITHOUT CORNERS
CUVE AISI 304 SANS ANGLE

← 12 cm →



BAÑO MARÍA
WATER BATH
BAIN-MARIE

ACCESORIOS ACCESSORIES ACCESSOIRES

JUEGO SOPORTES VITRINA
SUPPORT SET FOR DISPLAY CASES
JEU DE SUPPORTS EN SALLE POUR VITRINE

NEW!

JUEGO PUERTAS EFECTO ESPEJO
SPECIAL MIRROR EFFECT DOORS
JEU DE PORTES VITRINES MIRROR

BANDEJAS COLORES
COLOR TRAYS
PLATEAUX COULEURS
NEW!

White Red Cristal Blue Inox

CALENTADOR TAPAS ONIX



VITRINAS CALIENTES CRISTAL DOBLE CURVA
HOT DISPLAY CASES DOUBLE CASES
VITRINES CHAUD DOUBLE COURBE



INDUSTRIA 90

ONIX 6 HOT

* Vitrinas Hot : con cable calefactor
* Calentadores : con resistencia

Modelo	Código	Dimensiones L x P x H (mm)	Potencia	Temperatura	Tensión	Capacidad	Peso	Precio
			w	°C	V			
ONIX 4 HOT BAÑO MARIA	306917	807X390X227	260	+30°C/+90°C	230	4XGN1/3x40	20	590
ONIX 6 HOT BAÑO MARIA	306934	1146X390X227	340	+30°C/+90°C	230	6XGN1/3x40	28	620
ONIX 8 HOT BAÑO MARIA	306935	1457X390X227	460	+30°C/+90°C	230	8XGN1/3x40	35	650
ONIX 4 CALENTADOR BAÑO MARIA	807098	807X390X227	260	+30°C/+90°C	230	4XGN1/3x40	20	590
ONIX 6 CALENTADOR BAÑO MARIA	807099	1146X390X227	340	+30°C/+90°C	230	6XGN1/3x40	28	620

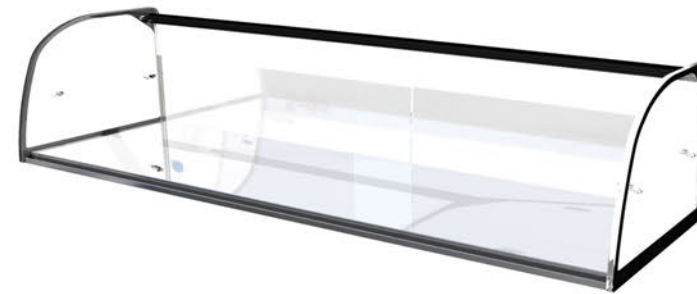

VITRINAS NEUTRAS
NEUTRAL DISPLAY CASES
VITRINES NEUTRES



CUB NEUTRA

CARACTERÍSTICAS CHARACTERISTICS CARACTÉRISTIQUES

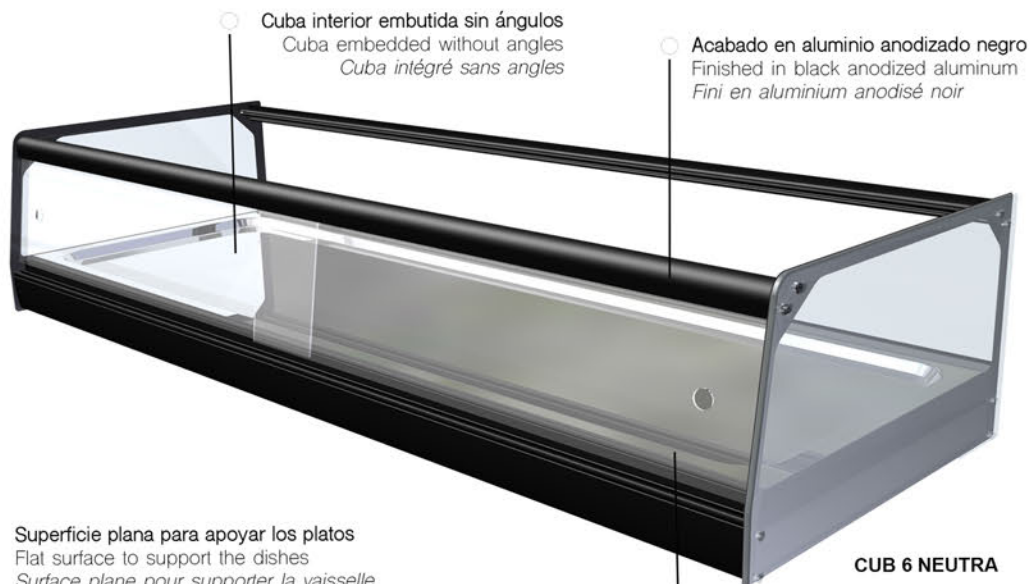

Superficie plana para apoyar los platos
Flat surface to support the dishes
Surface plane pour supporter la vaisselle

← 34 cm →

○ Puertas correderas de alta resistencia
High resistance sliding doors
Portes coulissantes à haute résistance



AISLAMIENTO POLIURETANO INYECTADO DE 30 MM DE ESPESOR ,
LIBRE DE CFC'S Y DENSIDAD DE 40 KG/M
INSULATED POLYURETHANE INSULATION OF 30 MM THICKNESS,
FREE OF CFC'S AND DENSITY OF 40 KG / M
*ISOLANT ISOLÉ EN POLYURÉTHANE D'UNE ÉPAISSEUR DE 30 MM,
EXEMPT DE CFC ET D'UNE DENSITÉ DE 40 KG / M*

○ Gran visibilidad del producto
Great visibility of the product
Grande visibilité du produit

CUB 4 NEUTRA

○ Cristal plano
Flat crystal
Cristal plat

ESCOJE TU LOGO
CHOOSE YOUR LOGO
CHOISISSEZ VOTRE LOGO

CUB NEUTRA



INDUSTRIA 90

VITRINAS NEUTRAS CRISTAL PLANO
NEUTRAL DISPLAY CASES STRAIGHT CRYSTAL
VITRINES NEUTRES VITRE PLAN



CUB 6 NEUTRA



CUB 8 NEUTRA

Modelo	Código	Dimensiones	Potencia	Temperatura	Tensión	Capacidad	Peso	Precio
		L x P x H (mm)	w	°C	V		Kg	euros
CUB 4 NEUTRA	307026	757X390X224	-	-	-	sin bandejas	15	543
CUB 6 NEUTRA	307027	1096X390X224	-	-	-	sin bandejas	23	593
CUB 8 NEUTRA	307028	1437X390X224	-	-	-	sin bandejas	30	638

EXPOSITORES

CARACTERÍSTICAS CHARACTERISTICS CARACTÉRISTIQUES



EXPOSITOR 2P PLANO

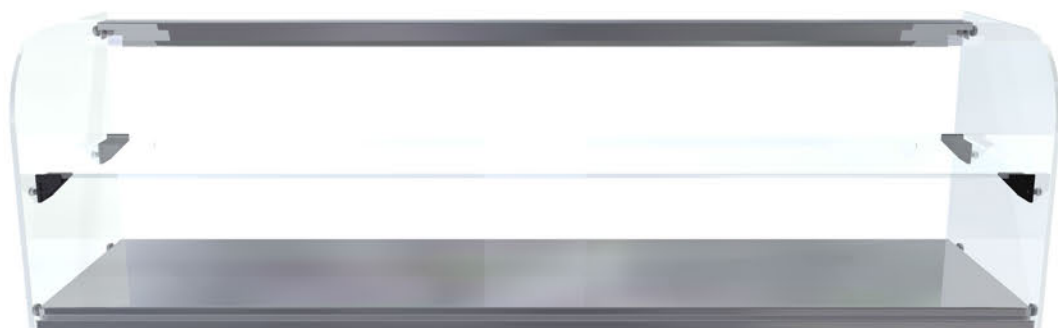

EXPOSITOR 2P CURVO



EXPOSITORES



INDUSTRIA 90

VITRINAS NEUTRAS CRISTAL PLANO/CURVO
NEUTRAL DISPLAY CASES STRAIGHT/CURVE CRYSTAL
VITRINES NEUTRES VITRE PLAN/COURBE



EXPOSITOR 1P PLANO



EXPOSITOR 1P CURVADO

Modelo	Código	Dimensiones	Capacidad	Peso	Precio
		L x P x H (mm)			
EXPOSITOR NEUTRO 1 PISO CURVADA	306550	1010X300X200	sin bandejas	6	209
EXPOSITOR NEUTRO 1 PISO PLANA	306551	1010X300X200	sin bandejas	6	178
EXPOSITOR NEUTRO 1 PISO PLANA 390	306543	1010X390X200	sin bandejas	8	267
EXPOSITOR NEUTRO 2 PISOS CURVADA	306552	1010X300X300	sin bandejas	7	242
EXPOSITOR NEUTRO 2 PISOS PLANA	306553	1010X300X300	sin bandejas	7	215
EXPOSITOR NEUTRO 2 PISOS PLANA 390	306544	1010X390X300	sin bandejas	9	323

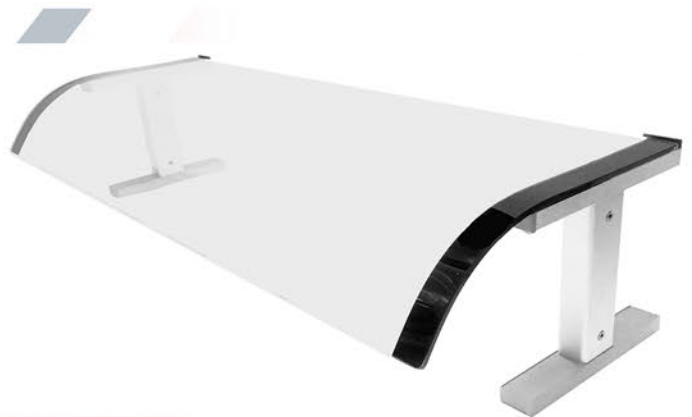
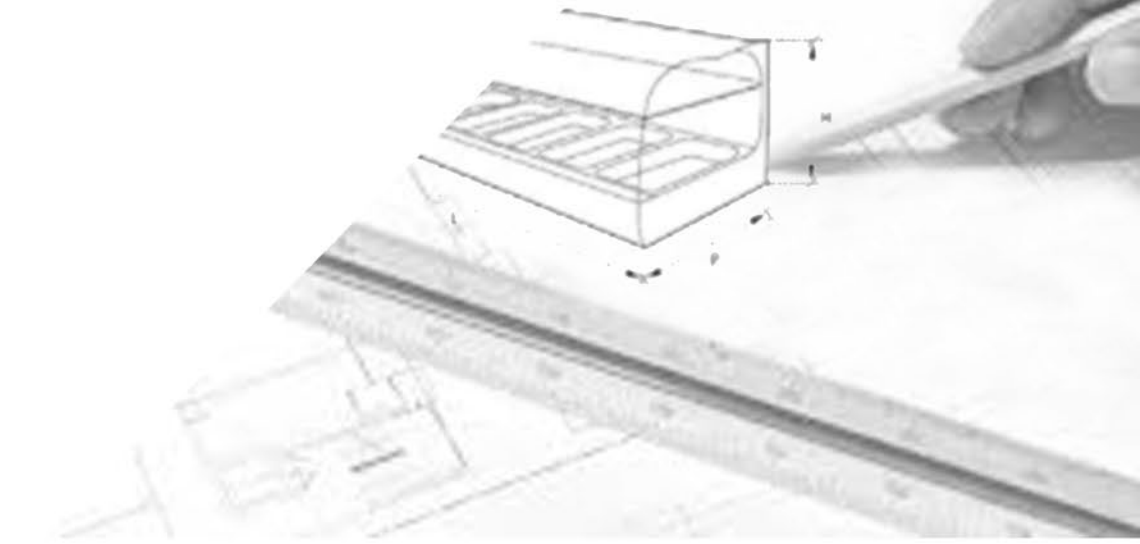

VITRINAS ESPECIALES
SPECIAL DISPLAY CASES
VITRINES SPÉCIALES

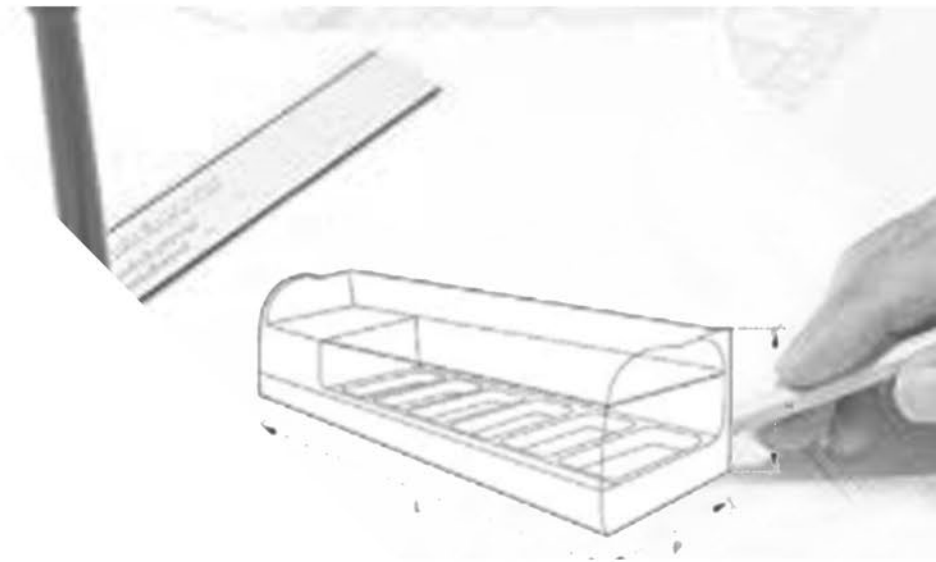
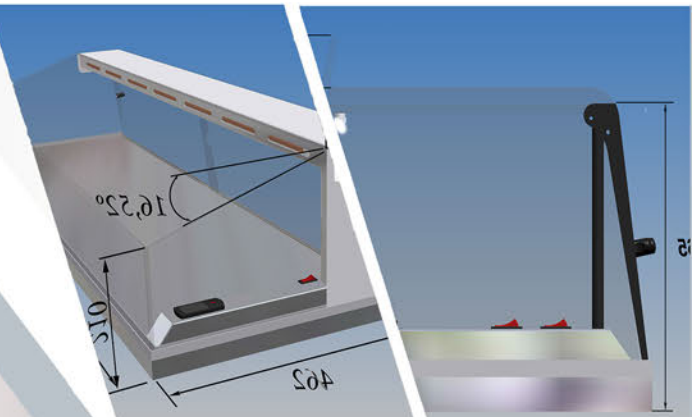

VITRINAS A MEDIDA

CARACTERÍSTICAS CHARACTERISTICS CARACTÉRISTIQUES



EXPOSITOR A MEDIDA

Fidelice a su cliente personalizando el producto



EXPOSITOR CON LUZ

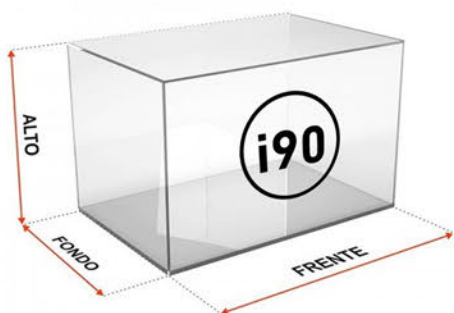

PLACA ENCASTAR CON BANDEJAS

VITRINAS ESPECIALES



INDUSTRIA 90

VITRINAS ESPECIALES Y A MEDIDA

SPECIAL DISPLAY CASES

VITRINES SPÉCIAUX



Código	Modelo	Dimensiones L x P x H (mm)	Peso kg	Precio €
A MEDIDA				

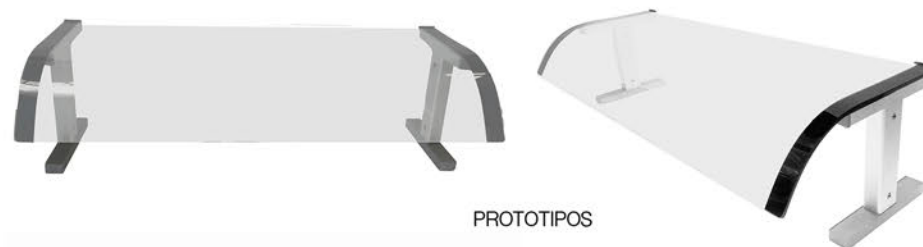
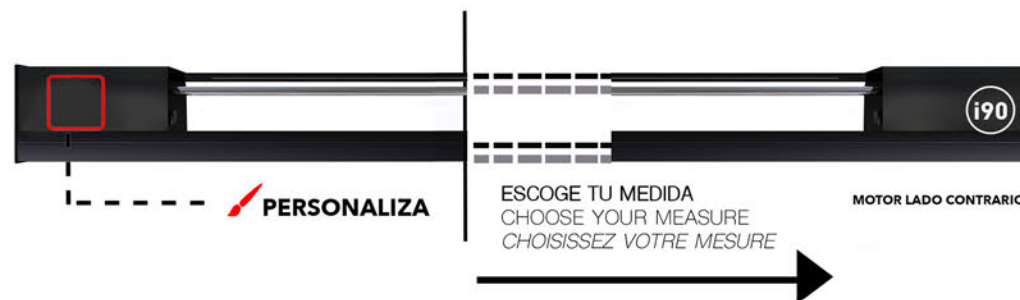

PROTOTIPOS

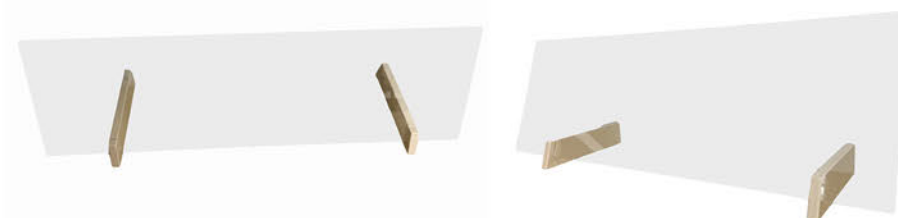

MINIMAL



PLANCHAS
GRIDDLES
PLAQUES



PLANCHAS



CARACTERÍSTICAS CHARACTERISTICS CARACTÉRISTIQUES



PREPARADA A GAS BUTANO , INCLUYE INYECTORES PARA GAS NATURAL
PREPARED FOR BUTANE GAS, INCLUDES INJECTORS FOR NATURAL GAS
PRÉPARÉ POUR LE GAZ BUTANE, COMPREND DES INJECTEURS POUR LE GAZ NATUREL

PLANCHAS



PLANCHAS ELÉCTRICAS
ELECTRIC GRIDDLES
PLAQUES ELECTRIQUES



Modelo	Código	Dimensiones L x P x H (mm)	Potencia	Temperatura	Tensión	Medidas placa	Peso	Precio
			kw	°C	V		Kg	euros
PLANCHA ELECTRICA PE40	203031	405X450X180	3	+80°C/300°C	230	400X400X6	15	307
PLANCHA ELECTRICA PE60	203032	605X450X180	3	+80°C/300°C	230	600X400X6	22	366

PLANCHAS



CARACTERÍSTICAS CHARACTERISTICS CARACTÉRISTIQUES

Placa de 6mm HIERRO IRON FER



Encimera de 6mm de espesor
Countertop 6mm thick
Plan de travail 6mm d'épaisseur

Peto para evitar salpicaduras
Bib to avoid splashing
Bavoir pour éviter les éclaboussures

Recoge grasas extraíble
Collect removable greases
Récupérer les graisses amovibles

Quemadores de alto rendimiento
High performance burners
Brûleurs haute performance

P 40 HIERRO

P 60 HIERRO

Placa de 14mm HIERRO RECTIFICADO RECTIFIED IRON FER RECTIFIÉ



Acabado Exterior Acero Inox
Stainless Steel Exterior Finish
Finition extérieure en acier inoxydable

Placa Rectificada de 14mm
14mm Rectified plate
Plaque rectifiée 14mm

Salida Torna Gas (posibilidad lado contrario)
Gas outlet
Sortie de gaz

P 45 HIERRO

Patas regulables en altura
Adjustable legs height
Jambes réglables en hauteur

P 65 CROMO

Recoge grasas frontal
Frontal collect fats
Recueillir les graisses avant

P 85 CROMO

Placa de 12mm

CROMO CHROME CHROME

LA INSTALACIÓN DEBE HACERSE CON UN REGULADOR DE 30GR PARA GAS BUTANO/PROPANO Y DE 50 GR PARA GAS NATURAL
THE INSTALLATION MUST BE DONE WITH A 30 GR REGULATOR FOR BUTANE / PROPANE GAS AND 50 GR FOR NATURAL GAS
L'INSTALLATION DOIT ÊTRE RÉALISÉE AVEC UN RÉGULATEUR DE 30 GR POUR LE GAZ DE BUTANE / PROPANE ET 50 GR POUR LE GAZ NATUREL



PALASTRO CROMADO DE 12MM
12MM CHROMED PALLET
PALETTE CHROMÉE DE 12MM

CROMO DURO DE 60 MICRAS
HARD CHROME 60 MICRONS
CHROME DUR 60 MICRONS

Patas regulables en altura
Adjustable legs height
Jambes réglables en hauteur

P45 CROMO

P 65 CROMO

Regulación Temperatura manual
Manual temperature regulation
Régulation manuelle de la température

Acabado Exterior Acero Inox
Stainless Steel Exterior Finish
Finition extérieure en acier inoxydable

Recoge grasas frontal
Frontal collect fats
Recueillir les graisses avant

P 85 CROMO

PLANCHAS



PLANCHAS GAS GAS GRIDDLES PLAQUES À GAZ



PLANCHA 80 HIERRO

Modelo	Código	Dimensiones L x P x H (mm)	Potencia		nº Válvulas V	Medidas placa	Peso Kg	Precio euros
			kw	Kcal/h				
PLANCHA 40 HIERRO 6MM	203037	448X462X255	2,9	3190	1	400X400	12	312
PLANCHA 60 HIERRO 6MM	203035	648X462X255	5,8	6381	2	600X400	23,5	358
PLANCHA 80 HIERRO 6MM	203036	848X462X255	8,7	9571	3	800X400	34	436
PLANCHA 45 HIERRO 14MM	203053	465X430X260	4,5	4950	1	444X395	15	631
PLANCHA 65 HIERRO 14MM	203054	665X430X260	7	7701	2	644X395	27	693
PLANCHA 85 HIERRO 14MM	203055	865X430X260	9	9901	2	844X395	37	909
PLANCHA 45 CROMO12MM	203062	400X430X220	4,5	4950	1	444X395	19	857
PLANCHA 65 CROMO12MM	203063	600X430X220	7	7701	2	644X395	30	1042
PLANCHA 85 CROMO 12MM	203064	800X430X220	9	9901	2	844X395	41	1204
PLANCHA 40+FOGON	203029	800X460X280	3,2+6	1012,1012	2	400+400	26	684
PLANCHA 60+FOGON	203038	100X460X280	6,4+6	1364,1364	3	600+400	31	805
PLANCHA 80+FOGON	203039	1200X460X280	9,6+6	1672,1672	4	800+400	46	925



COCINAS
KITCHENS
CUISINES



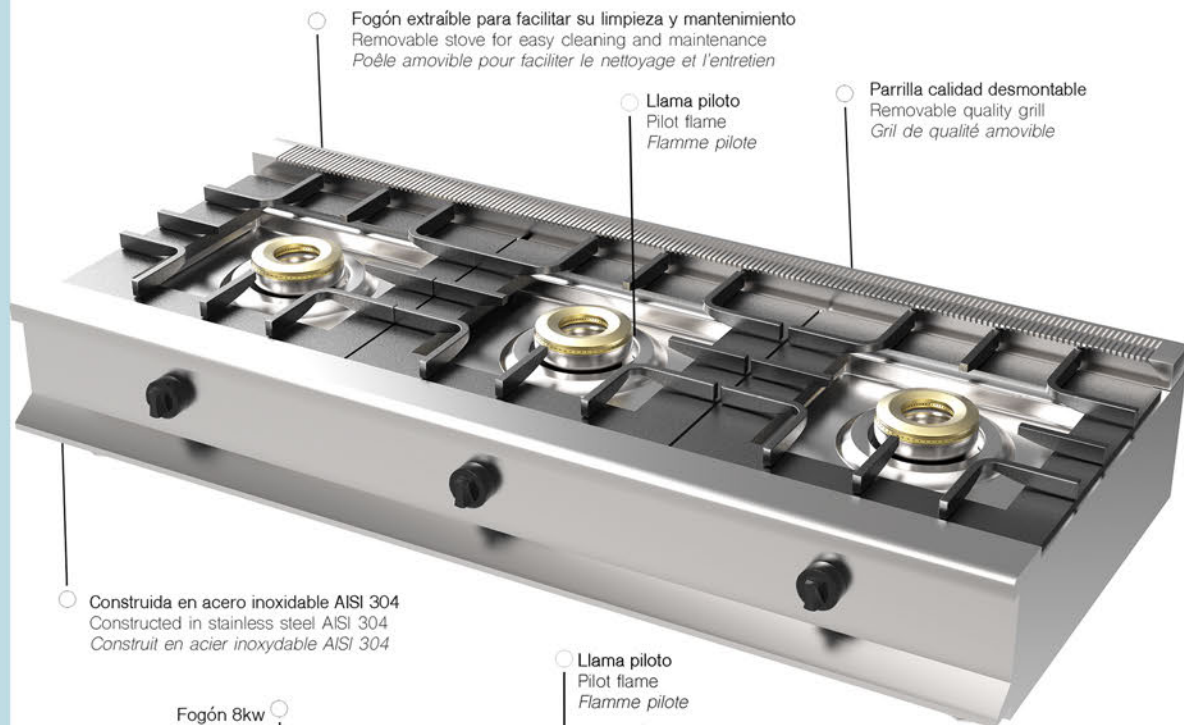

Fogón extraíble para facilitar su limpieza y mantenimiento
Removable stove for easy cleaning and maintenance
Poêle amovible pour faciliter le nettoyage et l'entretien

Llama piloto
Pilot flame
Flamme pilote

Parrilla calidad desmontable
Removable quality grill
Gril de qualité amovible

Construida en acero inoxidable AISI 304
Constructed in stainless steel AISI 304
Construit en acier inoxydable AISI 304

Llama piloto
Pilot flame
Flamme pilote

Fogón 8kw
Stove 8k
Poêle 8kw

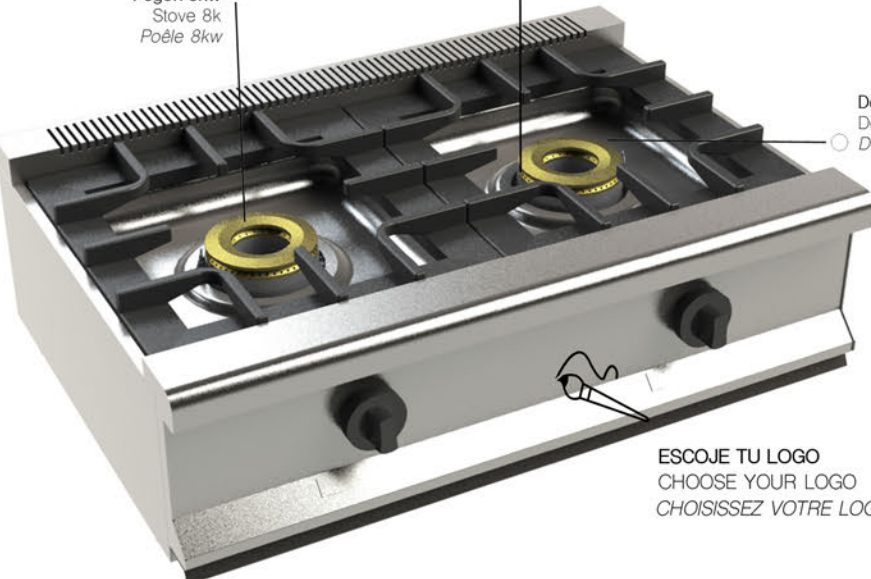

Doble corona de latón
Double brass crown
Double couronne en laiton

PF2

PF3

ESCOJE TU LOGO
CHOOSE YOUR LOGO
CHOISISSEZ VOTRE LOGO



COCINA 2 FUEGOS CON HORNO

Preparadas para gas butano-propano, con juego de inyectores de recambio para gas natural
Prepared for butane-propane gas, with set of replacement injectors for natural gas
Préparé pour le gaz butane-propane, avec jeu d'injecteurs de remplacement pour le gaz naturel

Modelo	Código	Dimensiones L x P x H (mm)	Potencia		nº Válvulas V	Peso Kg	Precio euros
			kw	Kcal/h			
COCINA ECO 1 FUEGO	203079	400X460X240	6	660	1	12	446
COCINA ECO 2 FUEGOS	203080	800X460X240	12	1320	2	24	782
COCINA ECO 3 FUEGOS	203081	1200X460X240	18	1980	3	36	1159
COCINA 2 FUEGOS SOBREMESA PF2	203043	800X550X290	16	1760	2	14	1100
COCINA 3 FUEGOS SOBREMESA PF3	203044	1200X550X290	24	2640	3	20	1372
COCINA 2 FUEGOS CON HORNO PFH2	203045	800X550X850	18,5 (16+2,5)	2035	2+1	18	1962
COCINA 3 FUEGOS CON HORNO PFH3	203046	1200X550X850	26,5(24+2,5)	2915	3+1	24	2304

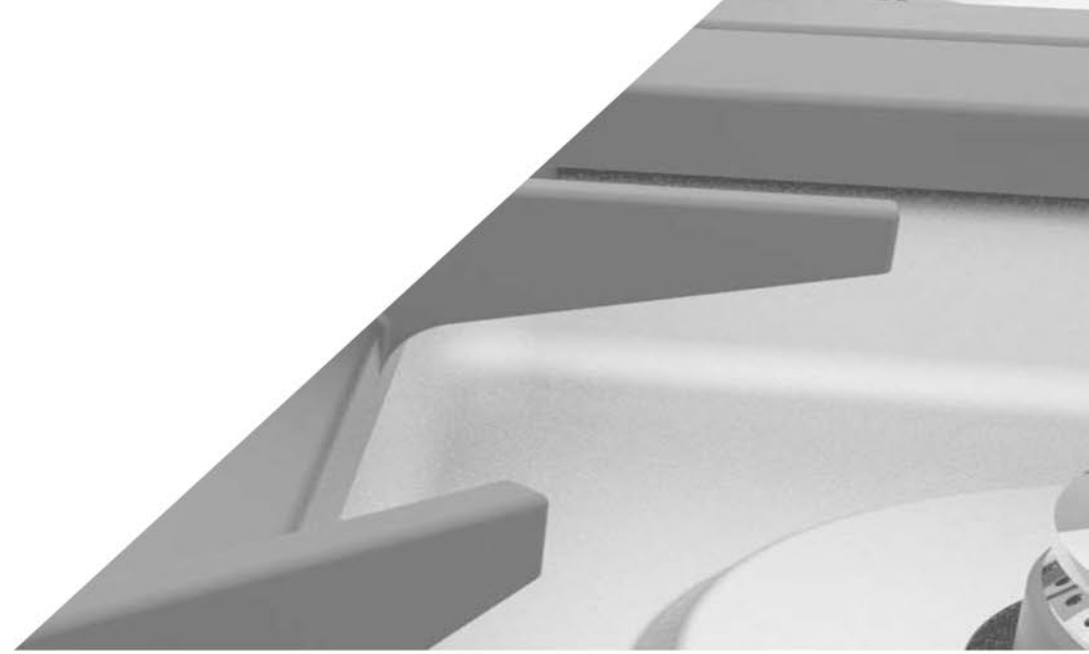

SERIE 550
SERIE 550
SERIE 550

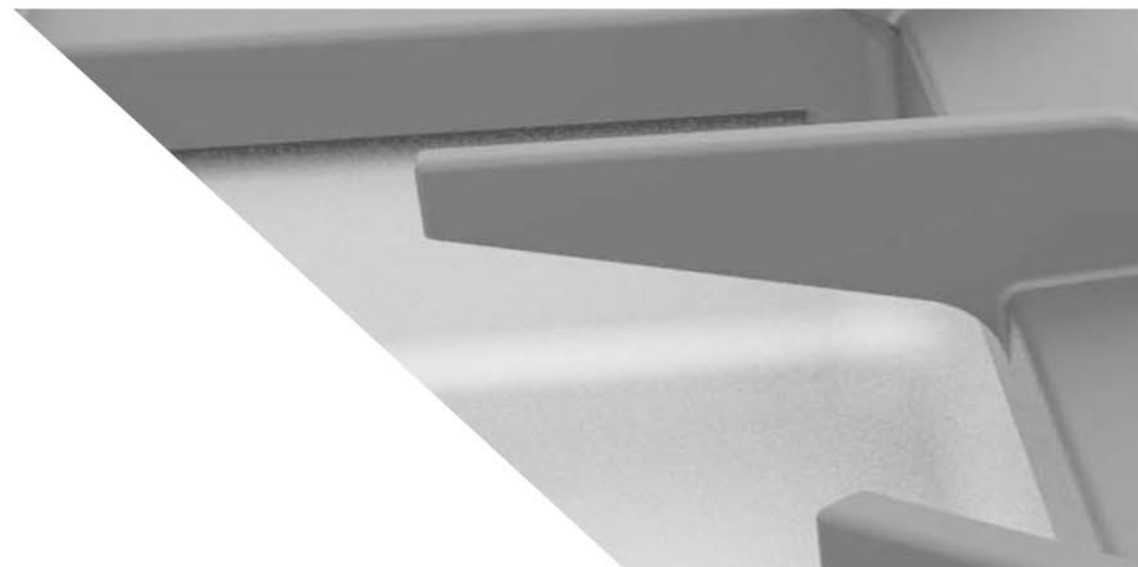

NEW serie 550

CARACTERÍSTICAS CHARACTERISTICS CARACTÉRISTIQUES



ACCESORIOS ACCESSORIES ACCESSOIRES



CONSTRUIDA TOTALMENTE EN ACERO INOXIDABLE AISI 304 (18/10)
 TOTALLY BUILT IN STAINLESS STEEL AISI 304 (18/10)
 TOTALEMENT CONSTRUIT EN ACIER INOXYDABLE AISI 304 (18/10)



Cabezal eléctrico extraíble fácil limpieza
 Removable electric head - easy clean
 Tête électrique amovible-nettoyage facile



Cesta acero AISI 304 reforzada
 Reinforced steel AISI 304 basket
 Panier en acier renforcé

FONDO 550
 FUND 550
 FONDS 550

NEW serie 550 freidora

LINEA PREMIUM
 PREMIUM LINE
 LIGNE PREMIUM



Modelo	Código	Dimensiones	Potencia	Voltaje	Capacidad	Cesta	Raciones	Peso	Precio
		L x P x H (mm)	Kw	V	L	L x P x H (mm)	200g	Kg	euros
FASM10 230	157513	330X550X390	4	230	10	185X245X110	91	17	825

NEW

serie 550

CARACTERÍSTICAS CHARACTERISTICS CARACTÉRISTIQUES



Acabado exterioro acero inoxidable
External finish stainless steel
Finition extérieure en acier inoxydable

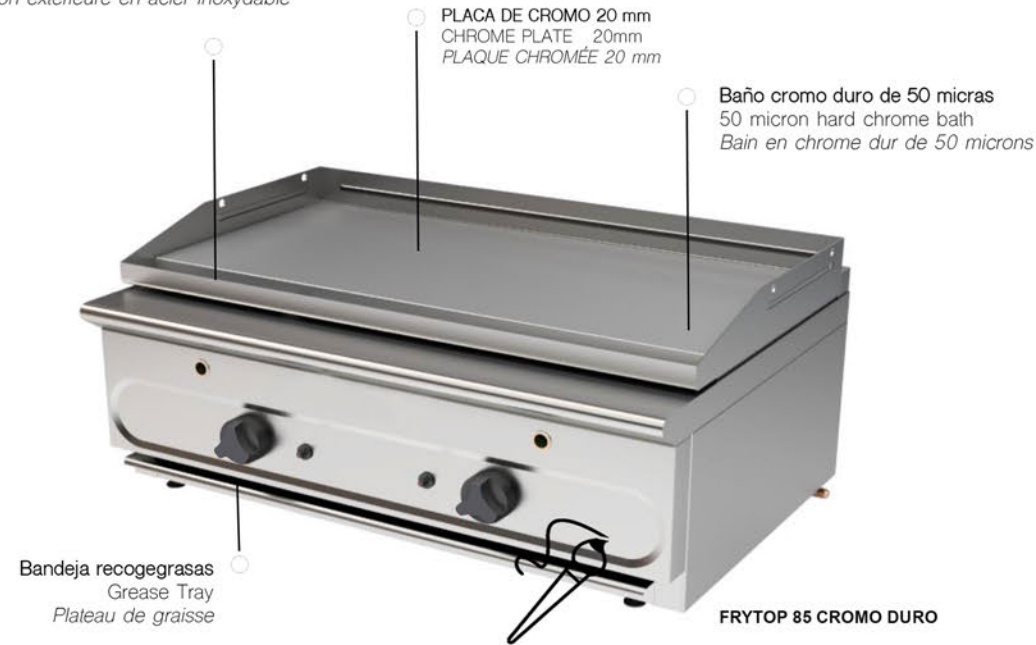

NEW

serie 550 frytop

LINEA PREMIUM
PREMIUM LINE
LIGNE PREMIUM



Modelo	Código	Dimensiones L x P x H (mm)	Potencia		nº Válvulas	Medidas placa	Peso		Precio
			kw	Kcal/h			V	Kg	
FRYTOP 45 HIERRO 20MM	203065	450X550X290	6,5	7151	1	444X395	15	919	
FRYTOP 65 HIERRO 20MM	203066	650X550X290	9,75	10726	2	644X395	27	1324	
FRYTOP 85 HIERRO 20MM	203067	850X550X290	13	14301	2	844X395	37	1678	
FRYTOP 45 CROMO DURO 20MM	203068	450X550X290	6,5	7151	1	444X395	19	1478	
FRYTOP 65 CROMO DURO 20MM	203069	650X550X290	9,75	10726	2	644X395	30	2167	
FRYTOP 85 HIERRO DURO 20MM	203070	850X550X290	13	14301	2	844X395	41	2793	

NEW

serie 550

CARACTERÍSTICAS CHARACTERISTICS CARACTÉRISTIQUES



FUEGOS ABIERTOS CON LLAMA PILOTO
OPEN FIRES WITH PILOT FLAME
FEUX OUVERTS AVEC FLAMME PILOTE

ESCOJE TU LOGO
CHOOSE YOUR LOGO
CHOISISSEZ VOTRE LOGO



COCINA 2F CON HORNO

Patas de acero Inox regulables en altura
Stainless steel legs adjustable in height
Pieds en acier inoxydable réglables en hauteur



COCINA 3F CON HORNO

LA INSTALACIÓN DEBE HACERSE CON UN REGULADOR DE 30GR PARA GAS BUTANO/PROPANO Y 50gr PARA GAS NATURAL
THE INSTALLATION MUST BE DONE WITH A 30GR REGULATOR FOR BUTANE / PROPANE GAS AND 50gr FOR NATURAL GAS
L'INSTALLATION DOIT ÊTRE FAITE AVEC UN RÉGULATEUR 30GR POUR LE GAZ DE BUTANE / PROPANE ET 50 GR POUR LE GAZ NATUREL



COCINA 2 FUEGOS SOBREMESA

Acabado exterior Acer Inoxidable
External finish Acer Stainless
Finition extérieure Acer Stainless



Parrillas esmaltadas
Glazed grills
Grils vitrés

ESCOJE TU LOGO
CHOOSE YOUR LOGO
CHOISISSEZ VOTRE LOGO

COCINA 3 FUEGOS SOBREMESA



COCINA 1 FUEGO SOBREMESA

Bandeja recoge grasas
Grease tray
Bac à graisse

VÁLVULA TERMOPAR DE SEGURIDAD
THERMOPARD SECURITY VALVE
SOUPAPE DE SECURITE THERMOPARD

NEW

serie 550 cocinas

LINEA PREMIUM
PREMIUM LINE
LIGNE PREMIUM



COCINA 2 FUEGOS SOBREMESA

Modelo	Código	Dimensiones L x P x H (mm)	Potencia		nº Válvulas V	Peso Kg	Precio euros
			kw	Kcal/h			
COCINA 1 FUEGO SOBREMESA S550	203071	455X550X290	7,5	825	1	9	677
COCINA 2 FUEGOS SOBREMESA S550	203072	800X550X290	7,5+5	1375	2	14	1198
COCINA 3 FUEGOS SOBREMESA S550	203073	1200X550X290	7,5+5+5	1925	3	20	1212
COCINA 2 FUEGOS CON HORNO S550	203074	800X550X850	7,5+5+4,9	1914	2+1	25	2047
COCINA 3 FUEGOS CON HORNO S550	203075	800X550X320	7,5+5+5+4,9	2464	3+1	29	2431

NEW

serie 550

CARACTERÍSTICAS CHARACTERISTICS CARACTÉRISTIQUES



PIEDRA VOLCÁNICA INCLUIDA
VOLCANIC STONE INCLUDED
PIERRE VOLCANIQUE INCLUSE

NEW

serie 550 barbacoa

LINEA PREMIUM
PREMIUM LINE
LIGNE PREMIUM



BR 65

Modelo	Código	Dimensiones L x P x H (mm)	Potencia		n° Válvulas	Peso Kg	Precio euros
			kw	Kcal/h			
BARBACOA B5	203083	370X600X260	7,2	792	1	25	687
BARBACOA B10	203084	600X600X260	14,4	1584	2	39	945
BARBACOA B15	203085	900X600X260	21,6	2376	3	58	1305
BARBACOA B45	203086	450X550X290	6,5	715	1	19	1192
BARBACOA B65	203087	650X550X290	9,75	1073	2	30	1565
BARBACOA B85	203088	850X550X290	13	1430	2	41	2118



SERIE 700
SERIES 700
SÉRIE 700



NEW

serie 700

CARACTERÍSTICAS CHARACTERISTICS CARACTÉRISTIQUES



Termostato trabajo regulable
Adjustable work thermostat
Thermostat de travail réglable

Cuba sin ángulos
Cuba without angles
Cuba sans angles

ESCOJE TU LOGO
CHOOSE YOUR LOGO
CHOISISSEZ VOTRE LOGO

Cabezal eléctrico extraíble fácil limpieza
Removable electric head - easy clean
Tête électrique amovible-nettoyage facile

Tapa
cap
Casquette

FASM 17 400

CONSTRUIDA TOTALMENTE EN ACERO INOXIDABLE AISI 304 (18/10)
TOTALLY BUILT IN STAINLESS STEEL AISI 304 (18/10)
TOTALEMENT CONSTRUIT EN ACIER INOXYDABLE AISI 304 (18/10)



Cesta acero AISI 304 reforzada
Reinforced steel AISI 304 basket
Panier en acier renforcé

Patas regulables antideslizantes
Adjustable anti-slip feet
Pieds antidérapants réglables



FASM 17 230

FONDO 700
FUND 700
FONDS 700

ACCESORIOS ACCESSORIES ACCESSOIRES



CONTROLADOR TIEMPO FRITURA
CHECK FRIT TIME
CONTRÔLEUR DE TEMPS DE FRITTER



MEDIDOR CALIDAD ACEITE
OIL QUALITY METER
COMPTEUR DE QUALITE D'HUILE

NEW

serie 700 freidora

LINEA PREMIUM
PREMIUM LINE
LIGNE PREMIUM



FASM 17 + 17 400

FREIDORAS ACEITE

Modelo	Código	Dimensiones	Potencia	Voltaje	Capacidad	Cesta	Raciones	Peso	Precio
		L x P x H (mm)	Kw	V	L	L x P x H (mm)	200g	Kg	euros
FASM17 230	157514	400X700X940	6	230	17	208X285X120	110	30	1750
FASM17+17 230	157515	800X700X940	6+6	230	17+17	208X285X120	220	55	3361
FASM17 400	157516	400X700X940	7	400	17	208X285X120	110	30	1802
FASM17+17 400	157517	800X700X940	7+7	400	17+17	208X285X120	220	55	3458

FREIDORAS AGUA - ACEITE

Modelo	Código	Dimensiones	Potencia	Voltaje	Capacidad			Cesta	Raciones	Peso	Precio
		L x P x H (mm)	Kw	V	Agua(L)	Aceite(L)	Total(L)	L x P x H (mm)	200g	Kg	euros
FSM17 230	107325	400X700X940	6	230	4,5	15	19,5	208X285X120	110	30	1847
FSM17+17 230	107326	800X700X940	6+6	230	4,5+4,5	15+15	19,5+19,5	208X285X120	220	55	3491
FSM17 400	107327	400X700X940	7	400	4,5	15	19,5	208X285X120	110	30	1902
FSM17+17 400	107328	800X700X940	7+7	400	4,5	15	19,5	208X285X120	220	55	3594



CARACTERÍSTICAS CHARACTERISTICS CARACTÉRISTIQUES

LINEA PREMIUM
PREMIUM LINE
LIGNE PREMIUMPREPARADAS CON GAS BUTANO -PROPANO
PREPARED WITH BUTANE GAS -PROPANE
PRÉPARE AVEC GAZ DE BUTANE -PROPANEEQUIPADOS CON PILOTO Y VÁLVULA DE SEGURIDAD
EQUIPPED WITH PILOT AND SAFETY VALVE
ÉQUIPÉ DE PILOTE ET DE SOUPAPE DE SÉCURITÉLlama piloto
Pilot flame
Flamme piloteQUEMADORES ABIERTOS DE 8KW
OPEN BURNERS OF 8KW
BRÛLEURS OUVERTS DE 8KWPies regulables
Adjustable height
Hauteur réglableESCOJE TU LOGO
CHOOSE YOUR LOGO
CHOISISSEZ VOTRE LOGO

COCINA 4 F SOBREMESA

Con parrilla de hierro fundido
With cast iron grill
Avec grille en fonteLlama piloto
Pilot flame
Flamme pilote

COCINA 2F SOBREMESA

CONTRUIDAS DE ACERO INOXIDABLE AISI304
STAINLESS STEEL CONTRIBUTIONS AISI304
CONTRIBUTIONS EN ACIER INOXYDABLE AISI304ESCOJE TU LOGO
CHOOSE YOUR LOGO
CHOISISSEZ VOTRE LOGO

COCINA 4F CON HORNO

Modelo	Código	Dimensiones L x P x H (mm)	Potencia		nº Válvulas	Peso Kg	Precio euros
			kw	Kcal/h			
COCINA 2 FUEGOS SOBREMESA S700	203076	400X700X320	8+8	1760	2	29	1117
COCINA 4 FUEGOS SOBREMESA S700	203077	800X700X320	8+8+8+8	3520	4	49	1569
COCINA 4 FUEGOS+HORNO S700	203078	800X700X850	8+8+8+8 H2,5	3795	4+1	80	2772



TERMOS
THERMOS
THERMOS



TERMOS

CARACTERÍSTICAS CHARACTERISTICS CARACTÉRISTIQUES

Regulación automática de temperatura
Automatic temperature regulation
Régulation automatique de la température



Grifo regulable dos posiciones
Grifo regulable dos posiciones
Robinet réglable deux positions



Depósito desmontable mediante rosca
Removable tank with thread
Réservoir amovible avec fil

ESCOJE TU LOGO
CHOOSE YOUR LOGO
CHOISISSEZ VOTRE LOGO

CONSTRUIDO EN ACERO INOXIDABLE
BUILT IN STAINLESS STEEL
CONSTRUIT EN ACIER INOXYDABLE

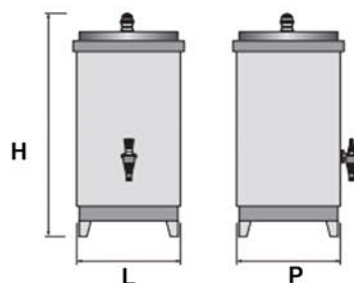

CALEFACCIÓN ELÉCTRICA MEDIANTE RESISTENCIA
ELECTRICAL HEATING THROUGH RESISTANCE
CHAUFFAGE ELECTRIQUE PAR RESISTANCE

TERMOS

TERMOS
THERMOS
THERMOS



TERMO 6



TERMO 6+6

Modelo	Código	Dimensiones L x P x H (mm)	Potencia kw	Tensión V	Capacidad L	Peso Kg	Precio euros
TERMO 3 LITROS	440050	232x232x430	1	230	3	7	514
TERMO 6 LITROS	440051	265x265x525	1,5	230	6	10	553
TERMO 12 (6+6) LITROS	440052	525x265x525	1,5+1,5	230	6+6	20	965
TERMO 20 LITROS	440053	380x380x600	3	230	20	15	965



VARIOS
VARIOUS
DIVERS

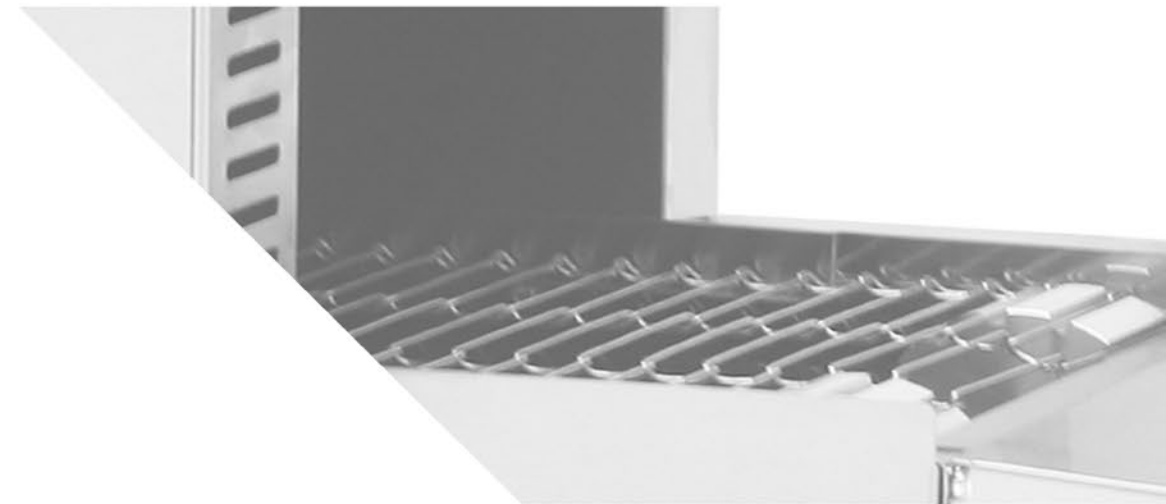

TOSTADORES



TOSTADORES DE CINTA
TAPE TOASTER
TASSE TOASTER



TC7



TC9

Modelo	Código	Dimensiones L x P x H (mm)	Potencia kw	Carga mm	Soporte mm	Tensión V	Produccion h	Precio euros
TOSTADOR DE CINTA TC7	44005	760X310X334	3,3	100	150+150	230	745/780	1568
TOSTADOR DE CINTA TC9	44006	920X520X350	6,6	52 a 100	200+340	230	1260/1300	2886

MICROONDAS



MICROONDAS
MICROWAVE OVEN
MICRO-ONDES



FM1800 4 MAGNETRONES



FM2100 2 MAGNETRONES



900 INOX

Modelo	Código	Dimen.Exteriores L x P x H (mm)	Potencia kw	Grill kw	Temporizador m	Descongelacion	Tensión V	Peso Kg	Precio euros
900 INOX	402026	483X398X281	1+0,9	0,9	30	SI	230	15,5	193

Modelo	Código	Dimen.Exteriores L x P x H (mm)	Dimen.Interiores L x P x H (mm)	Capacidad L	Potencia w	Magnetrones w	Tensión V	Peso Kg	Precio euros
FM-2100 2 MAGNETRONES	402010	422x508x337	330x310x175	18	2100	2x1050	230	30	2740
FM-1800 4 MAGNETRONES	402011	650x526x471	535x330x250	44	1800	4x450	230	54	4491
FM-2100 4 MAGNETRONES	402012	650x526x471	535x330x251	44	2100	4x525	400+N	54	4812
FM-3200 4 MAGNETRONES	402013	650x526x471	535x330x252	44	3200	4x800	400+N	65	5915



DOMÉSTICO
DOMESTIC
DOMESTIQUE



LUX 5

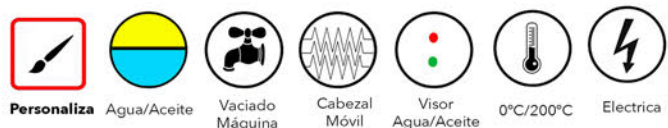

CARACTERÍSTICAS CHARACTERISTICS CARACTÉRISTIQUES

SISTEMA AGUA ACEITE WATER OIL SYSTEM SYSTÈME D'EAU ET D'HUILE

Cabezal eléctrico extraíble para su limpieza
Removable electric head for cleaning
Tête électrique amovible pour le nettoyage



DISPONIBLE CON CESTA DE RESIDUOS
AVAILABLE WITH WASTE BASKET
DISPONIBLE AVEC PANIER À DÉCHETS

ESCOJE TU LOGO
CHOOSE YOUR LOGO
CHOISISSEZ VOTRE LOGO



Termostato de Seguridad
Security Thermostat
Thermostat de sécurité

Termostato de trabajo hasta 200°C
Working thermostat up to 200°C
Thermostat de travail jusqu'à 200°C



RESISTENCIA ACERO INOXIDABLE
STAINLESS STEEL RESISTANCE
RÉSISTANCE À L'ACIER INOXYDABLE



Patas antideslizantes
Anti-slip feet
Pieds antidérapants

Sistema de elevación
Elevation system
Système de levage



CESTA REFORZADA EN MALLA Y VARILLA EN ACERO INOX
REINFORCED BASKET IN MESH AND ROD IN STAINLESS STEEL
PANIER RENFORCÉ EN MAILLE ET TIGE EN ACIER INOXYDABLE



Grifo para evacuar el aceite
Tap to evacuate the oil
Appuyez sur pour évacuer l'huile

LUX 5

FREIDORA DOMÉSTICA SISTEMA AGUA Y ACEITE DOMESTIC FRYER WATER OIL SYSTEM FRITEUSE D'EAU ET D'HUILE



Modelo	Código	Dimensiones	Potencia	Voltaje	Temperatura	Capacidad			Cesta	Raciones	Peso	Precio
		L x P x H (mm)	Kw	V	°C	Agua(L)	Aceite(L)	Total(L)	L x P x H (mm)	200g	Kg	euros
FREIDORA LUX 5	117054	320X270X280	2	230	200	1	4	5	RED.200X80	25	5,5	283
FREIDORA LUX 5 CON FILTRO	117055	320X270X280	2	230	200	1	4	5	RED.200X80	25	5,5	324

NEW

LUX 3



Personaliza



Aceite



Vaciado Máquina



Cabezal Fijo



0°C/200°C



Electrica 230/400 V

CARACTERÍSTICAS CHARACTERISTICS CARACTÉRISTIQUES



Cabezal eléctrico extraíble para su limpieza
Removable electric head for cleaning
Tête électrique amovible pour le nettoyage

RESISTENCIA BLINDADA
ARMORED RESISTANCE
RÉSISTANCE BLINDÉE

ESCOJE TU LOGO
CHOOSE YOUR LOGO
CHOISISSEZ VOTRE LOGO

Patas regulables
Adjustable legs
Jambes réglables

Temperatura regulable hasta los 200°C
Adjustable temperature up to 200°C
Température réglable jusqu'à 200°C

Sistema de elevación
Elevation system
Système de levage

CESTA REFORZADA EN MALLA Y VARILLA EN ACERO INOX
REINFORCED BASKET IN MESH AND ROD IN STAINLESS STEEL
PANIER RENFORCÉ EN MAILLE ET TIGE EN ACIER INOXYDABLE



Termostato Seguridad
Safety thermostat
Thermostat de sécurité



Disponible con cesta de residuos
Available with waste basket
Disponible avec corbeille

NEW

LUX 3

FREIDORA DOMÉSTICA ACEITE DOMESTIC OIL FRYER FRITEUSE À L'HUILE



INDUSTRIA 90



Modelo	Código	Dimensiones	Potencia	Voltaje	Temperatura	Capacidad			Cesta	Raciones	Peso	Precio
		L x P x H (mm)	Kw	V	°C	Agua(L)	Aceite(L)	Total(L)	L x P x H (mm)	200g	Kg	euros
FREIDORA LUX 3	117052	325X280X300	2	230	200	--	3	3	RED.200X80	25	4	283
FREIDORA LUX 3 CON FILTRO	117053	325X280X300	2	230	200	--	3	3	RED.200X80	25	4	324

PE 500 LUX



Personaliza 0°C/300°C Eléctrica

CARACTERÍSTICAS CHARACTERISTICS CARACTÉRISTIQUES

Peto perimetral 36mm (evita salpicaduras)
36mm perimeter bib (prevents splashing)
Bavette périmétrique de 36 mm (empêche les éclaboussures)

Placa acero laminado 5mm de grosor
Plate laminated steel 5mm thick
Plaque en acier laminé de 5mm d'épaisseur

ESCOJE TU LOGO
CHOOSE YOUR LOGO
CHOISISSEZ VOTRE LOGO

Recoge grasas desmontable
Collect detachable fats
Collecter les graisses détachables

Temperatura regulable hasta los 300°C
Adjustable temperature up to 300°C
Température réglable jusqu'à 300°C

Tratamiento especial antiadherente alimentario
Special non-stick food treatment
Traitement spécial antiadhésif



Asas desmontables
Removable handles
Poignées amovibles

Construido en acero inoxidable AISI 304 (18/10)
Constructed in stainless steel AISI 304 (18/10)
Construit en acier inoxydable AISI 304 (18/10)

CALENTAMIENTO POR RESISTENCIAS BLINDADAS
HEATING FOR ARMORED RESISTORS
CHAUFFAGE POUR RESISTANCES BLINDÉES

Patas regulables
Adjustable legs
Jambes réglables

PE 500 LUX



PLANCHA DOMÉSTICA ELÉCTRICA DOMESTIC ELECTRIC GRIDDLE PLAQUE ELECTRIQUE DOMESTIQUE



Modelo	Código	Dimensiones	Potencia	Voltaje	Temperatura	Capacidad			Placa	Raciones	Peso	Precio
		L x P x H (mm)	Kw	V	°C	Agua(L)	Aceite(L)	Total(L)	L x P x H (mm)	200g	Kg	euros
PLANCHA PE 500 LUX	203030	550X315X150	2,5	230	300	--	--	--	450x300	--	11	255

NEW

PE 300 LUX



Personaliza



0°C/300°C



Electrica

CARACTERÍSTICAS CHARACTERISTICS CARACTÉRISTIQUES



Placa acero laminado 5mm de grosor
Plate laminated steel 5mm thick
Plaque en acier laminé de 5mm d'épaisseur



NEW!

Tratamiento especial antiadherente alimentario
Special non-stick food treatment
Traitement spécial antiadhésif

Temperatura regulable hasta los 300°C
Adjustable temperature up to 300°C
Température réglable jusqu'à 300°C

Peto perimetral 36mm (evita salpicaduras)
36mm perimeter bib (prevents splashing)
Bavette périmétrique de 36 mm (empêche les éclaboussures)



CALENTAMIENTO POR RESISTENCIAS BLINDADAS
HEATING FOR ARMORED RESISTORS
CHAUFFAGE POUR RESISTANCES BLINDÉES



Recoge grasas desmontable
Collect detachable fats
Collecter les graisses détachables

Patas regulables
Adjustable legs
Jambes réglables

NEW

PE 300 LUX

PLANCHA DOMÉSTICA ELÉCTRICA
DOMESTIC ELECTRIC GRIDDLE
PLAQUE ELECTRIQUE DOMESTIQUE



INDUSTRIA 90



Modelo	Código	Dimensiones L x P x H (mm)	Potencia Kw	Voltaje V	Temperatura °C	Capacidad			Placa L x P x H (mm)	Raciones 200g	Peso Kg	Precio euros
						Agua(L)	Aceite(L)	Total(L)				
PLANCHA PE 300 LUX	203025	250X400X110	2,5	230	300	--	--	--	230X380	--		255

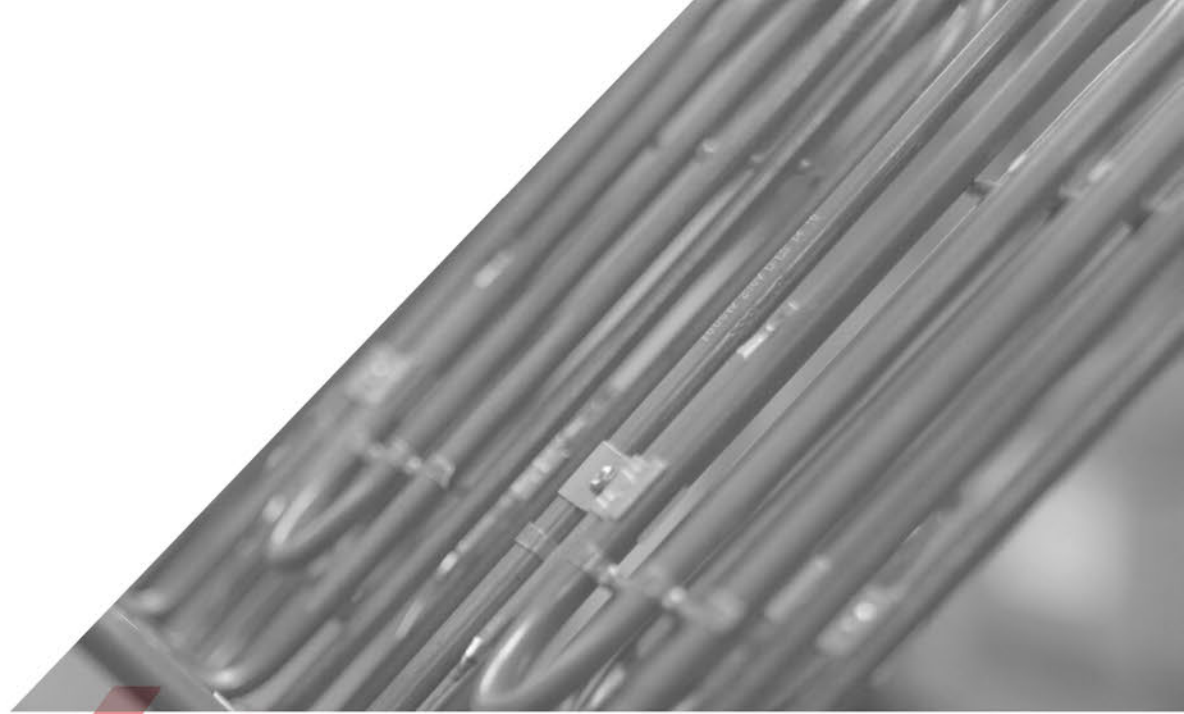

RECAMBIOS
SPARE PARTS
PIÈCES DÉTACHÉES



FREIDORAS

CODIGO	DESCRIPCION	PVP2019	CODIGO	DESCRIPCION	PVP2019
905030	BRIDA BULBO MOD.17 TRIFASICO	2,55	908251	JUNTA GRIFO MOD.5	1,42
905029	BRIDA BULBO MOD.35	2,50	908250	JUNTA GRIFO MOD.FH-10	1,65
905028	BRIDA BULBO MOD.4/10/17/25	1,26	908253	JUNTA NIVEL MOD.10/17/25/35	1,50
905036	BRIDA BULBO MOD.5/6/8/F-10	1,22	908252	JUNTA NIVEL MOD.5	1,42
905035	BRIDA GRIFO MOD.5	2,14	905225	JUNTA TORNILLO GRIFO MOD.5	0,15
907029	CABEZAL DC-6	207,16	905226	JUNTA TORNILLO NIVEL MOD.5/6	0,15
907030	CABEZAL DC-8/10	219,25	901510	MANDO INTERRUPTOR 40 AMPERIOS	9,50
907024	CABEZAL F10	138,11	907087	MANGO CESTA MOD.17/25	16,54
907021	CABEZAL FA4	121,75	907086	MANGO CESTA MOD.4/6/8/10	15,25
907022	CABEZAL FA6	125,32	907081	MANGO CESTA MOD.5	8,09
907025	CABEZAL FA-8/9/10 (V.2016)	129,45	901521	MANGO GRIFO MOD.5	11,00
907008	CABEZAL FAR10	691,67	901504	MANOPLA TERMOSTATO FREIDORA	3,00
907026	CABEZAL FAR17	698,84	905329	MUELLE BULBO TERMOSTATO FREIDORA	0,25
907004	CABEZAL FAR25	843,96	907032	NIVEL COMPLETO MOD.10/17	37,55
907876	CABEZAL MOD.10 230V	457,13	907103	NIVEL COMPLETO MOD.25/35	74,78
907877	CABEZAL MOD.10 400V	484,29	907006	NIVEL COMPLETO MOD.5/6	26,04
907878	CABEZAL MOD.17 230V	465,64	901622	PASACABLE CABEZALES FH	7,13
907879	CABEZAL MOD.17 400V	539,46	901620	PASACABLE MOD.5/6/8/10	1,50
907881	CABEZAL MOD.25	701,37	905359	PASADOR INOX 2,5X8 MANGO GRIFO	0,94
907882	CABEZAL MOD.35	714,25	905842	PATA FREIDORA	9,60
907002	CABEZAL MOD.5	99,53	901572	PILOTO RECTANGULAR MOD.5/6/10	2,03
907874	CABEZAL MOD.FA-10 230V MAX	480,50	901580	PILOTO REDONDO AMBAR 400V.	2,60
907872	CABEZAL MOD.FA-10 230V MAX DERECHO.	480,50	901582	PILOTO REDONDO INCOLORO 400V.	2,60
907875	CABEZAL MOD.FA-10 400V MAX	517,11	901581	PILOTO REDONDO ROJO 400V.	2,60
907873	CABEZAL MOD.FA-10 400V MAX DERECHO	517,11	901583	PILOTO REDONDO ROJO MOD.5	1,97
901055	CABLE CLAVIJA	4,25	907080	PLASTICO MANGO CESTA FREIDORA	4,80
908054	CADENA MOD.25	21,13	907085	PLASTICO MANGO CESTA FREIDORA LUX	7,62
908056	CADENA MOD.35	23,55	907007	POMO ELEVACION COMPLETO MOD.5/6	14,42
901060	CAPUCHON FASTON	0,10	908367	POMO ELEVACION PLASTICO 25/35	5,45
907044	CESTA FA-8/9/10	62,08	907105	POMO MANDO ELEVACION COMPLETO MOD.25/35	50,25
907038	CESTA MOD.10	63,85	907116	POMO MANDO ELEVACION MOD.10/17 COMPLETO	57,87
907041	CESTA MOD.17	82,94	908020	POMO TAPA FREIDORA	3,23
907042	CESTA MOD.25	94,49	908370	PRENSA ESTOPA CABEZAL FREIDORA	0,98
907033	CESTA MOD.25/2	73,25	905408	RACORD 3/4" GRIFO FA-8/10	10,16
907043	CESTA MOD.35	161,30	901688	RESISTENCIA MOD. FAR 10 10000W	206,27
907034	CESTA MOD.35/2	132,37	901686	RESISTENCIA MOD. FAR 17 17000W	209,39
907048	CESTA MOD.4	55,90	901687	RESISTENCIA MOD. FAR 25 25000W	282,28
907035	CESTA MOD.5	46,71	901675	RESISTENCIA MOD.10 6000W 230V	54,32
907047	CESTA MOD.6	60,15	901684	RESISTENCIA MOD.10 6000W 400V	88,62
901099	CESTA RESIDUOS MOD.5	25,29	901677	RESISTENCIA MOD.17 6000W 230V	65,77
905071	COJINETE EJE ELEVACION MOD.10/17	5,03	901678	RESISTENCIA MOD.17 7000W 400V	91,62
905058	COJINETE EJE ELEVACION MOD.5	2,65	901680	RESISTENCIA MOD.25 15000W	198,66
907155	CONJUNTO ELEVACION MOD.10/17	45,79	901681	RESISTENCIA MOD.35 15000W	207,98
907104	CONJUNTO ELEVACION MOD.25/35	92,41	901685	RESISTENCIA MOD.4 2000W	50,13
901154	CONTACTOR AF09-30-01-13 3P 230V.4KW	44,67	901701	RESISTENCIA MOD.5 2000W	16,06
901155	CONTACTOR AF09-30-01-14 3P 400V.4KW	44,67	901689	RESISTENCIA MOD.6 2900W NUEVO	35,25
901156	CONTACTOR AF09-30-10-13 3P 230V.4KW	44,67	901682	RESISTENCIA MOD.8/FA10 4000W	55,43
901157	CONTACTOR AF09-30-10-14 3P 400V.4KW	44,67	901690	RESISTENCIA MOD.F-10 4000W	42,85
901161	CONTACTOR AF26-30-00-14 3P 400V 11KW+AUXILIAR	112,51	901705	RESISTENCIA MOD.FA-10 6000W 230V MAX	156,63
905064	CREMALLERA MOD.F10	25,21	901706	RESISTENCIA MOD.FA-10 6000W 400V MAX	189,62
905055	CREMALLERA MOD.FH10/17	11,00	907018	RODILLO RESISTENCIA COMPLETO MOD.25/35	11,28
905134	EJE ELEVACION MOD.10/17	5,95	905429	SOPORTE CABEZAL MOD.4/6/9	6,33
908104	EMBRAGUE NYLON MOD.10/17	2,30	905420	SOPORTE FIJACION CABEZAL FREIDORA	15,47
908103	EMBRAGUE NYLON MOD.5	2,30	905451	TAPA CAJA CABEZAL MOD.5	5,27
908101	ESCUDO GOMA POMO ELEVACION MOD.25/35	4,97	905116	TAPA MOD.5	7,13
901281	ESCUDO TERMOSTATO	3,88	907011	TAPA MOD.17	20,74
907088	GRIFO COMPLETO F-5	40,88	907012	TAPA MOD.25	34,04
901372	GRIFO FREIDORA 1 1/4"	33,45	907013	TAPA MOD.35	59,45
901373	GRIFO FREIDORA 3/4" PALANCA	14,21	907010	TAPA MOD.F/FAP-10	17,16
901371	GRIFO FREIDORA 3/4" PALOMILLA	15,22	907009	TAPA MOD.FA-6/8/10	17,16
901374	GRIFO MOD.FH-10	22,50	907110	TERMOSTATO FREIDORA E20	22,69
901405	INTERRUPTOR GENERAL 32 AMPERIOS	74,12	901771	TERMOSTATO SEGURIDAD 5	12,42
901404	INTERRUPTOR GENERAL 40 AMPERIOS	82,89	901770	TERMOSTATO SEGURIDAD FREIDORA	14,65
908257	JUNTA CRISTAL NIVEL 10/17/25/35	1,42	908701	TORNILLO 12X2.5X15 M-5 INOX	0,27
908255	JUNTA GRIFO 3/4" FREIDORA	1,00	905361	ZOCALO MOD.5	8,13

VITRINAS

CODIGO	DESCRIPCION	PVP2019	CODIGO	DESCRIPCION	PVP2019
916810	BANDEJA GASTRONORM 1/3	17,04	919047	CRISTAL IRON/TOP 8 ROJO 1 PISO	310,00
916815	COMPRESOR VITRINA TL5	143,49	919049	CRISTAL IRON/TOP 8 ROJO 2 PISOS	322,05
11227640	CRISTAL CALENTADOR 4 BANDEJAS	187,85	916967	ESTANTE CUB 8B 2P	150,00
11227610	CRISTAL CALENTADOR 6 BANDEJAS	191,99	914002	ESTANTE ONIX 6 2P 1468X313	93,75
1224180	CRISTAL EXPOSITOR 1 PISO	97,79	914004	ESTANTE ONIX 6 2P REMOTO 1127X313	84,41
1224190	CRISTAL EXPOSITOR 2 PISOS	87,19	914003	ESTANTE ONIX 8 2P 1807X313	113,15
918590	CRISTAL EXPOSITOR ONIX 4 2 PISOS NEGRO	239,93	914005	ESTANTE ONIX 8 2P REMOTO 1468X313	92,13
918575	CRISTAL EXPOSITOR ONIX 4 BLANCO	180,64	916898	ESTANTE V6 2 PISOS	56,98
918574	CRISTAL EXPOSITOR ONIX 4 NEGRO	180,64	916899	ESTANTE V8 2 PISOS	56,21
918585	CRISTAL EXPOSITOR ONIX 4 REMOTO	177,16	918554	FUENTE DE ALIMENTACION LED 30W.	19,72
918576	CRISTAL EXPOSITOR ONIX 4 ROJO	180,64	918996	GRUPO FRIO INCORPORADO CON LED	347,50
918588	CRISTAL EXPOSITOR ONIX 6 2PISOS BLANCO	188,90	918999	GRUPO FRIO REMOTO CON LED	434,78
918587	CRISTAL EXPOSITOR ONIX 6 2PISOS NEGRO	188,90	916840	INTERRUPTOR RECT. COJ 30X11 20A	4,97
918596	CRISTAL EXPOSITOR ONIX 6 2PISOS REMOTO	188,90	916784	JUEGO PUERTAS CUB/P.F. 4	30,36
918589	CRISTAL EXPOSITOR ONIX 6 2PISOS ROJO	188,90	916785	JUEGO PUERTAS CUB/P.F. 6	30,67
918578	CRISTAL EXPOSITOR ONIX 6 BLANCO	185,31	916786	JUEGO PUERTAS CUB/P.F. 8	36,35
918577	CRISTAL EXPOSITOR ONIX 6 NEGRO	185,31	916789	JUEGO PUERTAS JADE 4	30,55
918583	CRISTAL EXPOSITOR ONIX 6 REMOTO	185,31	916790	JUEGO PUERTAS JADE 6	31,69
918579	CRISTAL EXPOSITOR ONIX 6 ROJO	185,31	916791	JUEGO PUERTAS JADE 8	32,23
918594	CRISTAL EXPOSITOR ONIX 8 2PISOS BLANCO	194,81	916842	JUEGO PUERTAS ONIX/IRON/TOP-4	22,74
918593	CRISTAL EXPOSITOR ONIX 8 2PISOS NEGRO	194,81	916851	JUEGO PUERTAS ONIX/IRON/TOP-6	27,81
918597	CRISTAL EXPOSITOR ONIX 8 2PISOS REMOTO	194,81	916879	JUEGO PUERTAS ONIX/IRON/TOP-8	29,79
918595	CRISTAL EXPOSITOR ONIX 8 2PISOS ROJO	194,81	918559	LATERAL DER. RANURADO 2P ONIX	70,93
918581	CRISTAL EXPOSITOR ONIX 8 BLANCO	192,80	918604	LATERAL DER. RANURADO JADE	35,51
918580	CRISTAL EXPOSITOR ONIX 8 NEGRO	192,80	918556	LATERAL DER. RANURADO ONIX	60,06
918584	CRISTAL EXPOSITOR ONIX 8 REMOTO	192,80	918564	LATERAL DER. RANURADO PF ONIX	59,33
918582	CRISTAL EXPOSITOR ONIX 8 ROJO	192,80	918567	LATERAL DER. TRANSPARENTE ONIX R	45,88
916819	CRISTAL EXPOSITOR VECI/JADE/TWIN 4	180,64	918568	LATERAL DER. TRANSPARENTE ONIX R 2P	58,86
916820	CRISTAL EXPOSITOR VECI/JADE/TWIN 6	185,31	918569	LATERAL DER. TRANSPARENTE PF ONIX	40,06
916896	CRISTAL EXPOSITOR VECI/JADE/TWIN 6 2PISOS	216,89	918370	LATERAL DERECHO RANURADO CUB	49,83
916821	CRISTAL EXPOSITOR VECI/JADE/TWIN 8	192,80	1224170	LATERAL EXPOSITOR 1 PISO CURVO	23,84
916897	CRISTAL EXPOSITOR VECI/JADE/TWIN 8 2PISOS	238,80	1224120	LATERAL EXPOSITOR 1 PISO PLANO	22,49
916937	CRISTAL FRONTAL CUB 6B2 P	120,75	1224160	LATERAL EXPOSITOR 2 PISOS CURVADO	34,91
916965	CRISTAL FRONTAL CUB 8B 2P	127,37	1224150	LATERAL EXPOSITOR 2 PISOS PLANO	33,24
916948	CRISTAL FRONTAL CUB V4 HOT	36,55	918603	LATERAL IQZ. TRANS. JADE	42,64
916954	CRISTAL FRONTAL CUB V4 NEUTRA	36,03	918560	LATERAL IQZ. TRANSPARENTE 2P ONIX	59,35
916950	CRISTAL FRONTAL CUB V6 HOT	39,63	918557	LATERAL IQZ. TRANSPARENTE ONIX	40,56
916956	CRISTAL FRONTAL CUB V6 NEUTRA	38,71	918565	LATERAL IQZ. TRANSPARENTE PF ONIX	40,06
916952	CRISTAL FRONTAL CUB V8 HOT	48,55	918634	LATERAL IQZ. TRANSPARENTE PR SUSHI ONIX	41,23
916958	CRISTAL FRONTAL CUB V8 NEUTRA	47,23	918562	LATERAL IQZ. TRANSPARENTE SUSHI ONIX	55,26
916930	CRISTAL FRONTAL CUB-4	74,69	918371	LATERAL IZQUIERDO TRANSPARENTE CUB	58,60
916932	CRISTAL FRONTAL CUB-6	84,70	918377	LATERAL RANURADO CUB 2P	61,10
916934	CRISTAL FRONTAL CUB-8	94,73	801001	LATERAL RANURADO IRON 1P	58,18
916826	CRISTAL MOTOR BLANCO	82,07	801004	LATERAL RANURADO IRON 2P	93,99
916827	CRISTAL MOTOR NEGRO	82,07	918391	LATERAL RANURADO TOP / TOP SUSHI 1P	58,07
916966	CRISTAL SUPERIOR CUB 8B 2P	146,44	918394	LATERAL RANURADO TOP 2P	68,90
916949	CRISTAL SUPERIOR CUB V4 HOT	46,67	918365	LATERAL TRANS. CUB LADO CONTRARIO	62,34
916955	CRISTAL SUPERIOR CUB V4 NEUTRA	44,17	801000	LATERAL TRANS. IRON 1P	61,42
916951	CRISTAL SUPERIOR CUB V6 HOT	60,79	801003	LATERAL TRANS. IRON 2P	78,74
916957	CRISTAL SUPERIOR CUB V6 NEUTRA	59,33	918390	LATERAL TRANS. TOP 1P	58,12
916953	CRISTAL SUPERIOR CUB V8 HOT	75,93	918393	LATERAL TRANS. TOP 2P	68,90
916959	CRISTAL SUPERIOR CUB V8 NEUTRA	73,48	918396	LATERAL TRANS. TOP SUSHI	58,36
916931	CRISTAL SUPERIOR CUB-4	109,42	918378	LATERAL TRANSPARENTE CUB 2P	67,21
916933	CRISTAL SUPERIOR CUB-6	127,95	918489	MOTOR VENTILADOR 10W SOP.H-39	29,10
916935	CRISTAL SUPERIOR CUB-8	154,07	14310410	PUERTAS CALENTADOR 6 BANDEJAS	13,25
919040	CRISTAL IRON/TOP 4 BLANCO 1 PISO	234,41	14310300	PUERTAS EXPOSITOR 1 PISO	16,33
919042	CRISTAL IRON/TOP 4 BLANCO 2 PISOS	245,35	14310280	PUERTAS EXPOSITOR 2 PISOS	22,31
916913	CRISTAL IRON/TOP 4 NEGRO 1 PISO	234,41	14331150	SOPORTE ESTANTE DERECHO	1,62
916914	CRISTAL IRON/TOP 4 NEGRO 2 PISOS	245,35	14331160	SOPORTE ESTANTE IZQUIERDO	1,62
919039	CRISTAL IRON/TOP 4 ROJO 1 PISO	234,41	914001	SOPORTE ESTANTE VITRINA 2P	1,46
919041	CRISTAL IRON/TOP 4 ROJO 2 PISOS	245,35	916872	SOPORTE VITRINA	47,73
919044	CRISTAL IRON/TOP 6 BLANCO 1 PISO	251,02	918571	TAPA COMPRESOR ONIX	44,91
919046	CRISTAL IRON/TOP 6 BLANCO 2 PISOS	263,00	918373	TAPA MOTOR CUB	57,04
916915	CRISTAL IRON/TOP 6 NEGRO 1 PISO	251,02	916986	TERMOSTATO VITRINA CAREL	41,00
916916	CRISTAL IRON/TOP 6 NEGRO 2 PISOS	263,00	918552	TIRA LED 1040 MM	40,41
919043	CRISTAL IRON/TOP 6 ROJO 1 PISO	251,02	918553	TIRA LED 1400 MM	50,11
919045	CRISTAL IRON/TOP 6 ROJO 2 PISOS	263,00	918551	TIRA LED 700 MM	31,52
919048	CRISTAL IRON/TOP 8 BLANCO 1 PISO	310,00	918544	TIRA LED REMOTA/HOT 1090MM	42,02
919050	CRISTAL IRON/TOP 8 BLANCO 2 PISOS	322,05	918545	TIRA LED REMOTA/HOT 1450MM	51,73
916917	CRISTAL IRON/TOP 8 NEGRO 1 PISO	310,00	918543	TIRA LED REMOTA/HOT 750MM	32,32
916918	CRISTAL IRON/TOP 8 NEGRO 2 PISOS	322,05	14340130	TOPE GOMA PIE	2,00



INDUSTRIA 90

CONDICIONES DE VENTA

PEDIDOS

Los pedidos deberán dirigirse a nuestras instalaciones centrales de INDUSTRIA 90 S.L., deberán ser siempre por escrito vía email o web. Una vez efectuada la expedición los pedidos no podrán anularse. Queda reservado el derecho de no admitir pedidos a aquellos clientes que hayan incumplido anteriores contratos.

PORTES

Los portes serán pagados a partir de un pedido mínimo de 400 euros. Siempre que los portes sean pagados INDUSTRIA 90 se hará cargo de los daños derivados del transporte siempre y cuando se haga constar en el albarán de transporte los desperfectos ocasionados. El comprador tiene 24 horas para notificar cualquier anomalía, pasado este tiempo INDUSTRIA 90 no podrá atender ninguna reclamación.

CONDICIONES DE PAGO

El pago de las facturas se realizará al contado salvo que se otorgue crédito al cliente en cuyo caso se efectuará el pago en la forma y lugar acordado. Si antes o durante la cumplimentación de un pedido se produjese el incumplimiento en los pagos, se podrá demorar la entrega de la mercancía mientras el comprador no anticipe el pago de los mismos.

EMBALAJE

El embalaje estándar está incluido en los precios, los embalajes marítimos y especiales se cargarán en factura.

PRECIOS

Los precios que figuran en la presente tarifa son precios venta público en euros y en nuestras instalaciones centrales. INDUSTRIA 90 se reserva el derecho de modificar los precios sin previo aviso.

GARANTIA

La garantía será la establecida según la ley vigente, cubriendo solamente los defectos de fabricación quedando excluido la mala o indebida utilización del producto por el usuario. Las indemnizaciones, desplazamientos y mano de obra no están cubiertas por esta garantía. INDUSTRIA 90 se reserva el derecho de solicitar el envío de la pieza o piezas a sustituir sin cargo y a portes pagados para su comprobación.

DEVOLUCIONES

No se admitirán devoluciones sin previa autorización de INDUSTRIA 90. Todos los gastos ocasionados por la devolución de la mercancía serán a cargo del cliente. La mercancía debe ser devuelta con su embalaje original. No se aceptará mercancía sin su embalaje original o que haya sufrido cualquier uso o manipulación. De su importe se deducirá un 10% en concepto de gastos de recepción, prueba o inspección, independientemente de que en cada caso se pueda hacer otra valoración.

PROPIEDAD DE LA MERCANCIA

Toda mercancía que no esté totalmente pagada es propiedad de INDUSTRIA 90 aunque permanezca en stock del comprador.

JURISDICCION

En caso de litigio sólo serán competentes los tribunales de Barcelona.

INDUSTRIA 90 S.L., se reserva el derecho de efectuar variantes de diseño y acabados sin previo aviso así como características técnicas.

Esta tarifa anula y sustituye a todas las anteriores.



INDUSTRIA 90



INDUSTRIA 90



1962
Since