



YOUR OUTDOOR LIVING

garden
collection
2016

feeling better



garden collection 2016

design by
Raffaello Galiotto

#feelingbetter è profumo d'estate, di cene all'aria aperta, di giochi in giardino, di notti stellate.

#feelingbetter è baciarsi al chiaro di luna, assaporare un gelato, leggere il libro preferito, scambiarsi confidenze fra amici.

Da 25 anni Nardi lavora per far sentire bene le persone proponendo arredi per l'outdoor dal carattere giovane, frizzante, coloratissimo ... uno stile easy-chic che interpreta la voglia di vivere all'aria aperta. Tavoli, sedute, poltroncine relax, lettini prendisole dai colori pieni, brillanti e resistenti agli agenti atmosferici, atossici, completamente riciclabili e, in alcuni casi, anche allungabili o ripiegabili. Tutto rigorosamente Made in Italy.

Per respirare gioia e relax, per sentirsi bene e far star bene gli altri.

Nardi, #feelingbetter

#feelingbetter is the scent of summer, outdoor meals, games in the garden, starlit nights.

#feelingbetter is kissing in the moonlight, enjoying an ice-cream, reading your favourite book, sharing stories with friends.

For 25 years Nardi has strived to make people feel better by creating fresh, colourful and jazzy outdoor furniture... Nardi brings an easy-chic style which interprets its clients desire to enjoy life in the open air. Tables, chairs, relaxing armchairs and sunbeds with colourful designs, bright features, created for all types of weather, non-toxic, entirely recyclable and, in some cases, even foldable or extendable. All Nardi's furniture is rigorously Made in Italy. Breathe in happiness and relaxation. Feel better and make others feel better too.

Nardi, #feelingbetter





alloro net

alloro 210 extensible
210 / 280 cm
8 / 10 🧑





alloro
210 extensibile

net









alloro palma

alloro 140 extensibile
140 / 210 cm
6 / 8 





alloro
140 extensibile

palma





alloro aria

alloro 210 extensible
210 / 280 cm
8 / 10 🧑





aria

alloro
210 estensibile

loto ninfea dinner

loto dinner 190
190 x 100 cm
6 





loto
dinner 190

ninfea
dinner





libeccio acquamarina

libeccio
160 / 220 cm
6 / 8 









acquamarina

libeccio





levante bora

levante
160 / 220 cm
6 / 8 





bora

levante





maestrale musa

maestrale
160 / 220 cm
6 / 8 





maestrale

musa





aria

aria tavolino 60
60 cm





aria tavolino 60

aria poltrona









spritz zac

spritz
ø 60,5 cm





zac spring





spritz

zac spring

step acquamarina

step
ø 60,5 cm





step

acquamarina





loto ninfea relax

loto relax 95





loto relax 95

ninfea relax





atlantico



atlantico









net new

polipropilene fiberglass

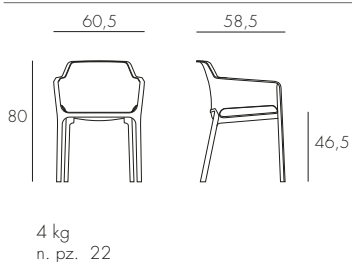

BIANCO 40326.00.000 ANTRACITE 40326.02.000 TORTORA 40326.10.000 SENAPE 40326.56.000 CORALLO 40326.75.000

palma

polipropilene

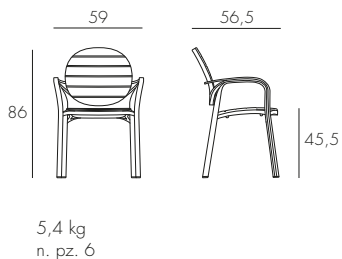

BIANCO 40237.00.000 BIANCO TORTORA 40237.00.010 BIANCO AVANA 40237.00.033 ANTRACITE 40237.02.002 CAFFÈ 40237.05.005 TORTORA 40237.10.010

erica

polipropilene

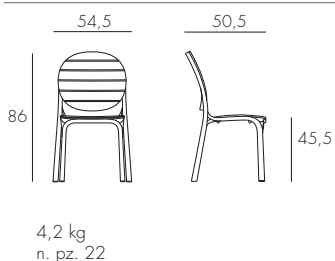

BIANCO 40236.00.000 BIANCO TORTORA 40236.00.010 BIANCO AVANA 40236.00.033 ANTRACITE 40236.02.002 CAFFÈ 40236.05.005 TORTORA 40236.10.010

ninfea dinner

polipropilene
alluminio

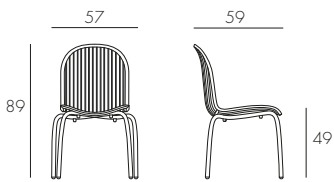

4,6 kg
n. pz. 6



BIANCO
anodizzato
62050.00.000



ANTRACITE
anodizzato
62050.02.000



CAFFÈ
anodizzato
62050.05.000



BIANCO
vernic. bianco
62053.00.000

ninfea relax

polipropilene
alluminio

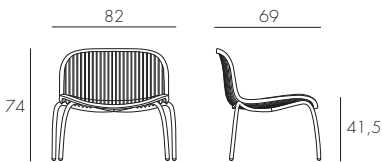

7,2 kg
n. pz. 2



BIANCO
anodizzato
62250.00.000



ANTRACITE
anodizzato
62250.02.000



CAFFÈ
anodizzato
62250.05.000



BIANCO
vernic. bianco
62253.00.000

acquamarina

polipropilene fiberglass

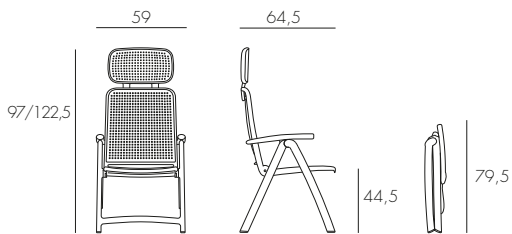

8,2 kg
n. pz. 1



BIANCO
40314.00.000



ANTRACITE
40314.02.000



CAFFÈ
40314.05.000



TORTORA
40314.10.000



CELESTE
40314.39.000

darsena **new**

polipropilene fiberglass

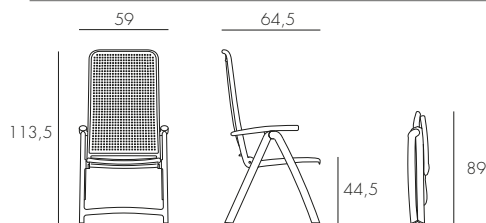

n. pz. 1



BIANCO
40316.00.000



ANTRACITE
40316.02.000



CAFFÈ
40316.05.000



TORTORA
40316.10.000



CELESTE
40316.39.000

bora

polipropilene fiberglass

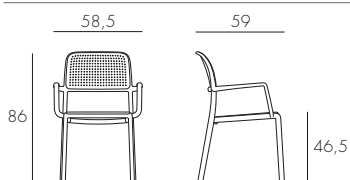

4,4 kg
n. pz. 24



BIANCO
40242.00.000



ANTRACITE
40242.02.000



CAFFÈ
40242.05.000



ROSSO
40242.07.000



TORTORA
40242.10.000



AVANA
40242.33.000



CELESTE
40242.39.000

bora bistrot

polipropilene fiberglass

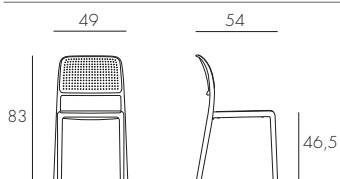

3,7 kg
n. pz. 24



BIANCO
40243.00.000



ANTRACITE
40243.02.000



CAFFÈ
40243.05.000



ROSSO
40243.07.000



TORTORA
40243.10.000



LIME
40243.12.000



PURPLE
40243.13.000



ARANCIO
40243.26.000



AVANA
40243.33.000



CELESTE
40243.39.000

riva

polipropilene fiberglass

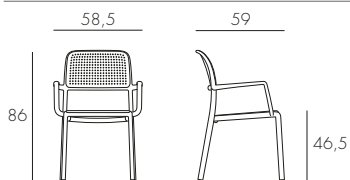

4,6 kg
n. pz. 24



BIANCO
40246.00.000



ANTRACITE
40246.02.000



CAFFÈ
40246.05.000



ROSSO
40246.07.000



TORTORA
40246.10.000



CELESTE
40246.39.000

riva bistrot

polipropilene fiberglass

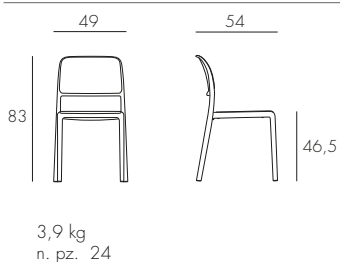

BIANCO
40247.00.000



ANTRACITE
40247.02.000



CAFFÈ
40247.05.000



ROSSO
40247.07.000



TORTORA
40247.10.000



LIME
40247.12.000



ARANCIO
40247.26.000



AVANA
40247.33.000



CELESTE
40247.39.000

costa

polipropilene fiberglass

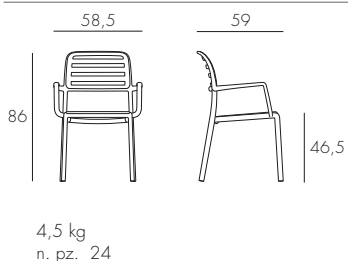

BIANCO
40244.00.000



ANTRACITE
40244.02.000



CAFFÈ
40244.05.000



ROSSO
40244.07.000



TORTORA
40244.10.000



CELESTE
40244.39.000

costa bistrot

polipropilene fiberglass

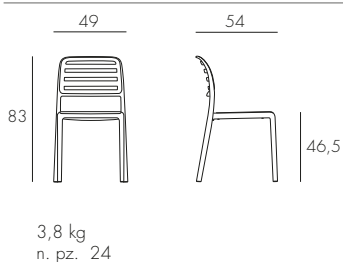

BIANCO
40245.00.000



ANTRACITE
40245.02.000



CAFFÈ
40245.05.000



ROSSO
40245.07.000



TORTORA
40245.10.000



LIME
40245.12.000



ARANCIO
40245.26.000



CELESTE
40245.39.000

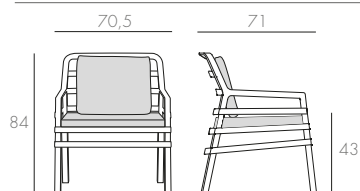

7,9 kg
n. pz. 1

BIANCO lime 40330.00.061.061	BIANCO cherry 40330.00.065.065	BIANCO melanzana 40330.00.068.068	BIANCO bianco 40330.00.155.155	BIANCO grigio 40330.00.163.163	BIANCO caffè 40330.00.165.165	BIANCO arancio 40330.00.166.166
ANTRACITE lime 40330.02.061.061	ANTRACITE cherry 40330.02.065.065	ANTRACITE melanzana 40330.02.068.068	ANTRACITE bianco 40330.02.155.155	ANTRACITE grigio 40330.02.163.163	ANTRACITE caffè 40330.02.165.165	ANTRACITE arancio 40330.02.166.166
CAFFÈ lime 40330.05.061.061	CAFFÈ cherry 40330.05.065.065	CAFFÈ melanzana 40330.05.068.068	CAFFÈ bianco 40330.05.155.155	CAFFÈ grigio 40330.05.163.163	CAFFÈ caffè 40330.05.165.165	CAFFÈ arancio 40330.05.166.166
ROSSO lime 40330.07.061.061	ROSSO cherry 40330.07.065.065	ROSSO melanzana 40330.07.068.068	ROSSO bianco 40330.07.155.155	ROSSO grigio 40330.07.163.163	ROSSO caffè 40330.07.165.165	ROSSO arancio 40330.07.166.166
TORTORA lime 40330.10.061.061	TORTORA cherry 40330.10.065.065	TORTORA melanzana 40330.10.068.068	TORTORA bianco 40330.10.155.155	TORTORA grigio 40330.10.163.163	TORTORA caffè 40330.10.165.165	TORTORA arancio 40330.10.166.166
AVANA lime 40330.33.061.061	AVANA cherry 40330.33.065.065	AVANA melanzana 40330.33.068.068	AVANA bianco 40330.33.155.155	AVANA grigio 40330.33.163.163	AVANA caffè 40330.33.165.165	AVANA arancio 40330.33.166.166

* Disponibile a magazzino - Available ex-stock - Disponible sur stock - Ab Lager verfügbar - Disponible en almacén habitualmente - Disponível em estoque - Наличие на складе

* Disponibile su ordine - Available to order - Disponible sur commande - Mit Auftrag verfügbar - Disponible sólo sobre pedido - Disponível sob encomenda - Под заказ

- melanzana - bianco - caffè - arancio = acrilico 190 gr/m²
lime - cherry - grigio = acrilico 240 gr/m²

musa

polipropilene
alluminio

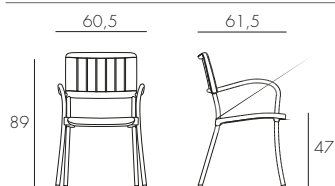

4,2 kg
n. pz. 24



BIANCO
anodizzato argento
61050.00.000

CAFFÈ
anodizzato argento
61050.05.000

TORTORA
anodizzato argento
61050.10.000

ANTRACITE
verniciato antracite
61052.02.000

TORTORA
verniciato tortora
61059.10.000

zac classic

polipropilene fiberglass



3,9 kg
n. pz. 1



BIANCO
40324.00.000

GRIGIO
40324.03.000

LIME
40324.12.000

PURPLE
40324.13.000

ARANCIO
40324.26.000

zac spring

polipropilene fiberglass



3,9 kg
n. pz. 1



BIANCO
40325.00.000

ANTRACITE
40325.02.000

ROSSO
40325.07.000

LIME
40325.12.000

PURPLE
40325.13.000

ARANCIO
40325.26.000

alloro 140 extensibile 6/8

durelTOP - polipropilene
alluminio

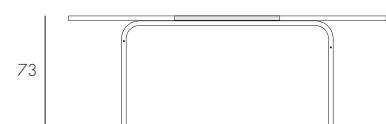
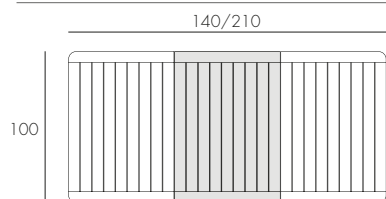

33,7 kg
n. pz. 1



BIANCO
verniciato bianco
42753.00.000



TORTORA
verniciato bianco
42753.10.000



AVANA
verniciato bianco
42753.33.000



ANTRACITE
verniciato antracite
42752.02.000



CAFFÈ
verniciato caffè
42757.05.000



TORTORA
verniciato tortora
42759.10.000

alloro 210 extensibile 8/10

new

durelTOP - polipropilene
alluminio

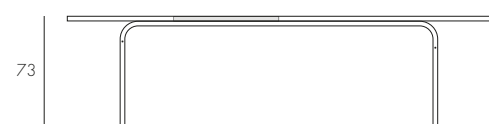
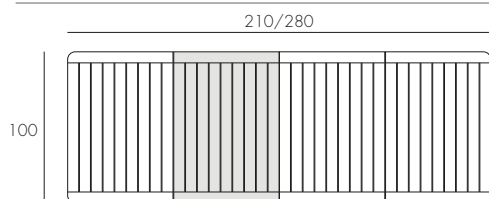

44,4 kg
n. pz. 1



BIANCO
verniciato bianco
42853.00.000



TORTORA
verniciato bianco
42853.10.000



AVANA
verniciato bianco
42853.33.000



ANTRACITE
verniciato antracite
42852.02.000



CAFFÈ
verniciato caffè
42857.05.000



TORTORA
verniciato tortora
42859.10.000

libeccio 6/8

durelTOP - polipropilene
alluminio

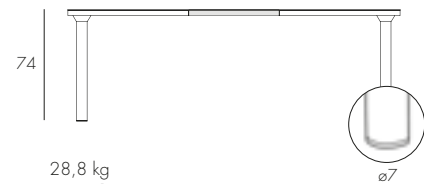
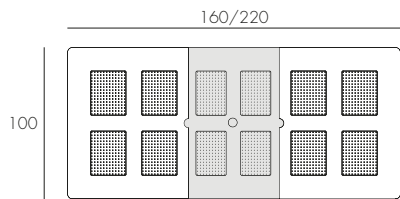

28,8 kg
n. pz. 1



BIANCO
verniciato bianco
47553.00.000

ANTRACITE
verniciato antracite
47552.02.000

CAFFÈ
verniciato caffè
47557.05.000

TORTORA
verniciato tortora
47559.10.000

levante 6/8

durelTOP - polipropilene
alluminio

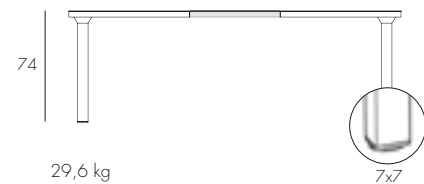
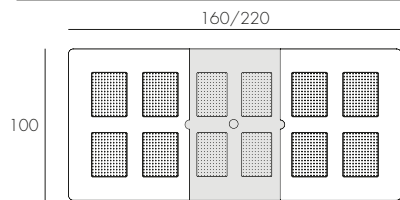

29,6 kg
n. pz. 1



BIANCO
verniciato bianco
47053.00.000

ANTRACITE
verniciato antracite
47052.02.000

CAFFÈ
verniciato caffè
47057.05.000

TORTORA
verniciato tortora
47059.10.000

maestrale 6/8

durelTOP - polipropilene
alluminio

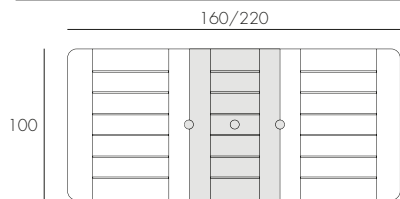

31,3 kg
n. pz. 1



BIANCO
anodizzato
42250.00.000

CAFFÈ
anodizzato
42250.05.000

TORTORA
anodizzato
42250.10.000

ANTRACITE
verniciato antracite
42252.02.000

TORTORA
verniciato tortora
42259.10.000

loto dinner ø120

vetro
alluminio

ø 120

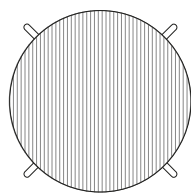

BIANCO
anodizzato
44350.00.000



ANTRACITE
anodizzato
44350.02.000



CAFFÈ
anodizzato
44350.05.000



BIANCO
verniciato bianco
44353.00.000

73

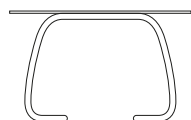

34 kg
n. pz. 1

loto dinner ø170

vetro
alluminio

ø 172

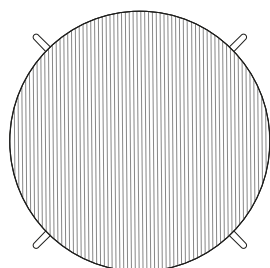

BIANCO
anodizzato
44450.00.000



ANTRACITE
anodizzato
44450.02.000



CAFFÈ
anodizzato
44450.05.000



BIANCO
verniciato bianco
44453.00.000

73

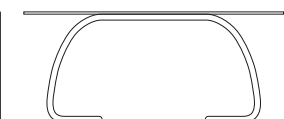

65,3 kg
n. pz. 1

loto dinner 190

vetro
alluminio

190

100



BIANCO
anodizzato
44050.00.000



ANTRACITE
anodizzato
44050.02.000



CAFFÈ
anodizzato
44050.05.000



BIANCO
verniciato bianco
44053.00.000

73

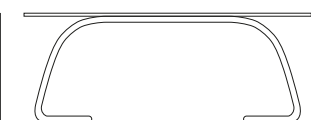

49,8 kg
n. pz. 1

loto relax 95

vetro
alluminio

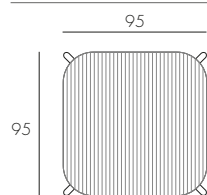

27 kg
n. pz. 1



BIANCO
anodizzato
44750.00.000



ANTRACITE
anodizzato
44750.02.000



CAFFÈ
anodizzato
44750.05.000



BIANCO
verniciato bianco
44753.00.000

loto relax 60

laminato
alluminio

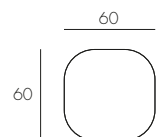

7 kg
n. pz. 1



BIANCO
anodizzato
44650.00.301



ANTRACITE
anodizzato
44650.00.303



CAFFÈ
anodizzato
44650.00.302



BIANCO
verniciato bianco
44653.00.301

aria tavolino 60

polipropilene

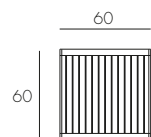

5 kg
n. pz. 1



BIANCO
40051.00.000



ANTRACITE
40051.02.000



CAFFÈ
40051.05.000



ROSSO
40051.07.000



TORTORA
40051.10.000



AVANA
40051.33.000

aria tavolino 100

polipropilene

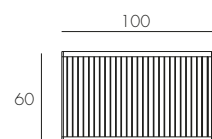

6,9 kg
n. pz. 1



BIANCO
40052.00.000



ANTRACITE
40052.02.000



CAFFÈ
40052.05.000



ROSSO
40052.07.000



TORTORA
40052.10.000



AVANA
40052.33.000

step

polipropilene fiberglass

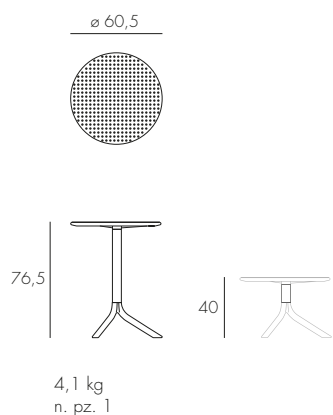

BIANCO
40056.00.000



ANTRACITE
40056.02.000



CAFFÈ
40056.05.000



ROSSO
40056.07.000



TORTORA
40056.10.000



LIME
40056.12.000



PURPLE
40056.13.000



ARANCIO
40056.26.000



AVANA
40056.33.000



CELESTE
40056.39.000

spritz

polipropilene fiberglass

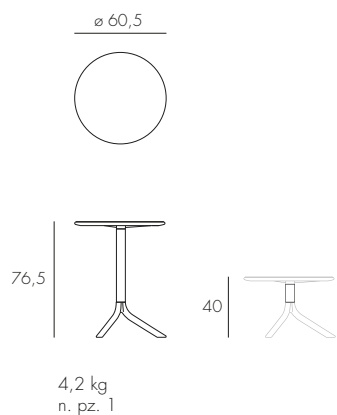

BIANCO
40058.00.000



ANTRACITE
40058.02.000



CAFFÈ
40058.05.000



ROSSO
40058.07.000



TORTORA
40058.10.000



LIME
40058.12.000



ARANCIO
40058.26.000



CELESTE
40058.39.000

zic

polipropilene fiberglass

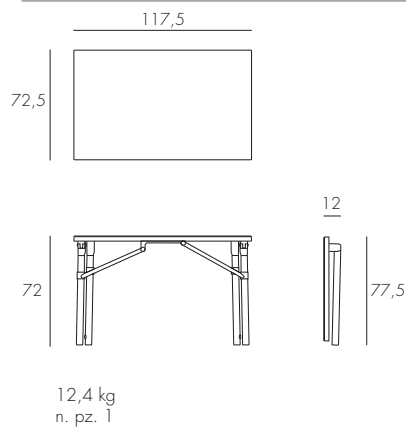

BIANCO
40125.00.000



LIME
40125.12.000



ARANCIO
40125.26.000

atlantico

polipropilene fiberglass
tessuto sintetico 1x1

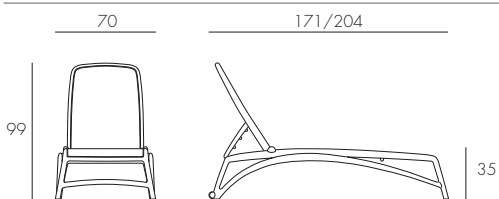

16 kg
n. pz. 20

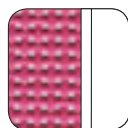

BIANCO
rosa
40450.00.056

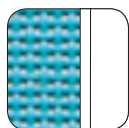

BIANCO
celeste
40450.00.075

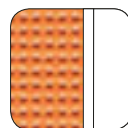

BIANCO
mandarino
40450.00.083

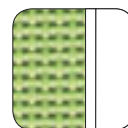

BIANCO
prato
40450.00.084

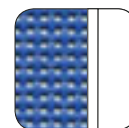

BIANCO
blu
40450.00.102

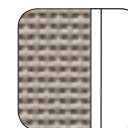

BIANCO
tortora
40450.00.104

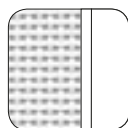

BIANCO
bianco
40450.00.107



ANTRACITE
antracite
40450.02.057

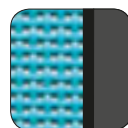

ANTRACITE
celeste
40450.02.075



CAFFÈ
tortora
40450.05.104



CAFFÈ
prato
40450.05.084



CAFFÈ
celeste
40450.05.075

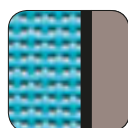

TORTORA
celeste
40450.10.075

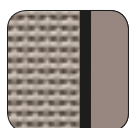

TORTORA
tortora
40450.10.104

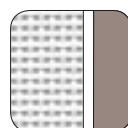

TORTORA
bianco
40450.10.107

bracciolo atlantico **new**

polipropilene fiberglass

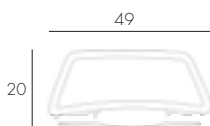

1,1 kg
n. pz. 1

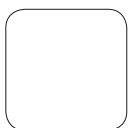

BIANCO
40452.00.000



ANTRACITE
40452.02.000



CAFFÈ
40452.05.000



TORTORA
40452.10.000

polipropilene

Polipropilene trattato anti-UV e colorato in massa. Riciclabile al 100%.
Polypropylene with UV additives and is uniformly colored. 100% Recyclable resin.
Polypropylène traité anti-UV et coloré dans la masse. Résine recyclable 100%.
UV-beständigem Polypropylen, voll durchgefärbt. 100% Recyclebarer Kunststoff.
Polipropileno tratado anti UV y teñido en masa. Resina reciclable 100%.
Polipropileno com tratamento anti-UV colorido na totalidade. Resina reciclável 100%.
Полипропилен с обработкой анти-УФ, окрашенное в массе. На 100% пригодно для вторичной переработки.

polipropilene fiberglass

Polipropilene fiberglass trattato anti-UV e colorato in massa. Resina riciclabile al 100%.
Uniformly colored fiberglass polypropylene resins with uv additives. 100% Recyclable resin.
Polypropylène fiberglass traité anti-uv et coloré dans la masse. Résine recyclable 100%.
UV-beständigem fiberglass Polypropylen, voll durchgefärbt. 100% Recyclebarer Kunststoff.
Polipropileno fiberglass tratado anti UV y teñido en masa. Resina reciclable 100%.
Polipropileno fiberglass com tratamento anti-UV colorido na totalidade. Resina reciclável 100%.
Полипропилен фиброволокно с обработкой анти-УФ, окрашенное в массе. На 100% пригодно для вторичной переработки.

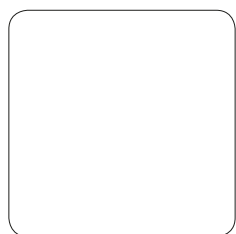

BIANCO .00



ANTRACITE .02



GRIGIO .03

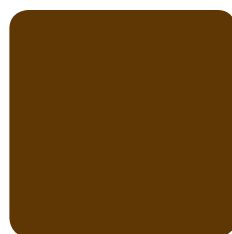

CAFFE' .05



ROSSO .07



TORTORA .10



LIME .12



PURPLE .13



ARANCIO .26



AVANA .33



CELESTE .39



SENAPE .56



CORALLO .75

durelTOP



DurelTOP è un sistema innovativo di produzione di piani per tavoli studiati per raggiungere i più elevati livelli di praticità, resistenza, robustezza ed eleganza. I piani DurelTOP sono ad alto spessore, formati da un doppio strato tamburato perfettamente chiuso. Prodotti in polipropilene di prima qualità, sono inalterabili all'acqua, resistenti al sole e facili da pulire. DurelTOP è il risultato di una lunga ricerca tecnologica e dell'esperienza decennale nella lavorazione delle materie plastiche della NARDI, da sempre all'avanguardia nell'ambiente contract e giardino.

The DurelTOP is an innovative new system in the production of tabletops developed to reach the highest levels of practicality, resistance, and elegance. The DurelTOP tabletops have a greater thickness, formed by a double layer enclosure perfectly closed. Produced in first quality polypropylene, they are resistant to water, resistant to sunlight, and are easy to clean. DurelTOP is a result of a decade's long research and development in plastics by Nardi, always a leader in the contract and garden sectors.

DurelTOP est un système innovateur de production de plateaux de tables, il est étudié pour retrouver le meilleur niveau de pratique de résistance et d'élégance. Les plateaux DurelTOP sont très épais, formés de doubles couches parfaitement finies. Ce sont des produits

en polypropylène de première qualité, ils sont inaltérables à l'eau, résistant au soleil et faciles à nettoyer. DurelTOP est le résultat d'une longue recherche technologique et une expérience décennale dans le travail des matières plastique de la Sié NARDI, toujours à l'avant-garde dans le secteur du contract et jardin.

DurelTOP ist ein neu entwickeltes System für die Produktion von Tischplatten, um ein Höchstmaß an Funktionalität, Widerstandsfähigkeit und Eleganz zu erreichen. Durch das innen verstärktes "Zwei-Schichten-Hohlraum-System" erreicht die DurelTOP Tischplatte einen stärkeren Querschnitt und damit ein Höchstmaß an Festigkeit. Hergestellt aus hochwertigem Qualitätspolypropylen ist sie resistent gegen Wasser und Sonnenlicht und dabei leicht zu reinigen. DurelTOP ist das Ergebnis von 10 Jahren Forschung und Entwicklung auf dem Kunststoffsektor durch Nardi, immer der führende im Bereich Contract- und Gartenmöbel.

DurelTOP es un nuevo sistema de fabricación de tableros de mesa estudiado para alcanzar los mas altos niveles de practicidad, resistencia, robustez y elegancia. Los tableros DurelTOP de gran solidez, estan formados por una doble capa perfectamente unida y sellada. Fabricados en polipropileno de primera calidad son inalterables al agua, resistentes al sol y de fácil limpieza. DurelTOP es

el resultado de una prolongada investigación tecnológica y de la experiencia acumulada en los mas de diez años que Nardi lleva produciendo materias plasticas, siempre innovando en ambientes contract y jardín.

DurelTOP é um sistema de inovação da produção de tampos de mesa concebidos para atingir a máxima resistência,práticos e elegantes. Os tampos de mesa DurelTOP são formados poruma camada dupla e perfeitamente unida. Produzidos em polipropileno de primeira qualidade, são resistentes ao sol e fáceis de limpar. DurelTOP é o resultado de uma longa investigação tecnológica em materiais plásticos da Nardi, leader em mobiliário de jardim.

DurelTOP — это инновационная система производства столешниц, позволяющая изготавливать практичные, прочные, крепкие и элегантные столешницы. Столешницы DurelTOP обладают высокой плотностью и состоят из двойной панели с мелкопустотным заполнением, полностью закрытой. Изделия из полипропилен высокого качества устойчивы к воде, солнцу и просты в уходе. DurelTOP — это результат многолетних технологических исследований и десятилетнего опыта NARDI в обработке пластмасс, лидера в производстве садовой мебели и контрактном секторе.

alluminio

anodizzato

L'anodizzazione è un processo elettrolitico che aumenta l'ossidazione delle superfici prevenendo la corrosione con uno strato protettivo. Anodizing is an electrolytic procedure that increases oxidation of the surfaces, preventing corrosion with a protective layer. L'anodisation est un procédé électrolytique qui augmente l'oxydation des surfaces empêchant ainsi la corrosion grâce à une couche de protection.

Die Eloxierung ist ein elektrolytischer Prozess, der die Oxydierung der Oberflächen erhöht und der Korrosion mit einer Schutzschicht vorbeugt. La anodización es un proceso electrolítico que aumenta el poder de oxidación de las superficies evitando de esta manera la corrosión mediante una capa protectora. A anodização é um processo electrolítico que aumenta a oxidação

das superficies prevenindo a corrosão com uma camada protectora. Анодирование представляет собой электролитный процесс, который повышает окисление поверхностей, предотвращая коррозию благодаря образованию защитного слоя.

verniciato

La verniciatura è a polvere di poliester. The painting is with polyester powder. La peinture est à poudre de polyester. Die Epoxierung erfolgt mit Polyesterpulver. El pintado se realiza con

polvo de poliéster. O pó de poliéster é usado para envernizar. Окраска производится при помощи порошкового полиэстера.



anodizzato .50



verniciato antracite .52

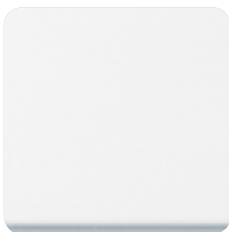

verniciato bianco .53



verniciato caffè' .57



verniciato tortora .59

vetro

Vetro float temperato serigrafato e vetrificato a 700°C. Tempered Float glass, screen-printed and vitrified at 700° C. Verre float trempé sérigraphié et vitrifié à 700°C.

Sicherheitsglas mit innenliegendem Dekorsiebdruck, verglast bei 700°. Vidrio float, templado, serigrafado y vetrificado a 700°C.

Vidro float temperado, impresso e vitrificado a 700°C. Сериграфированное закаленное стекло float, производимое при 700°C.

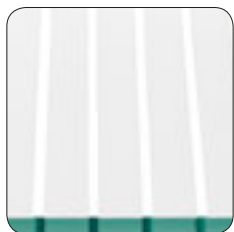

BIANCO .00



ANTRACITE .02



CAFFÈ .05

laminato HPL

Laminato decorativo ad alta pressione, compatto, omogeneo, non poroso, ad alta densità.

HPL-Laminat, beständig, homogen, hoch verdichtet.

Decorativo e laminado a alta pressão, sólido, homogêneo, não poroso e de grande densidade.

Decorative high pressure laminate, solid, homogeneous, non-porous and with a high density.

Laminado decorado a alta presión, compacto, homogéneo, no poroso y de alta densidad.

Декоративный ламинат высокого давления, компактный, однородный, непористый, с высокой плотностью.

Stratifié décoratif à haute pression, condensé, homogène, pas poreux, haute densité.



BIANCO .301



CAFFÈ .302



ANTRACITE .303

tessuto acrilico

Fibra Acrilica 100% tinta in massa. Solidità alla luce 7/8. Sfoderabile/zip, lavabile a 30°.

CUSCINO SEDUTA = imbottitura: poliuretano espanso. Densità 25 kg/m³. CUSCINO ARREDO = imbottitura: poliuretano espanso. Densità 25 kg/m³ rivestito da fibra 100% poliester. Trattamento antimacchia, antimuffa.

100% acrylic fiber mass dyed. Light fastness 7/8. Removeable/zip, washable at 30°.

CUSCINO SEDUTA = padding: polyurethane foam. Density 25 kg/m³. CUSCINO ARREDO = padding: polyurethane foam. Density 25 kg/m³ with polyester fiber 100%. Stain-proof, mould-proof.

100% fibre acrylique teintée en masse. Solidité à la lumière 7/8. Déhoussable/zip, lavable à 30°.

CUSCINO SEDUTA = rembourrage: mousse polyuréthane. Den-

sité 25 kg/m³. CUSCINO ARREDO = rembourrage: mousse polyuréthane. Densité 25 kg/m³ avec fibres de polyester 100%. Traitement anti-taches, anti-moisissure.

100% fasergefärbtes Acryl. Lichtbeständigkeit 7/8. Abziehbarer/zip, waschbar bei 30°.

CUSCINO SEDUTA = polsterung: polyurethanschaum. Dichte 25 kg/m³. CUSCINO ARREDO = polsterung: polyurethanschaum. Dichte 25 kg/m³ beschichtet Polyesterfasern 100%. Mit Anti-Flecken- und Anti-Schimmel-Behandlung.

100% fibra acrílica tintada en masa. Solidez a la luz 7/8. Desenfundable/zip, lavable a 30°.

CUSCINO SEDUTA = relleno: espuma de poliuretano. Densidad 25 kg/m³. CUSCINO ARREDO = relleno: espuma de poliuretano. Densidad 25 kg/m³ cubierta con fibras de poliéster 100%. Trata-

miento antimanchas, antimoho.

100% fibra acrílica tingida em massa. Resistência à luz 7/8. Removível/zip, lavável a 30°.

CUSCINO SEDUTA = acolchoamento: espuma de poliuretano. Densidade 25 kg/m³. CUSCINO ARREDO = acolchoamento: espuma de poliuretano. Densidade 25 kg/m³ com cobertura fibras de poliéster 100%. Tratamento antimancha, antimoho.

100% акриловое волокно, окрашенное в процессе производства. Светостойкость 7/8. Съемная ткань/на молнии, стирка при 30°.

ПОДУШКА СИДЕНИЯ = наполнитель: пенополиуретан. Плотность 25 кг/м³. ПОДУШКА ДЕКОРАТИВНАЯ = наполнитель: пенополиуретан. Плотность 25 кг/м³, обшивка из 100% полиэстера. Обработка против пятен, противогрибковая.



lime .061
240 gr/m²

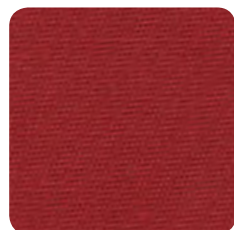

cherry .065
240 gr/m²



melanzana .068
190 gr/m²

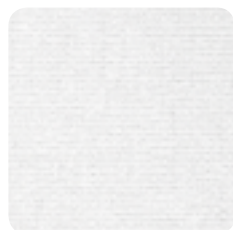

bianco .155
190 gr/m²

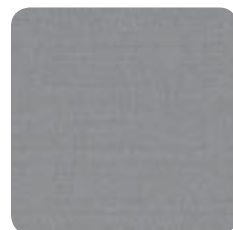

grigio .163
240 gr/m²

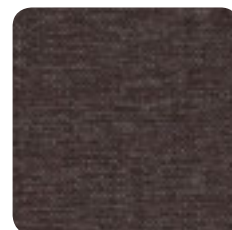

caffè .165
190 gr/m²



arancio .166
190 gr/m²

tessuto sintetico tela 1x1

Tessuto in filo di poliester rivestito in pvc
Fabric is made of a polyester fiber, with a pvc coating.
Tissu en fil de polyester revêtu de pvc

Gewebe aus PVC-ummantelten Polyesterfasern.
Tejido en hilo de poliester recubierto de pvc.
Tecido de fibra polyester com cobertura pvc.

Ткань из полиэфирных нитей с покрытием из ПВХ.

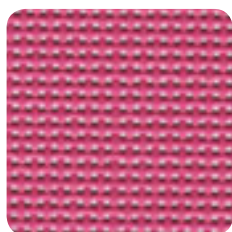

rosa .056



antracite .057

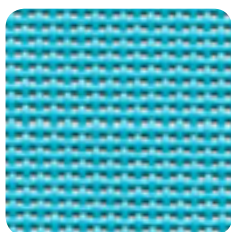

celeste .075



mandarino .083

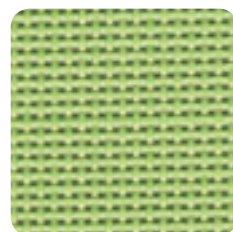

prato .084

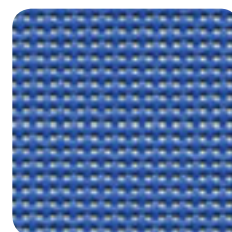

blu .102

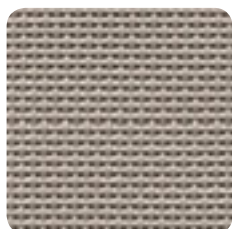

tortora .104

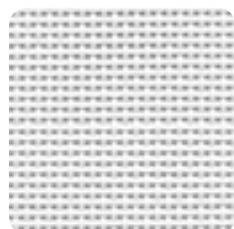

bianco .107

Sui colori scuri, ombre ed altri difetti minori sono più evidenti rispetto ai colori chiari e sono da ritenersi standard. On dark colors, shadows and other minor faults are more evident than on lighter colors and are therefore standard. Sur les couleurs sombres, les ombres et les autres petits défauts sont plus marqués que sur les couleurs claires et sont tout à fait standards. Auf dunklen Farben sind Schatten und andere kleinere Mängel sichtbarer als auf hellen Farben und sind daher als Standard zu betrachten. Las sombras y demás defectos menores son más evidentes sobre los colores oscuros respecto a los colores claros y tienen que considerarse como estándares. Em cores escuras, sombras e outros defeitos menores são mais evidentes do que em cores claras e devem ser considerados standard. По сравнению со светлыми цветами на темных цветах тени и другие небольшие дефекты более заметны и должны считаться нормой.

Il peso (kg), le misure (cm) e i colori riportati sono indicativi. La NARDI si riserva il diritto di apportare modifiche o varianti senza preavviso. Tutti i modelli sono depositati. Weights (kg), dimensions (cm) and colors are indicative only. NARDI reserves the right to make changes or variations without notice. All models are patented. Le poids (kg), les dimensions (cm) et les coloris indiqués sont fournis purement à titre indicatif. La Firme NARDI se réserve le droit d'apporter toute modification ou variation sans aucun préavis. Tous les modèles sont déposés. Alle Farb-, Maß- (cm) und Gewichtsangaben (kg) sind nicht als fest bindend anzusehen Firma NARDI behält sich das Recht von Änderungen. Alle Modelle sind gesetzlich geschützt. El peso (kg), las medidas (cm) y los colores detallados, son indicativos. La firma NARDI se reserva el derecho de modificaciones o variaciones sin previo aviso. Todos los modelos llevan nuestra marca. O peso (kg), as medidas (cm) e as cores indicadas, são indicativos. A NARDI reservase o direito de aportar modificações ou variações sem préaviso. Todos os modelos estão depositados. Приведенный вес (кг), размеры (см) и цвета являются ориентировочными. Компания NARDI оставляет за собой права вносить изменения и вариации без предварительного предупреждения. Все модели зарегистрированы.



YOUR OUTDOOR LIVING

NARDI s.p.a.
Chiampo (VI) Italy
tel. +39 0444 422100
www.nardigarden.com



10101180

2016

